

Switching Regulator Series

Isolated Flyback DC/DC Converter BD7F100EFJ-LB Evaluation Board

BD7F100EFJ-EVK-003 (5V→5V, 0.2A)

BD7F100EFJ-EVK-003 Evaluation board delivers an output 5 volts from an input 5 volts using BD7F100EFJ-LB, Isolated Flyback DC/DC converter integrated circuit, with output current rating of maximum 1A.

Performance specification

These are representative values, and it is not a guaranteed against the characteristics.

$V_{IN} = 5V$, $V_{OUT} = 5V$, Unless otherwise specified.

Parameter	Min	Typ	Max	Units	Conditions
Input Voltage		5.0		V	
Output Voltage		5.0		V	R4=3.9k Ω , R5=13.3k Ω
Output Current Range	3.75		200	mA	Maximum Output Power: 1W
Operating Frequency		400		kHz	
Maximum Efficiency		79.4		%	$I_O = 100mA$

Evaluation Board

PCB size: 70mmx50mmx1.6mm



Figure 1. BD7F100EFJ-EVK-003 Evaluation Board

Top View

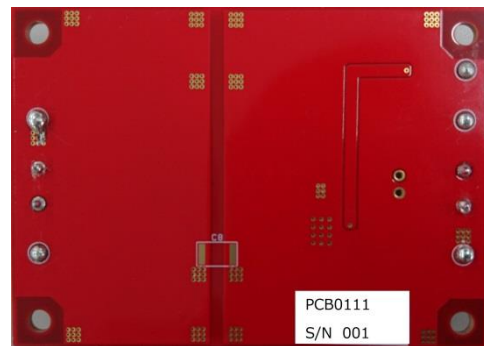

Figure 2. BD7F100EFJ-EVK-003 Evaluation Board

Bottom View

Operation Procedures

1. Necessary equipments

- (1) DC power-supply of 5V/0.5A
- (2) Maximum 200mA load
- (3) DC voltmeter

2. Connecting the equipments

- (1) DC power-supply presets to 5V and then the power output turns off.
- (2) The maximum load should be set at 200mA and over it will be disabled.
- (3) Connect positive-terminal of power-supply to VIN terminal and negative-terminal to GND terminal with a pair of wires.
- (4) Connect load's positive-terminal to VOUT+ terminal and negative-terminal to VOUT- terminal with a pair of wires.
- (5) Connect positive-terminal of DC voltmeter 1 to VIN and negative-terminal to GND for input-voltage measurement.
- (6) Connect positive-terminal of DC voltmeter 2 to VOUT+ and negative-terminal to VOUT- for output-voltage measurement.
- (7) DC power-supply output is turned ON.
- (8) Check DC voltmeter 2 displays 5V.
- (9) The load is enabled.

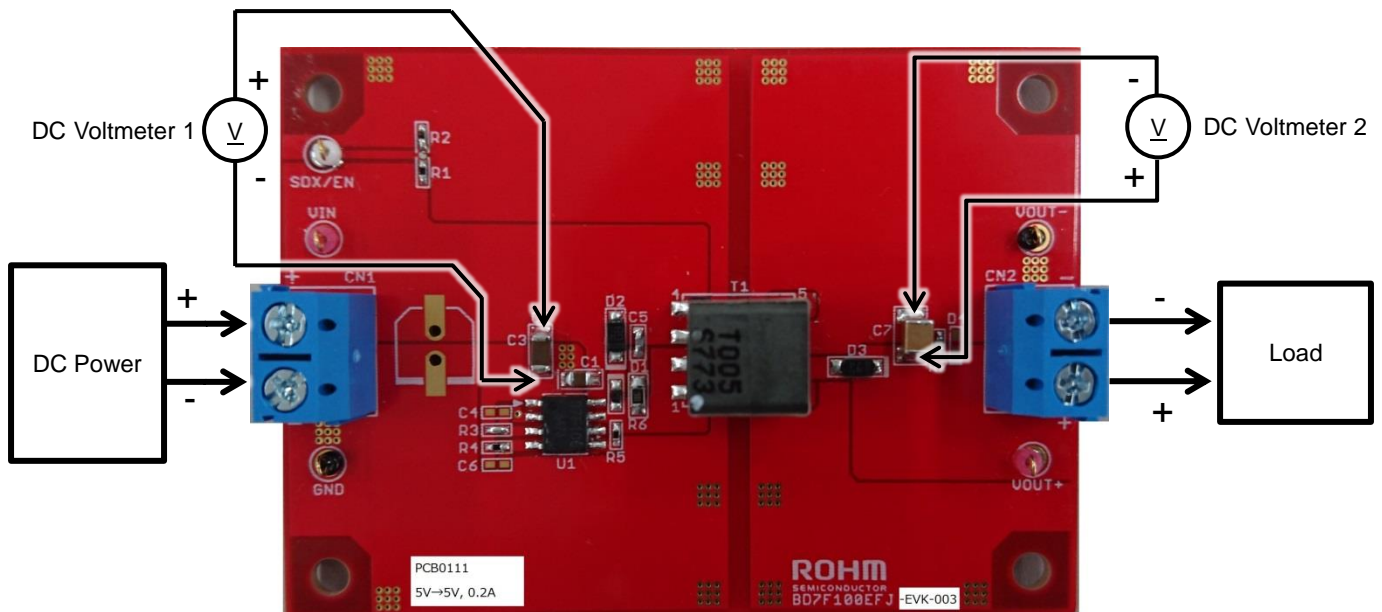

Figure 3. Connection Diagram

Circuit Diagram

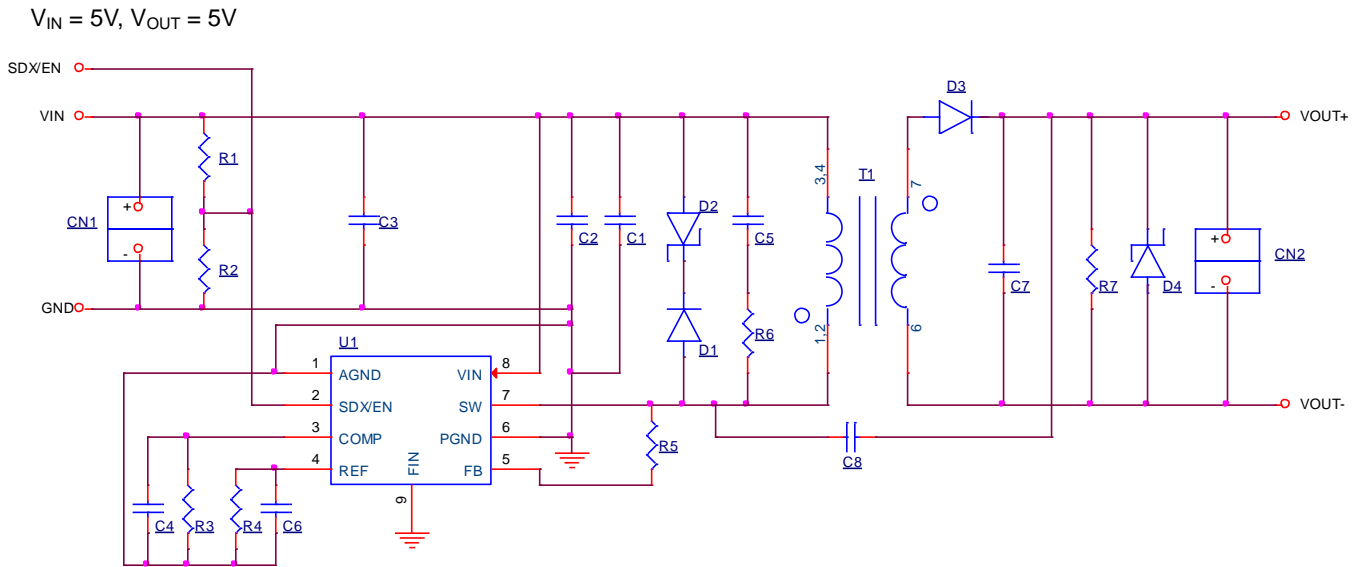

Figure 4. BD7F100EFJ-EVK-003 Circuit Diagram

Bill of Materials

No.	Value	Description	Size	Part Number / Series	Manufacturer
C1	1 μ F	Capacitor, Chip, 50V, X7R	2012	GRM21BR71H105KA12L	MURATA
C2	4.7 μ F	Capacitor, Chip, 50V, X7R	3216	GRM31CR71H475KA12L	MURATA
C3	-	Notinstalled	-	-	-
C4	-	Notinstalled	-	-	-
C5	1000pF	Capacitor, Chip, 50V, CH	1005	GRM1552C1H102JA01	MURATA
C6	-	Notinstalled	-	-	-
C7	22 μ F	Capacitor, Chip, 25V, X7R	3225	GRM32ER71E226KE15L	MURATA
C8	-	Notinstalled	-	-	-
D1	1SS400SM	Diode	1608	1SS400SM	ROHM
D2	KDZ3.6B	Diode, Zener, Vz=3.60~4.00V	3516	KDZ3.6B	ROHM
D3	RB160MM-40	Diode, Schottky	3516	RB160MM-40	ROHM
D4	-	Notinstalled	-	-	-
R1	510k Ω	Resistor, Chip, 1/16W, 1%	1005	MCR01MZPF5103	ROHM
R2	680k Ω	Resistor, Chip, 1/16W, 1%	1005	MCR01MZPF6803	ROHM
R3	-	Short	-	-	-
R4	3.9k Ω	Resistor, Chip, 1/16W, 1%	1005	MCR01MZPF3901	ROHM
R5	13.3k Ω	Resistor, Chip, 1/16W, 1%	1005	MCR01MZPF1332	ROHM
R6	200 Ω	Resistor, Chip, 1/8W, 1%	2012	MCR10EZPF2000	ROHM
R7	1k Ω	Resistor, Chip, 1/16W, 1%	1005	MCR01MZPF1001	ROHM
T1	10 μ H	Transformer, Np:Ns=1:2, \pm 20%	10.0 x 10.0 x 11.5mm	CEP911B-0505051R	sumida
U1	BD7F100EFJ	I.C. BD7F100EFJ	HTSOP-J8	BD7F100EFJ	ROHM

Layout

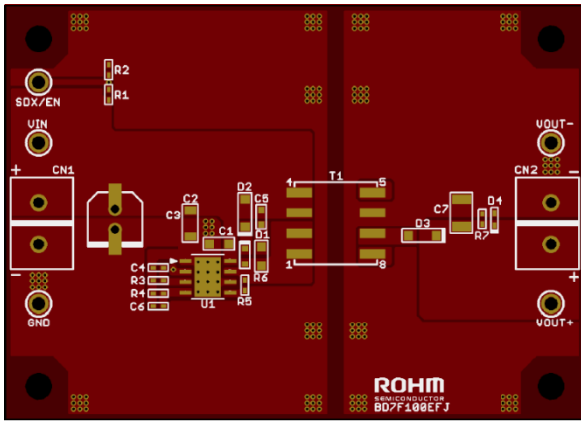

Figure 5. Top Silk Screen and Layout
(Top View)

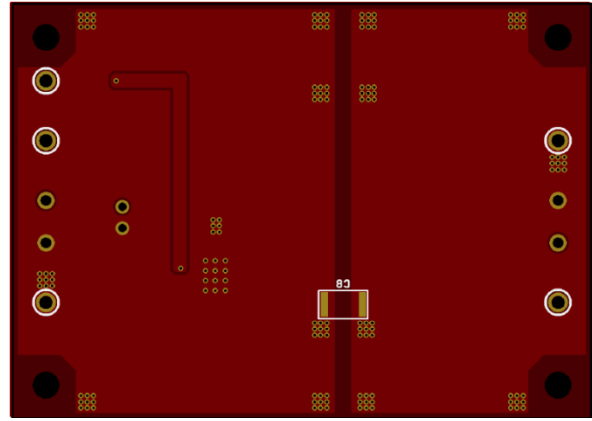

Figure 6. Bottom Silk Screen and Layout
(Top View)

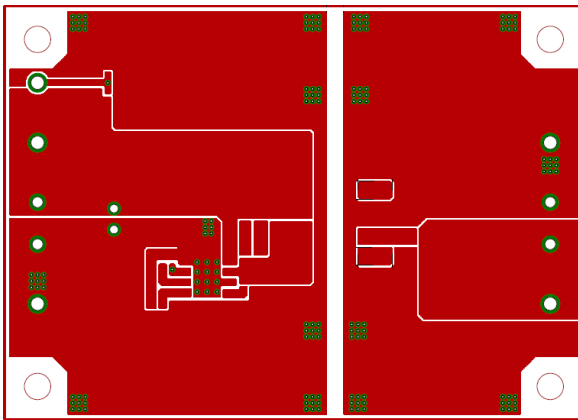

Figure 7. Top Side Layout
(Top View)

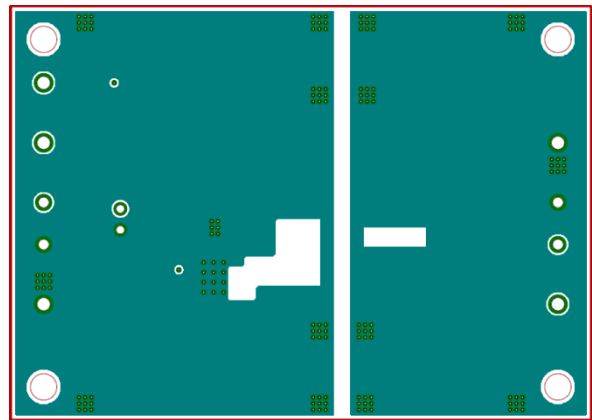

Figure 8. Middle Layer1 Layout
(Top View)

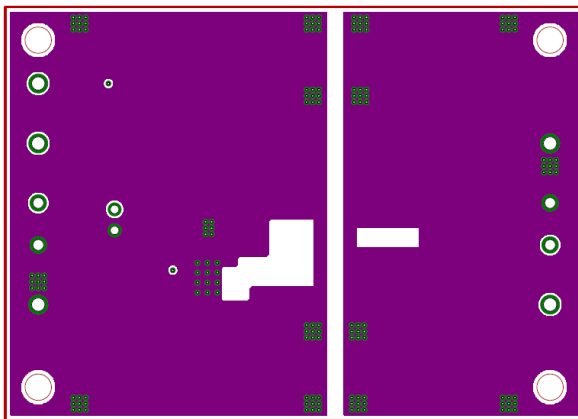

Figure 9. Middle Layer2 Layout
(Top View)

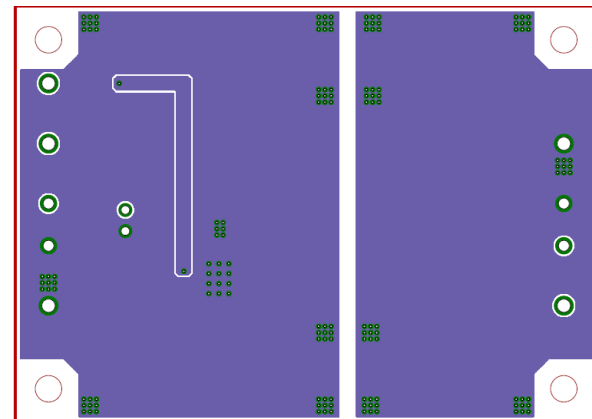

Figure 10. Bottom Side Layer Layout
(Top View)

Reference Application Data

$V_{IN} = 5V$, $V_{OUT} = 5V$

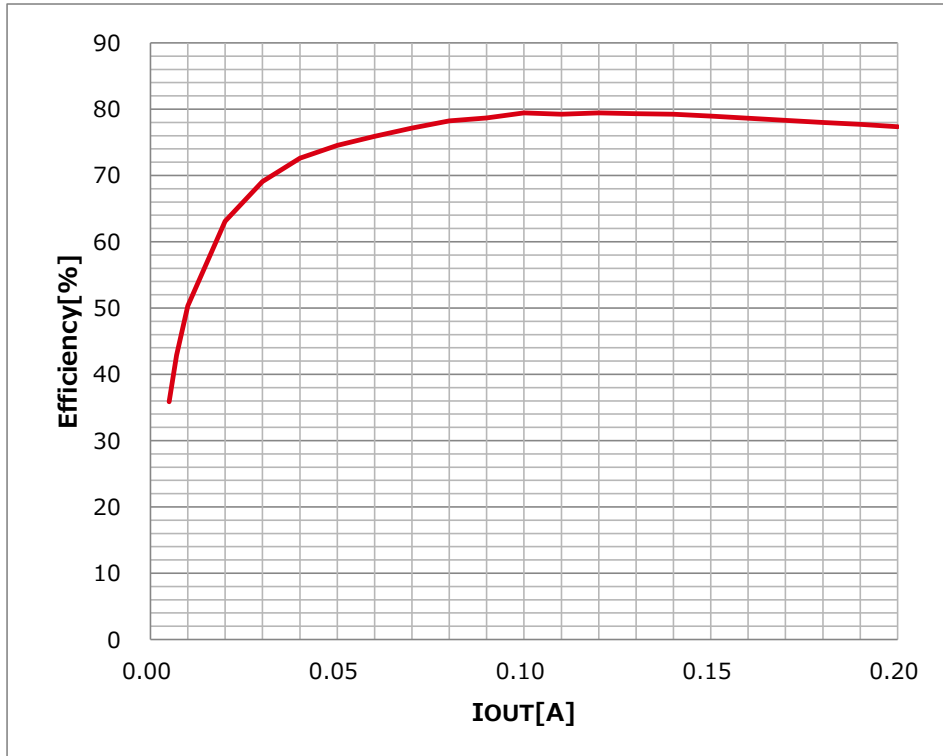

Figure 11. Efficiency vs Load Current

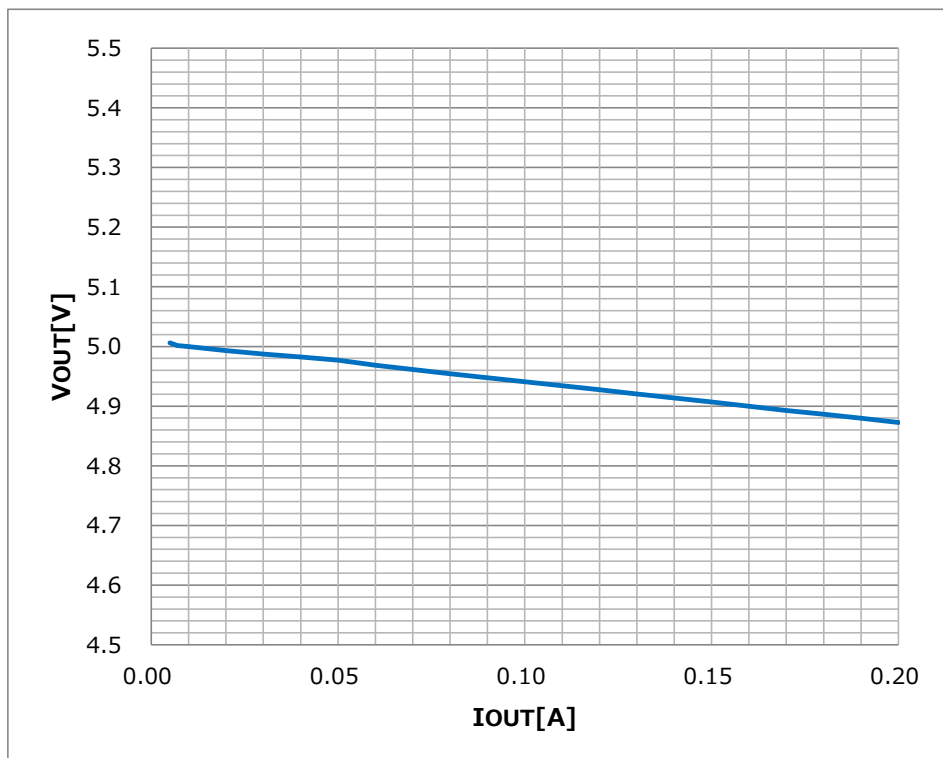

Figure 12. Load Regulation

Notes

- 1) The information contained herein is subject to change without notice.
- 2) Before you use our Products, please contact our sales representative and verify the latest specifications :
- 3) Although ROHM is continuously working to improve product reliability and quality, semiconductors can break down and malfunction due to various factors.
Therefore, in order to prevent personal injury or fire arising from failure, please take safety measures such as complying with the derating characteristics, implementing redundant and fire prevention designs, and utilizing backups and fail-safe procedures. ROHM shall have no responsibility for any damages arising out of the use of our Products beyond the rating specified by ROHM.
- 4) Examples of application circuits, circuit constants and any other information contained herein are provided only to illustrate the standard usage and operations of the Products. The peripheral conditions must be taken into account when designing circuits for mass production.
- 5) The technical information specified herein is intended only to show the typical functions of and examples of application circuits for the Products. ROHM does not grant you, explicitly or implicitly, any license to use or exercise intellectual property or other rights held by ROHM or any other parties. ROHM shall have no responsibility whatsoever for any dispute arising out of the use of such technical information.
- 6) The Products specified in this document are not designed to be radiation tolerant.
- 7) For use of our Products in applications requiring a high degree of reliability (as exemplified below), please contact and consult with a ROHM representative : transportation equipment (i.e. cars, ships, trains), primary communication equipment, traffic lights, fire/crime prevention, safety equipment, medical systems, servers, solar cells, and power transmission systems.
- 8) Do not use our Products in applications requiring extremely high reliability, such as aerospace equipment, nuclear power control systems, and submarine repeaters.
- 9) ROHM shall have no responsibility for any damages or injury arising from non-compliance with the recommended usage conditions and specifications contained herein.
- 10) ROHM has used reasonable care to ensure the accuracy of the information contained in this document. However, ROHM does not warrants that such information is error-free, and ROHM shall have no responsibility for any damages arising from any inaccuracy or misprint of such information.
- 11) Please use the Products in accordance with any applicable environmental laws and regulations, such as the RoHS Directive. For more details, including RoHS compatibility, please contact a ROHM sales office. ROHM shall have no responsibility for any damages or losses resulting non-compliance with any applicable laws or regulations.
- 12) When providing our Products and technologies contained in this document to other countries, you must abide by the procedures and provisions stipulated in all applicable export laws and regulations, including without limitation the US Export Administration Regulations and the Foreign Exchange and Foreign Trade Act.
- 13) This document, in part or in whole, may not be reprinted or reproduced without prior consent of ROHM.



Thank you for your accessing to ROHM product informations.
More detail product informations and catalogs are available, please contact us.

ROHM Customer Support System

<http://www.rohm.com/contact/>