

Switching Regulator Series

Isolated Flyback DC/DC Converter BD7F100HFN-LB Evaluation Board

BD7F100HFN-EVK-002 (24V→5V, 1A)

BD7F100HFN-EVK-002 Evaluation board delivers an output 5 volts from an input 24 volts using BD7F100HFN-LB, Isolated Flyback DC/DC converter integrated circuit, with output current rating of maximum 1A.

Performance specification

These are representative values, and it is not a guaranteed against the characteristics.

$V_{IN} = 24V$, $V_{OUT} = 5V$, Unless otherwise specified.

| Parameter | Min | Typ | Max | Units | Conditions |
|----------------------|------|------|------|-------|--------------------------------------|
| Input Voltage | | 24.0 | | V | |
| Output Voltage | | 5.0 | | V | R4=3.9k Ω , R5=80.6k Ω |
| Output Current Range | 13.8 | | 1000 | mA | Maximum Output Power:5W |
| Operating Frequency | | 400 | | kHz | |
| Maximum Efficiency | | 77.5 | | % | $I_O = 1000mA$ |

Evaluation Board

PCB size: 70mmx50mmx1.6mm



Figure 1. BD7F100HFN-EVK-002 Evaluation Board

Top View

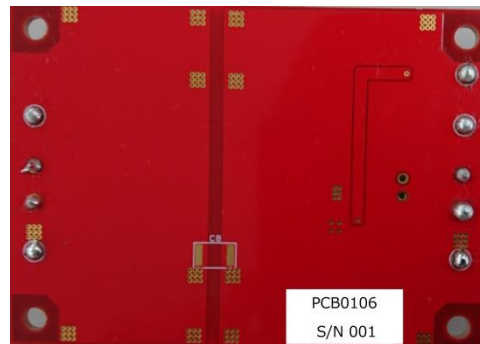

Figure 2. BD7F100HFN-EVK-002 Evaluation Board

Bottom View

Operation Procedures

1. Necessary equipments

- (1) DC power-supply of 24V / 0.5A
- (2) Maximum 1A load
- (3) DC voltmeter

2. Connecting the equipments

- (1) DC power-supply presets to 24V and then the power output turns off.
- (2) The maximum load should be set at 1A and over it will be disabled.
- (3) Connect positive-terminal of power-supply to VIN terminal and negative-terminal to GND terminal with a pair of wires.
- (4) Connect load's positive-terminal to VOUT+ terminal and negative-terminal to VOUT- terminal with a pair of wires.
- (5) Connect positive-terminal of DC voltmeter 1 to VIN and negative-terminal to GND for input-voltage measurement.
- (6) Connect positive-terminal of DC voltmeter 2 to VOUT+ and negative-terminal to VOUT- for output-voltage measurement.
- (7) DC power-supply output is turned ON.
- (8) Check DC voltmeter 2 displays 5V.
- (9) The load is enabled.

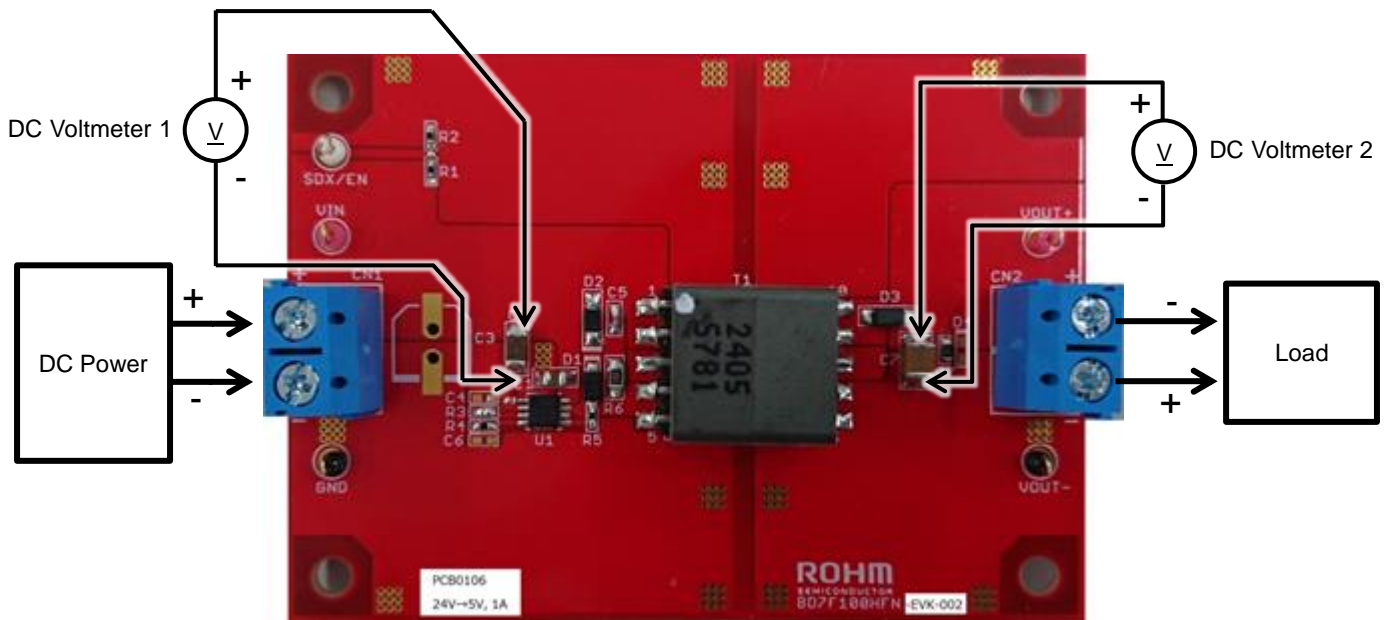

Figure 3. Connection Diagram

Circuit Diagram

 $V_{IN} = 24V, V_{OUT} = 5V$

Figure 4. BD7F100HFN-EVK-002 Circuit Diagram

Bill of Materials

| No. | Value | Description | Size | Part Number / Series | Manufacturer |
|-----|----------------|-----------------------------------|----------------------|----------------------|--------------|
| C1 | 1 μ F | Capacitor, Chip, 50V, X7R | 2012 | GRM21BR71H105KA12L | MURATA |
| C2 | 4.7 μ F | Capacitor, Chip, 50V, X7R | 3216 | GRM31CR71H475KA12L | MURATA |
| C3 | - | Notinstalled | - | - | - |
| C4 | - | Notinstalled | - | - | - |
| C5 | 1000pF | Capacitor, Chip, 50V, CH | 1608 | GRM1882C1H102JA01 | MURATA |
| C6 | - | Notinstalled | - | - | - |
| C7 | 47 μ F | Capacitor, Chip, 10V, X7R | 3225 | GRM32ER71A476KE15 | MURATA |
| C8 | - | Notinstalled | - | - | - |
| D1 | RB160MM-40 | Diode, Schottky | 3516 | RB160MM-40 | ROHM |
| D2 | TFZ20B | Diode, Zener, Vz=18.63~19.59V | 2514 | TFZ20B | ROHM |
| D3 | RB160MM-40 | Diode, Schottky | 3516 | RB160MM-40 | ROHM |
| D4 | - | Notinstalled | - | - | - |
| R1 | 1M Ω | Resistor, Chip, 1/16W, 1% | 1005 | MCR01MZPF1004 | ROHM |
| R2 | 120k Ω | Resistor, Chip, 1/16W, 1% | 1005 | MCR01MZPF1203 | ROHM |
| R3 | - | Short | - | - | - |
| R4 | 3.9k Ω | Resistor, Chip, 1/16W, 1% | 1005 | MCR01MZPF3901 | ROHM |
| R5 | 80.6k Ω | Resistor, Chip, 1/16W, 1% | 1005 | MCR01MZPF8062 | ROHM |
| R6 | 1k Ω | Resistor, Chip, 2/5W, 1% | 2012 | ESR10EZPF1001 | ROHM |
| R7 | 330 Ω | Resistor, Chip, 1/10W, 1% | 1608 | MCR03EZPF3300 | ROHM |
| T1 | 63 μ H | Transformer, Np:Ns=3:1, \pm 20% | 13.5 x 20.0 x 12.5mm | CEP1311D-2405051R | sumida |
| U1 | BD7F100HFN | I.C. BD7F100HFN | HSON8 | BD7F100HFN | ROHM |

Layout

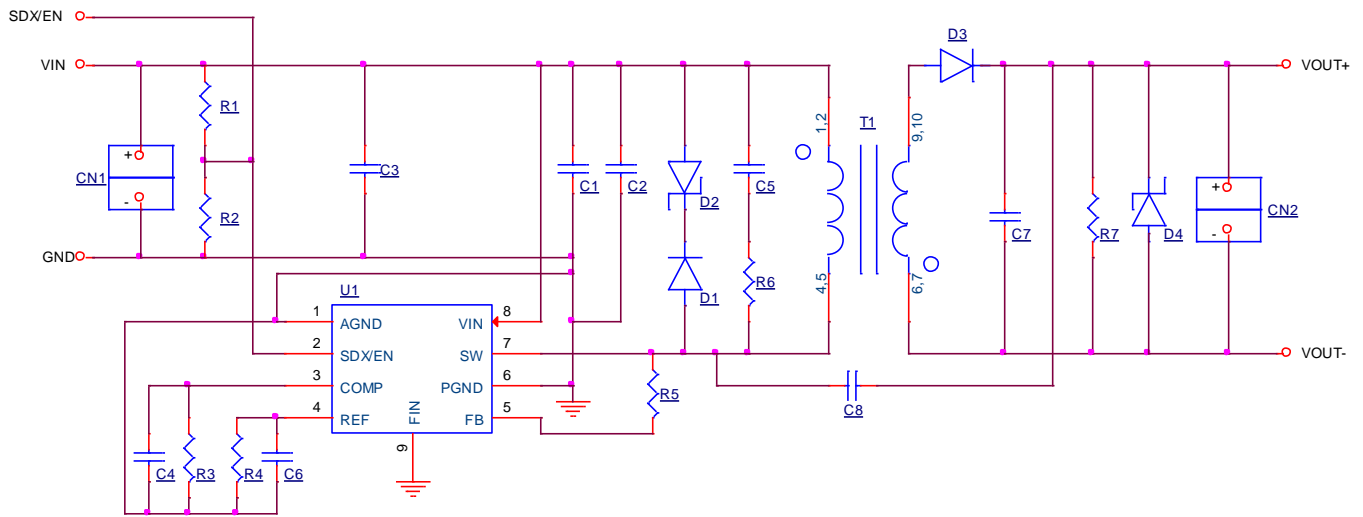
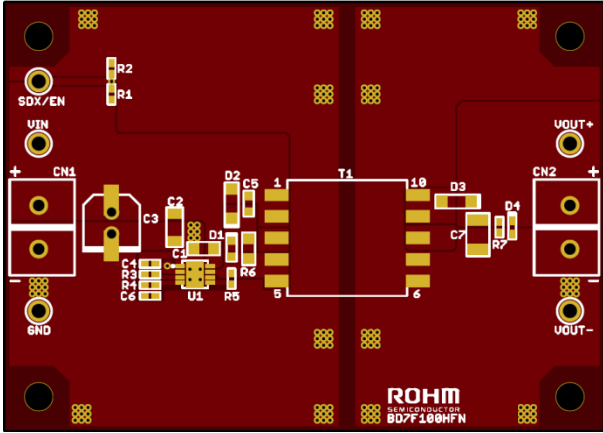

Figure 5. Top Silk Screen and Layout
(Top View)

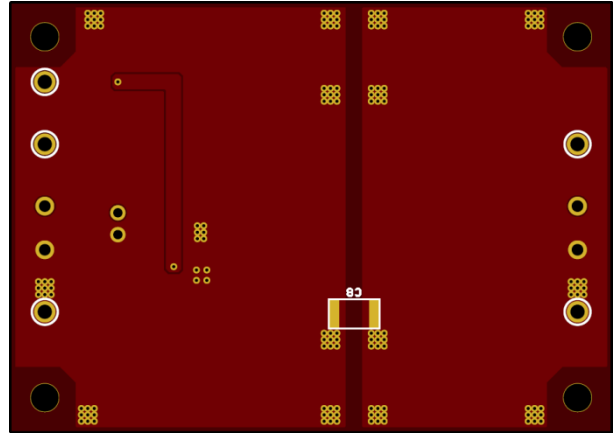

Figure 6. Bottom Silk Screen and Layout
(Top View)

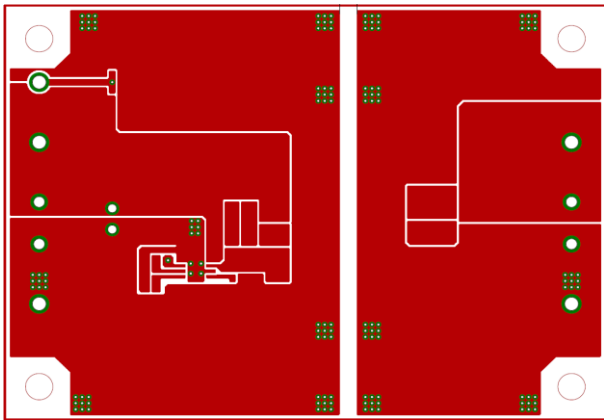

Figure 7. Top Side Layout
(Top View)

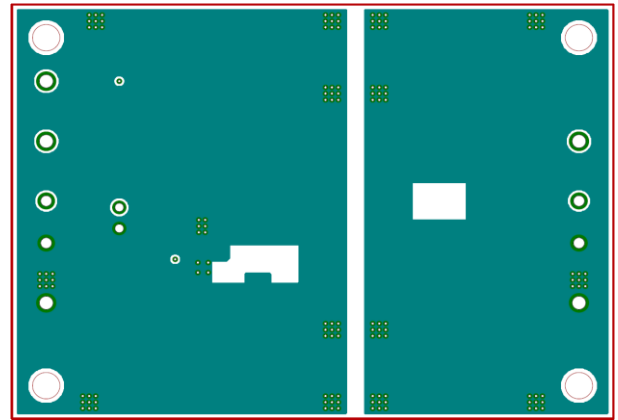

Figure 8. Middle Layer1 Layout
(Top View)

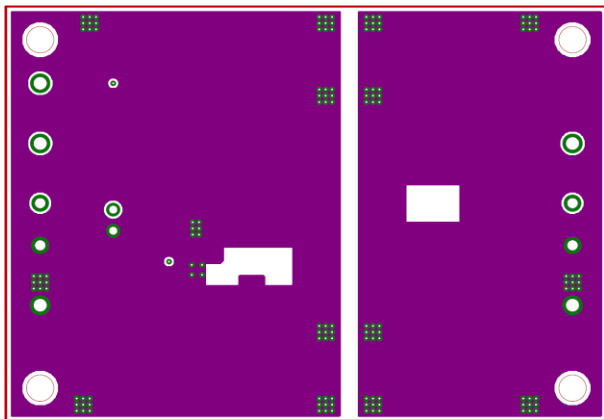

Figure 9. Middle Layer2 Layout
(Top View)

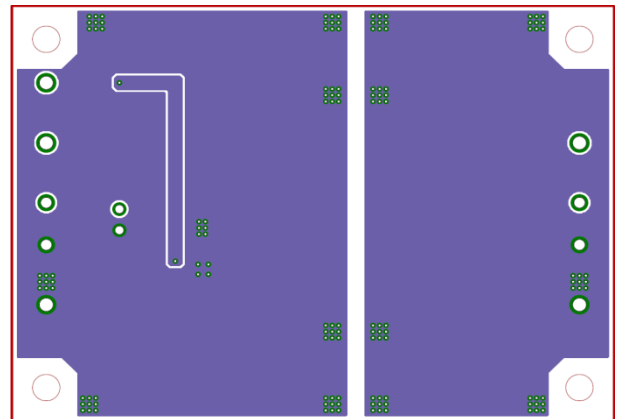

Figure 10. Bottom Side Layer Layout
(Top View)

Reference Application Data

$V_{IN} = 24V$, $V_{OUT} = 5V$

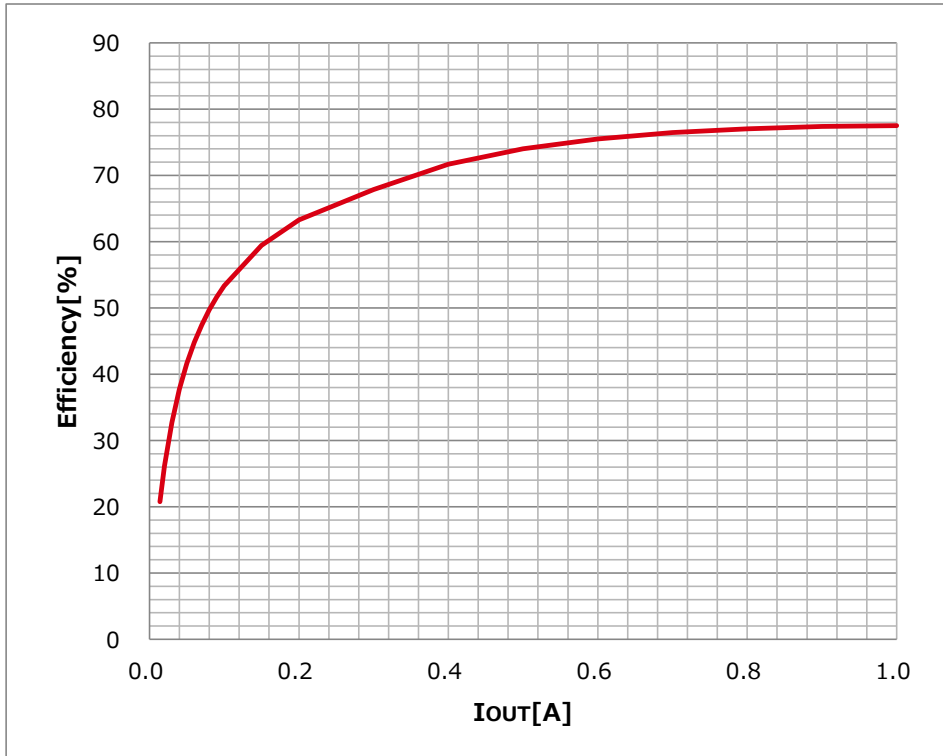

Figure 11. Efficiency vs Load Current

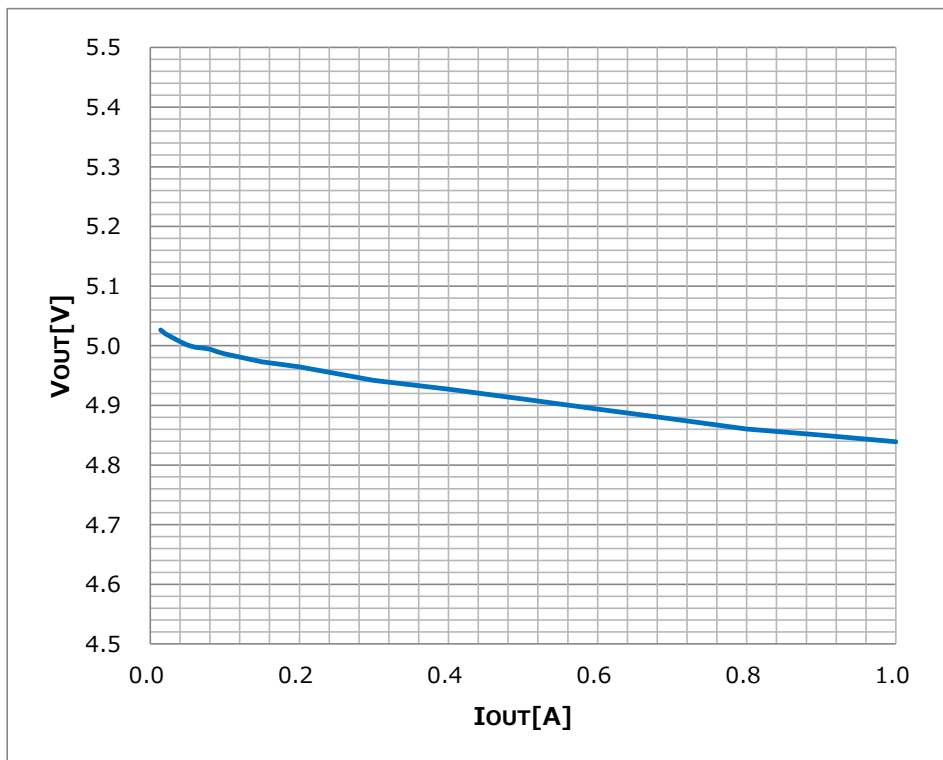

Figure 12. Load Regulation

Notes

- 1) The information contained herein is subject to change without notice.
- 2) Before you use our Products, please contact our sales representative and verify the latest specifications :
- 3) Although ROHM is continuously working to improve product reliability and quality, semiconductors can break down and malfunction due to various factors.
Therefore, in order to prevent personal injury or fire arising from failure, please take safety measures such as complying with the derating characteristics, implementing redundant and fire prevention designs, and utilizing backups and fail-safe procedures. ROHM shall have no responsibility for any damages arising out of the use of our Products beyond the rating specified by ROHM.
- 4) Examples of application circuits, circuit constants and any other information contained herein are provided only to illustrate the standard usage and operations of the Products. The peripheral conditions must be taken into account when designing circuits for mass production.
- 5) The technical information specified herein is intended only to show the typical functions of and examples of application circuits for the Products. ROHM does not grant you, explicitly or implicitly, any license to use or exercise intellectual property or other rights held by ROHM or any other parties. ROHM shall have no responsibility whatsoever for any dispute arising out of the use of such technical information.
- 6) The Products specified in this document are not designed to be radiation tolerant.
- 7) For use of our Products in applications requiring a high degree of reliability (as exemplified below), please contact and consult with a ROHM representative : transportation equipment (i.e. cars, ships, trains), primary communication equipment, traffic lights, fire/crime prevention, safety equipment, medical systems, servers, solar cells, and power transmission systems.
- 8) Do not use our Products in applications requiring extremely high reliability, such as aerospace equipment, nuclear power control systems, and submarine repeaters.
- 9) ROHM shall have no responsibility for any damages or injury arising from non-compliance with the recommended usage conditions and specifications contained herein.
- 10) ROHM has used reasonable care to ensure the accuracy of the information contained in this document. However, ROHM does not warrants that such information is error-free, and ROHM shall have no responsibility for any damages arising from any inaccuracy or misprint of such information.
- 11) Please use the Products in accordance with any applicable environmental laws and regulations, such as the RoHS Directive. For more details, including RoHS compatibility, please contact a ROHM sales office. ROHM shall have no responsibility for any damages or losses resulting non-compliance with any applicable laws or regulations.
- 12) When providing our Products and technologies contained in this document to other countries, you must abide by the procedures and provisions stipulated in all applicable export laws and regulations, including without limitation the US Export Administration Regulations and the Foreign Exchange and Foreign Trade Act.
- 13) This document, in part or in whole, may not be reprinted or reproduced without prior consent of ROHM.



Thank you for your accessing to ROHM product informations.
More detail product informations and catalogs are available, please contact us.

ROHM Customer Support System

<http://www.rohm.com/contact/>

<High Voltage Safety Precautions>

◇ Read all safety precautions before use

Please note that this document covers only the BD7F100HFN-LB evaluation board (BD7F100HFN-EVK-002) and its functions. For additional information, please refer to the datasheet.

To ensure safe operation, please carefully read all precautions before handling the evaluation board



Depending on the configuration of the board and voltages used,
Potentially lethal voltages may be generated.
Therefore, please make sure to read and observe all safety precautions described in the red box below.

Before Use

- [1] Verify that the parts/components are not damaged or missing (i.e. due to the drops).
- [2] Check that there are no conductive foreign objects on the board.
- [3] Be careful when performing soldering on the module and/or evaluation board to ensure that solder splash does not occur.
- [4] Check that there is no condensation or water droplets on the circuit board.

During Use

- [5] Be careful to not allow conductive objects to come into contact with the board.
- [6] **Brief accidental contact or even bringing your hand close to the board may result in discharge and lead to severe injury or death. Therefore, DO NOT touch the board with your bare hands or bring them too close to the board.**
In addition, as mentioned above please exercise extreme caution when using conductive tools such as tweezers and screwdrivers.
- [7] If used under conditions beyond its rated voltage, it may cause defects such as short-circuit or, depending on the circumstances, explosion or other permanent damages.
- [8] Be sure to wear insulated gloves when handling is required during operation.

After Use

- [9] The ROHM Evaluation Board contains the circuits which store the high voltage. Since it stores the charges even after the connected power circuits are cut, please discharge the electricity after using it, and please deal with it after confirming such electric discharge.
- [10] Protect against electric shocks by wearing insulated gloves when handling.

This evaluation board is intended for use only in research and development facilities and should be handled **only by qualified personnel familiar with all safety and operating procedures.**

We recommend carrying out operation in a safe environment that includes the use of high voltage signage at all entrances, safety interlocks, and protective glasses.