

Linear Regulator Series

BAxxCC0 Series Typical Performance Curves

No.AEK59-D1-0087-1

LIST

BA03CC0 ($V_o=3.0V$)	2
BA033CC0 ($V_o=3.3V$)	6
BA05CC0 ($V_o=5.0V$)	10
BA06CC0 ($V_o=6.0V$)	14
BA07CC0 ($V_o=7.0V$)	18
BA08CC0 ($V_o=8.0V$)	22
BA09CC0 ($V_o=9.0V$)	26
BAJ0CC0 ($V_o=10V$)	30
BAJ2CC0 ($V_o=12V$)	34
BAJ5CC0 ($V_o=15V$)	38
Test Circuits.....	42

BA03CC0 ($V_o=3.0V$)

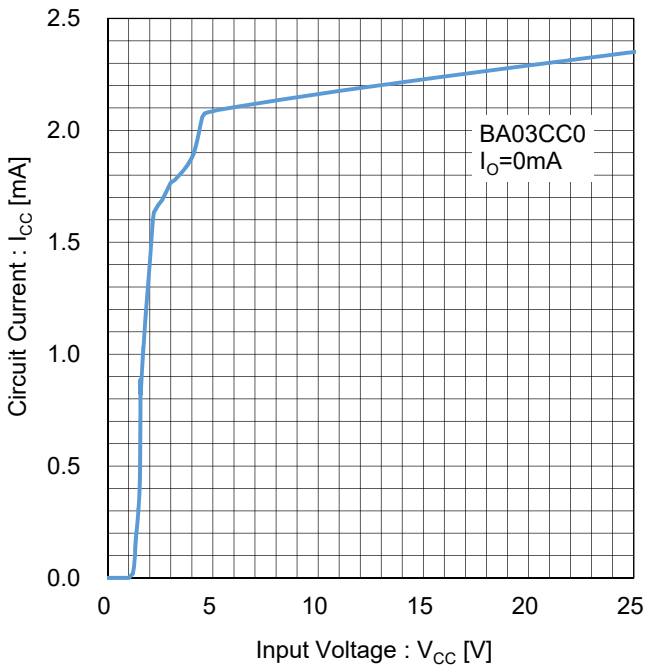

Figure 1. Circuit Current
Test Circuit A

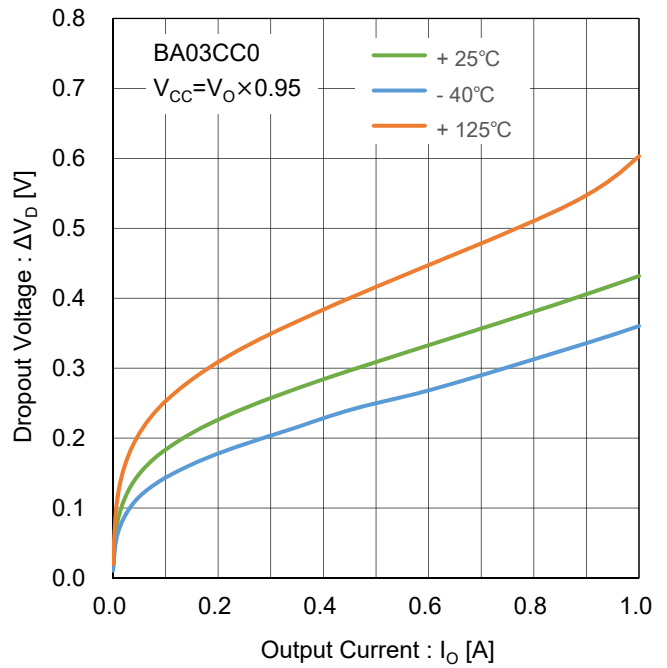

Figure 2. Dropout Voltage vs Output Current
Test Circuit B

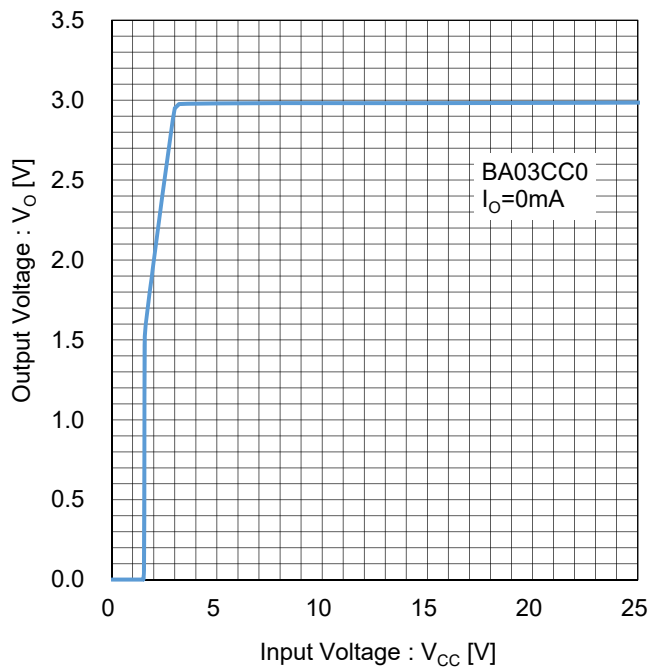

Figure 3. Output Voltage vs Input Voltage
($I_o=0mA$)
Test Circuit C

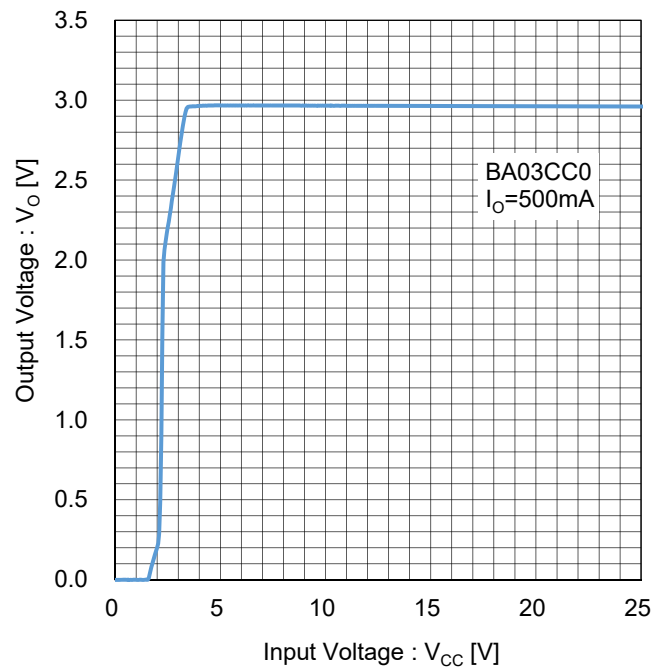

Figure 4. Output Voltage vs Input Voltage
($I_o=500mA$)
Test Circuit C

BA03CC0 (V_O=3.0V)

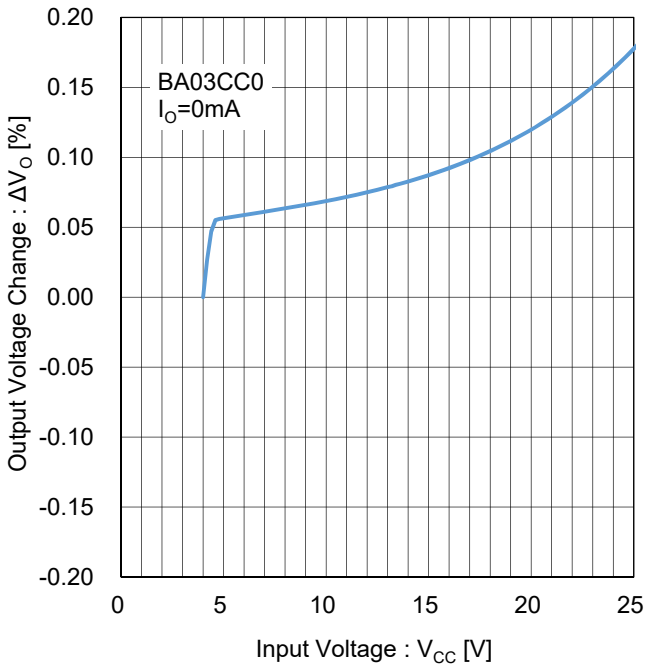

Figure 5. Line Regulation
(I_o=0mA)
Test Circuit D

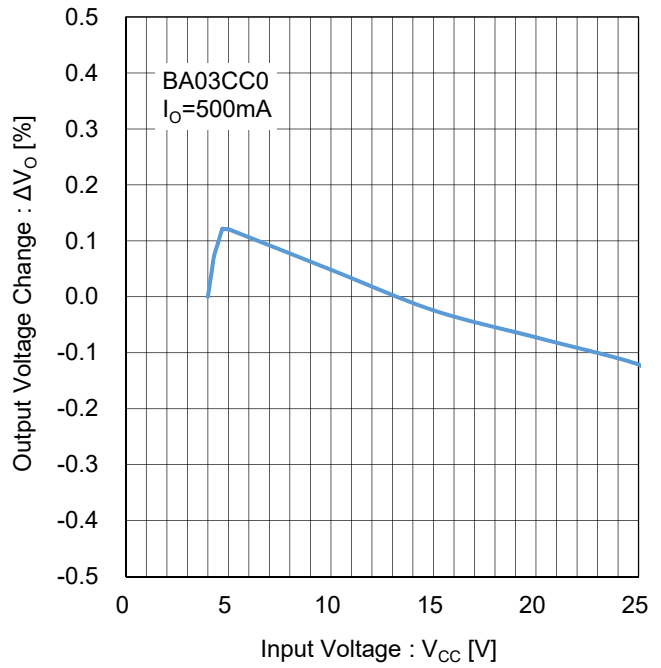

Figure 6. Line Regulation
(I_o=500mA)
Test Circuit D

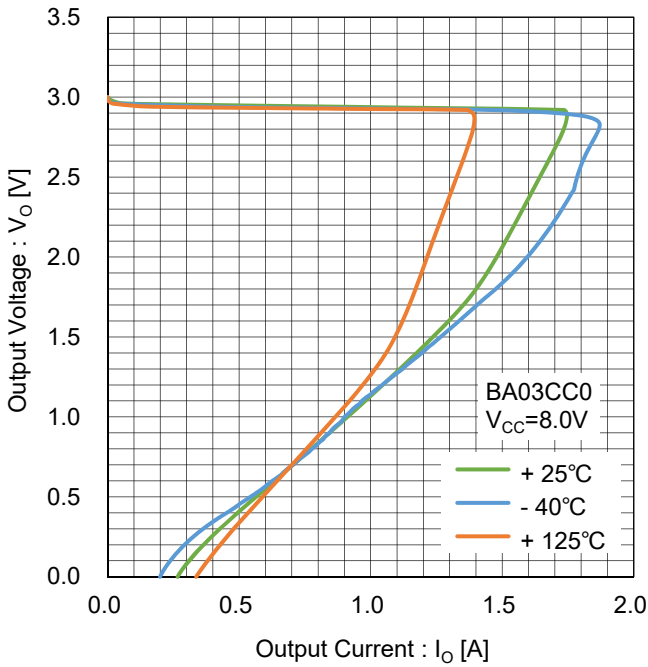

Figure 7. Overcurrent Protection
Test Circuit E

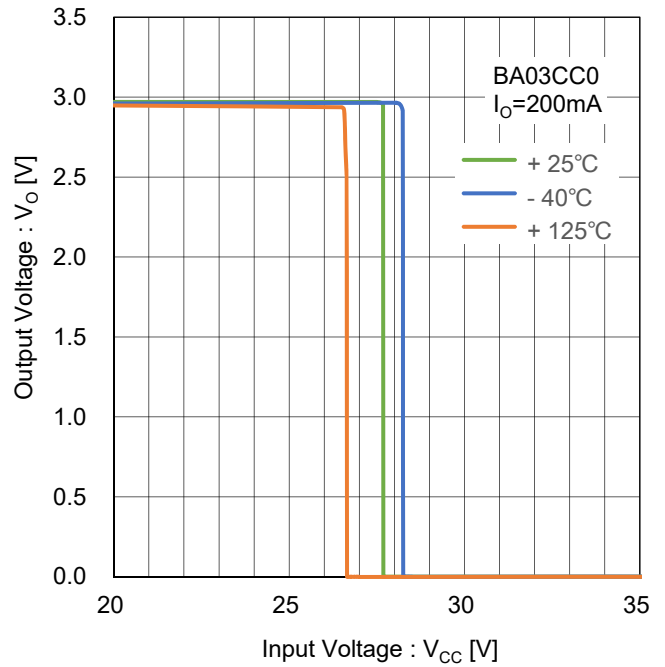

Figure 8. Overvoltage Protection
Test Circuit F

BA03CC0 ($V_O=3.0V$)

Refer to the data of BA033CC0

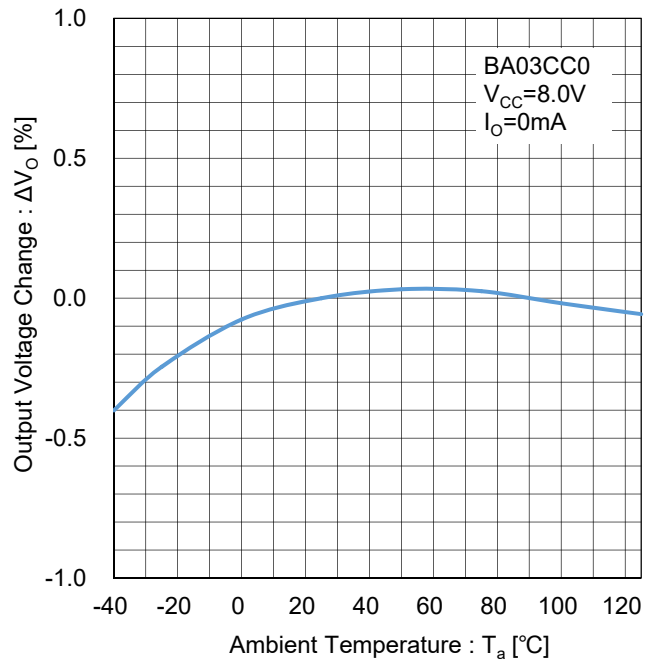

Figure 10. Output Voltage Temperature Stability Test Circuit H

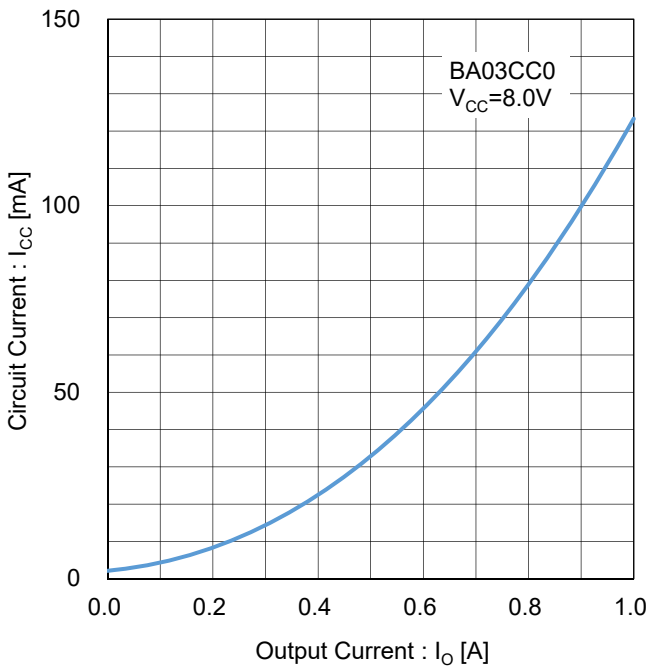

Figure 11. Circuit Current vs Output Current Test Circuit I

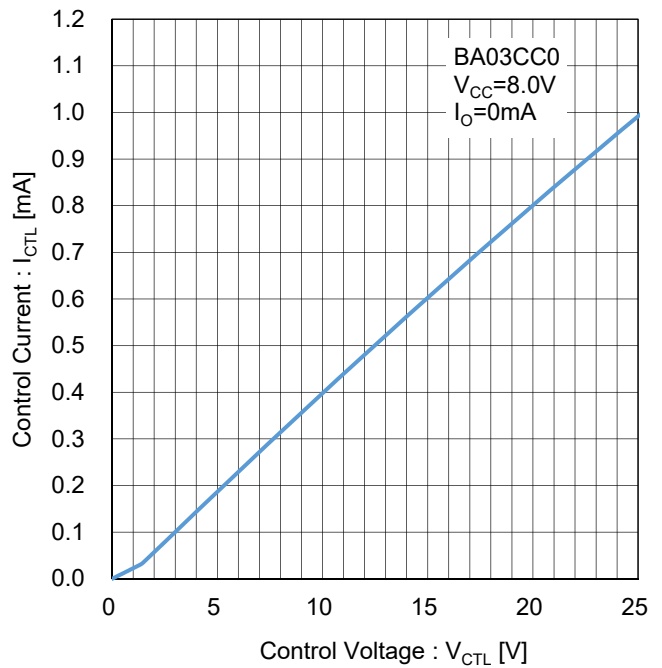

Figure 12. CTL Pin Current Test Circuit J

BA03CC0 (V_O=3.0V)

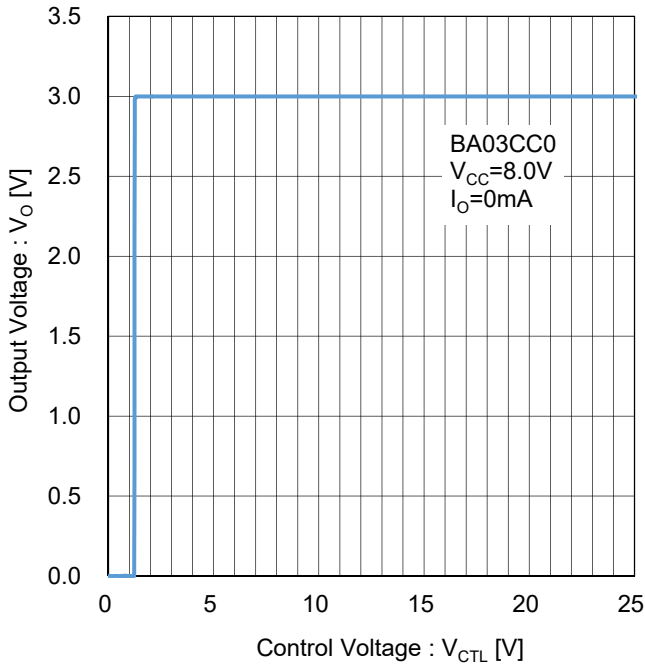

Figure 13. Output Voltage vs CTL Pin Voltage
Test Circuit K

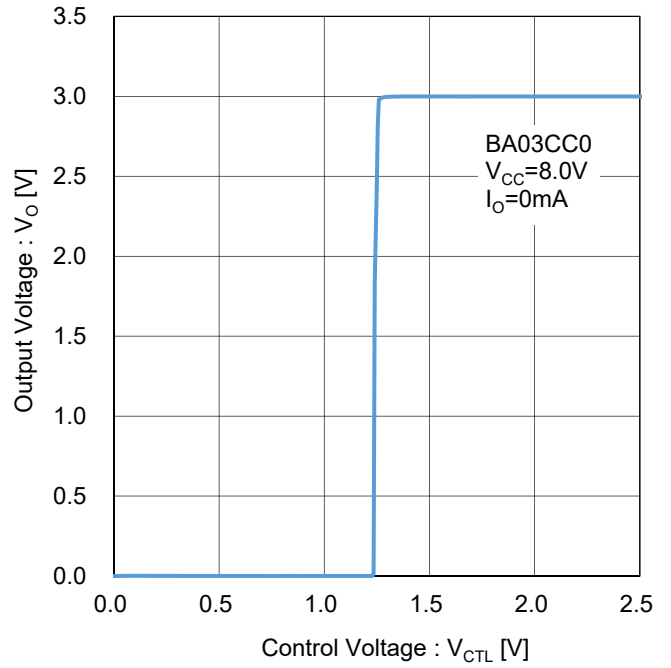

Figure 14. Output Voltage vs CTL Pin Voltage
Test Circuit K

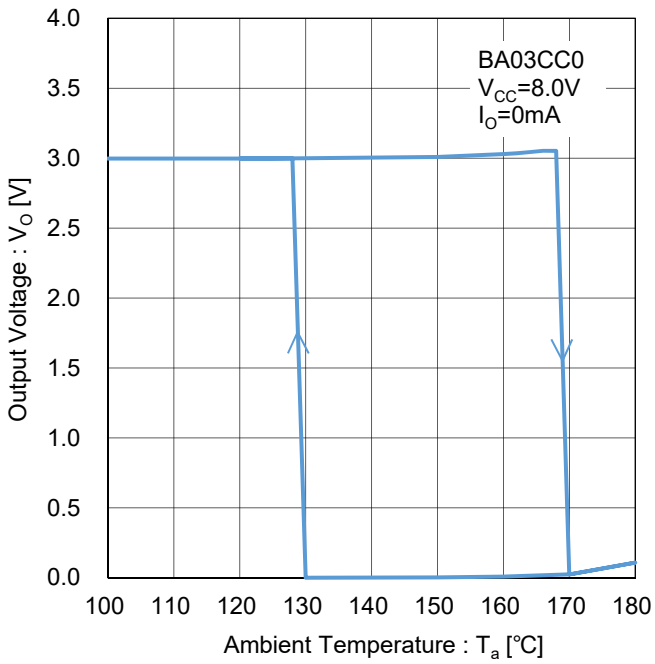

Figure 15. Thermal Shutdown
Test Circuit L

BA033CC0 ($V_o=3.3V$)

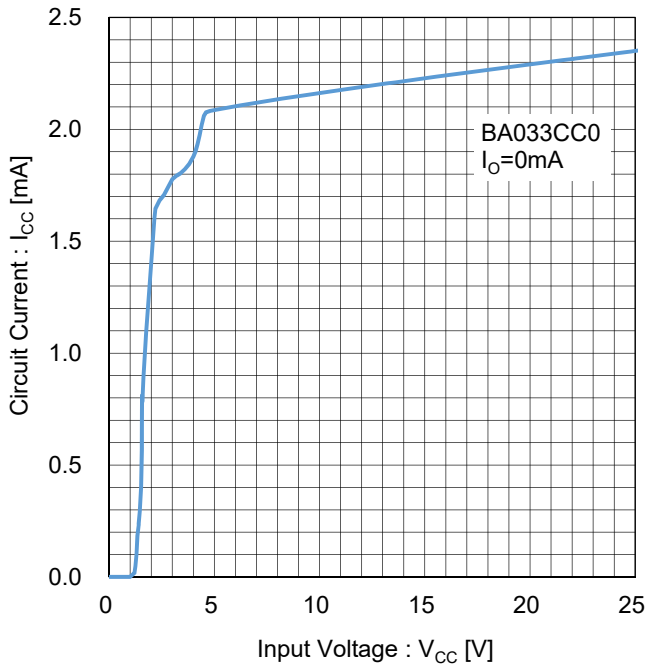

Figure 16. Circuit Current
Test Circuit A

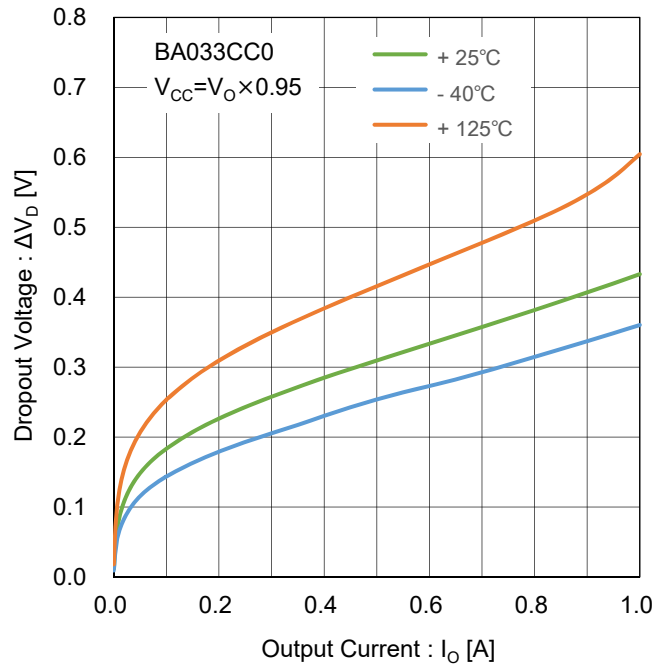

Figure 17. Dropout Voltage vs Output Current
Test Circuit B

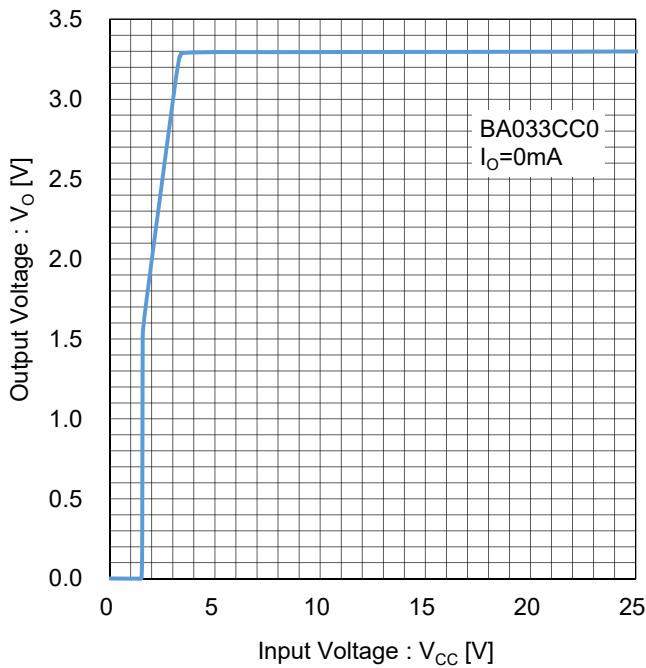

Figure 18. Output Voltage vs Input Voltage
($I_o=0mA$)
Test Circuit C

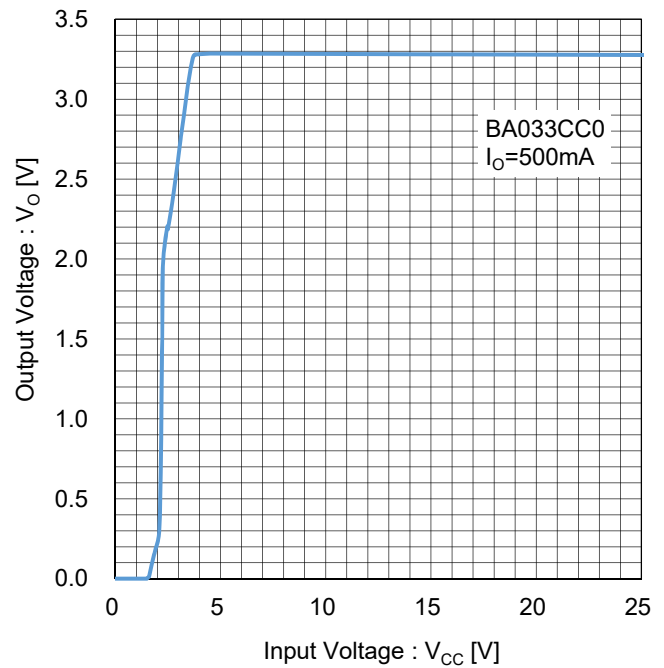

Figure 19. Output Voltage vs Input Voltage
($I_o=500mA$)
Test Circuit C

BA033CC0 ($V_o=3.3V$)

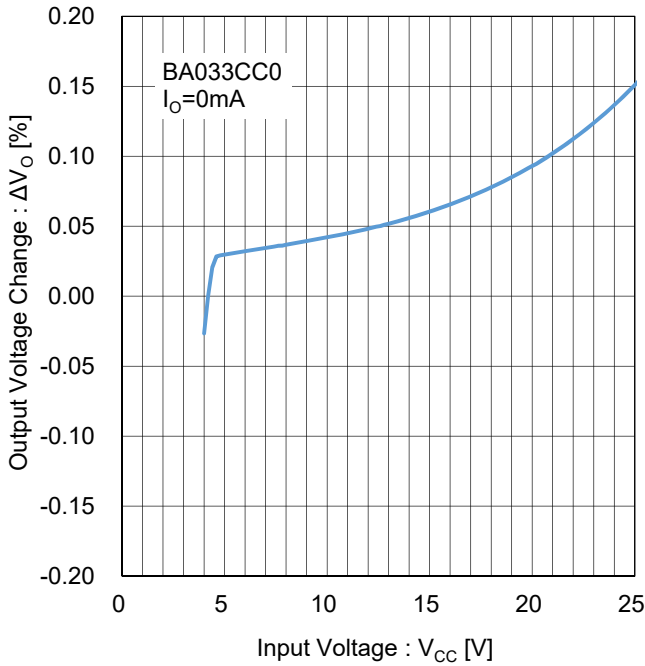

Figure 20. Line Regulation ($I_o=0mA$)
Test Circuit D

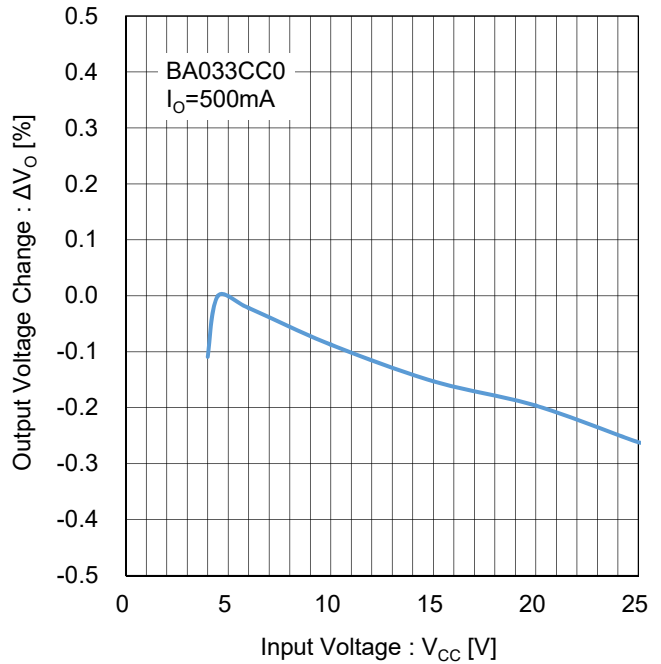

Figure 21. Line Regulation ($I_o=500mA$)
Test Circuit D

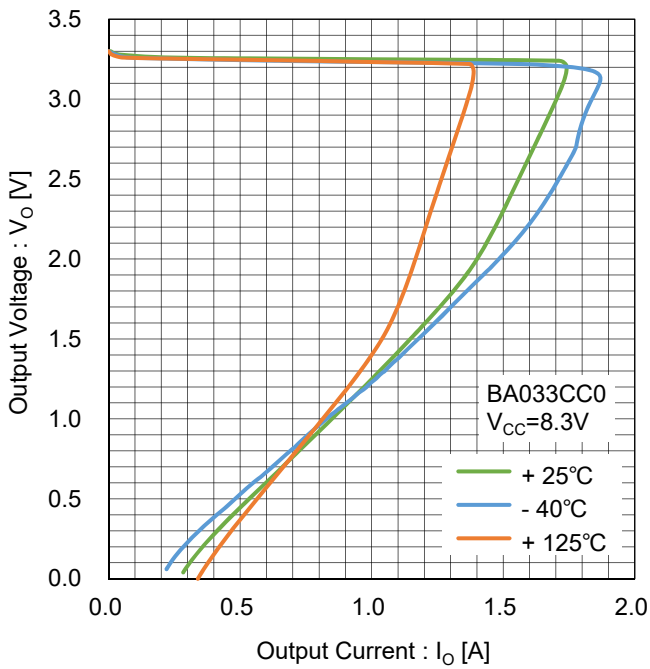

Figure 22. Overcurrent Protection
Test Circuit E

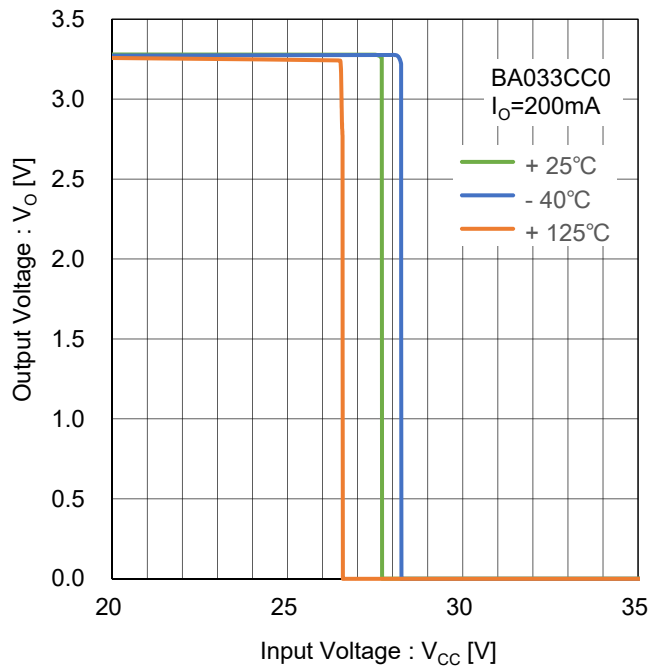

Figure 23. Overvoltage Protection
Test Circuit F

BA033CC0 ($V_o=3.3V$)

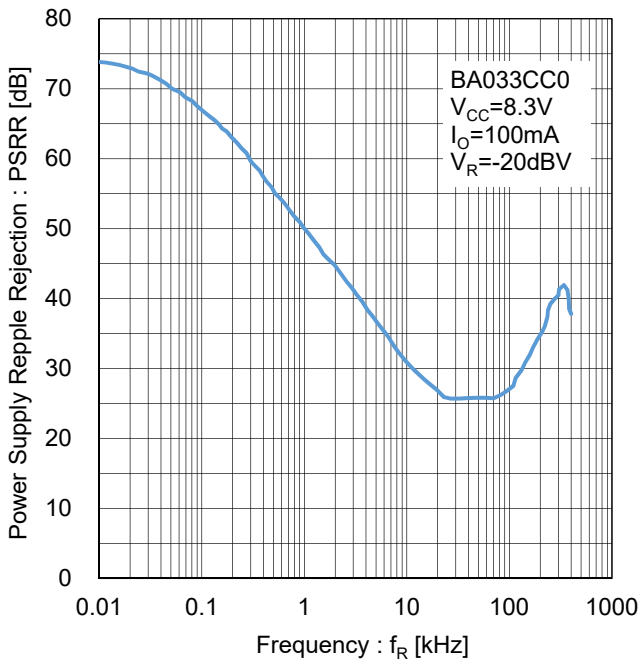

Figure 24. Ripple Rejection
Test Circuit G

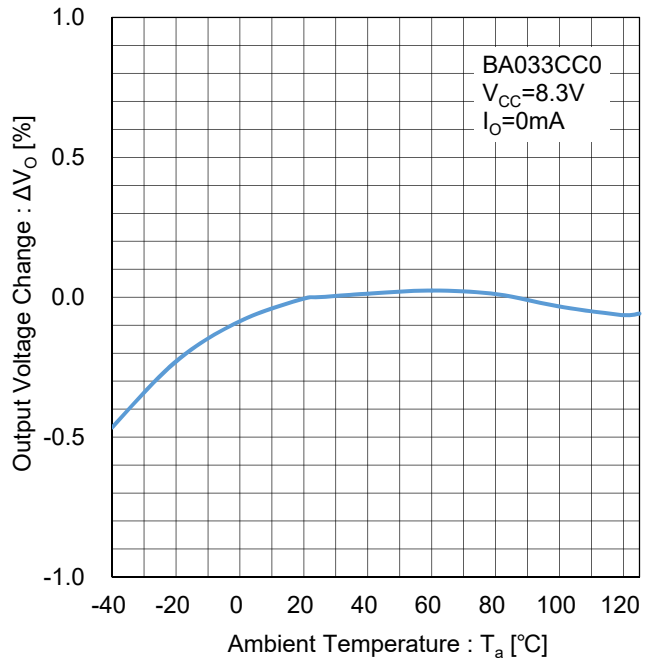

Figure 25. Output Voltage Temperature Stability
Test Circuit H

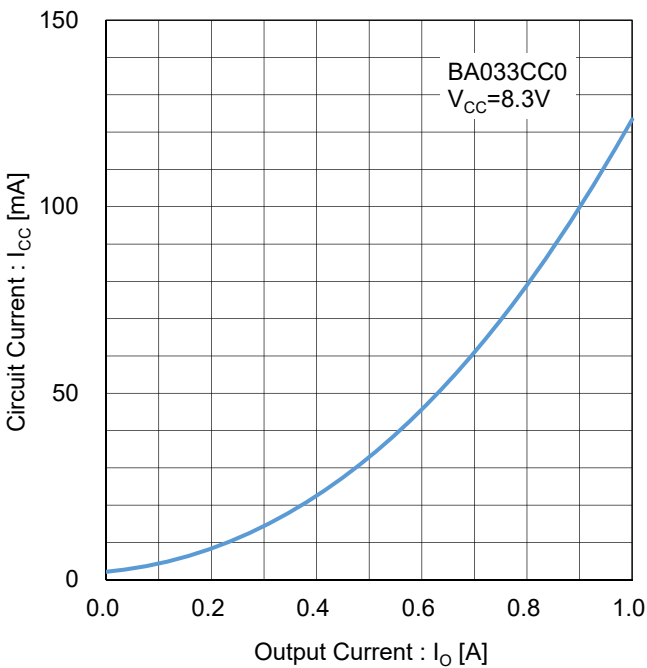

Figure 26. Circuit Current vs Output Current
Test Circuit I

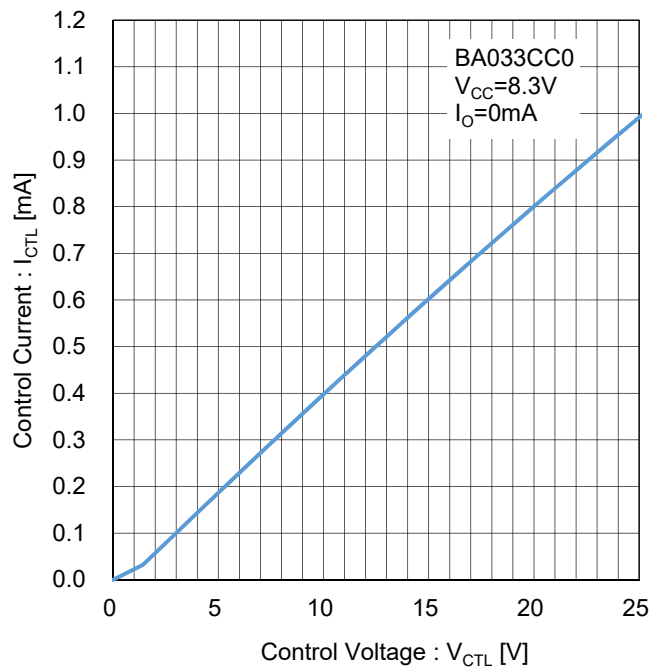

Figure 27. CTL Pin Current
Test Circuit J

BA033CC0 ($V_o=3.3V$)

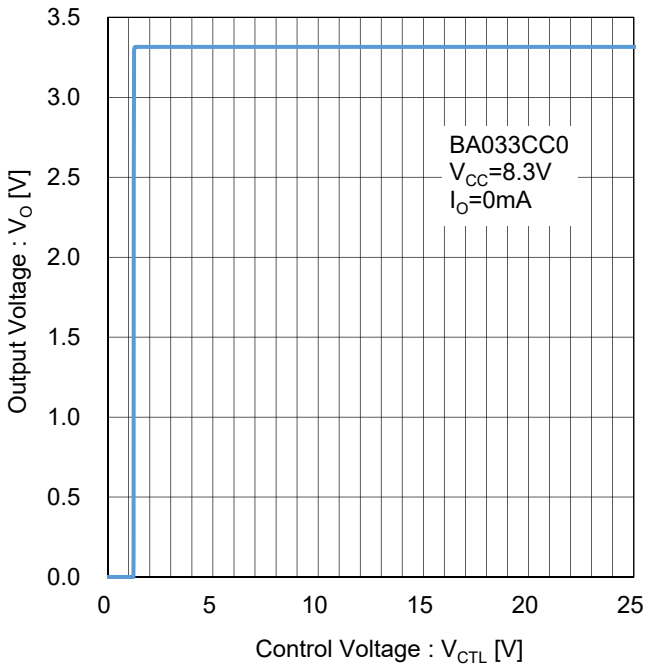

Figure 28. Output Voltage vs CTL Pin Voltage
Test Circuit K

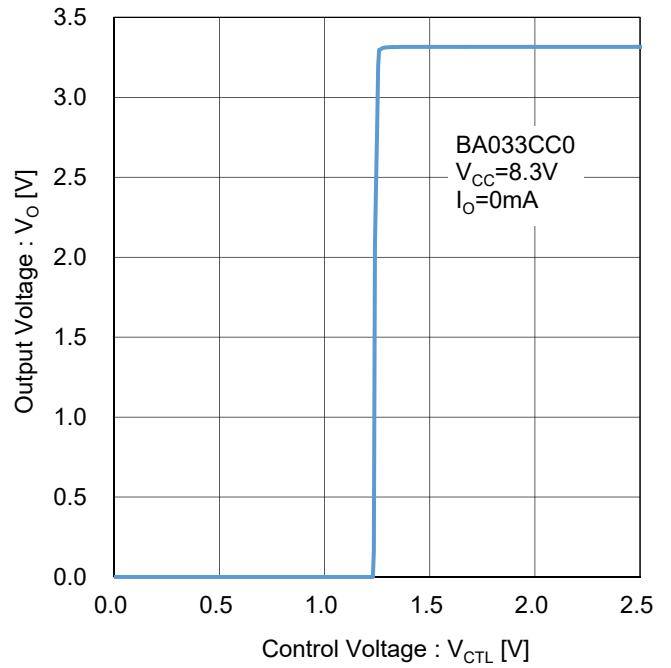

Figure 29. Output Voltage vs CTL Pin Voltage
Test Circuit K

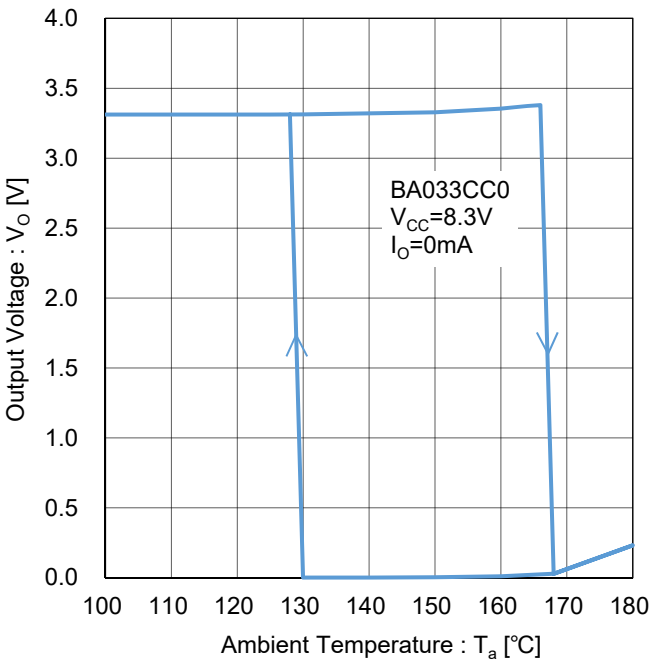

Figure 30. Thermal Shutdown
Test Circuit L

BA05CC0 ($V_o=5.0V$)

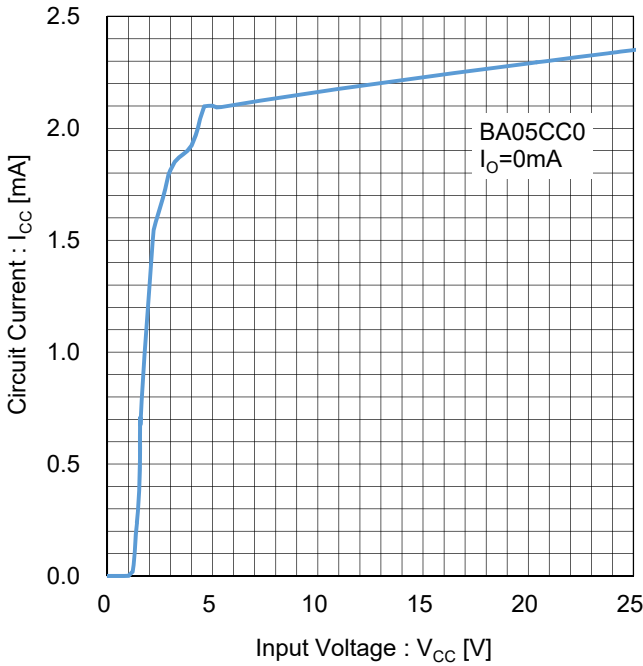

Figure 31. Circuit Current
Test Circuit A

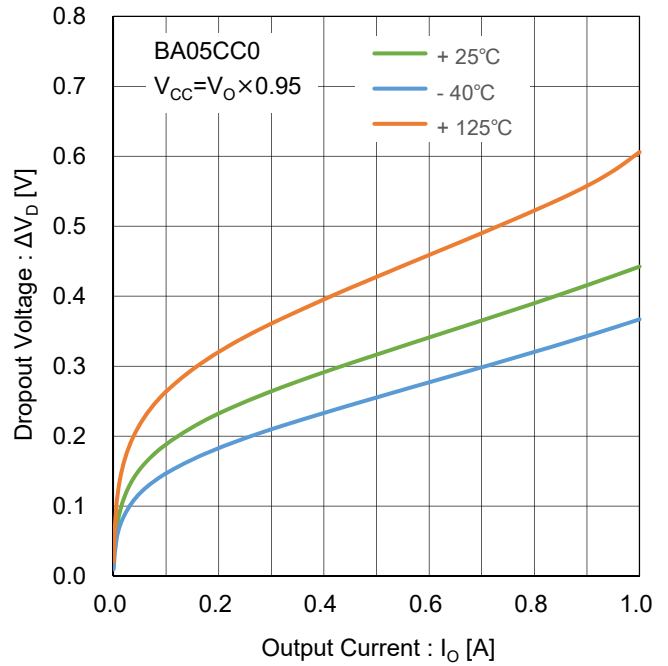

Figure 32. Dropout Voltage vs Output Current
Test Circuit B

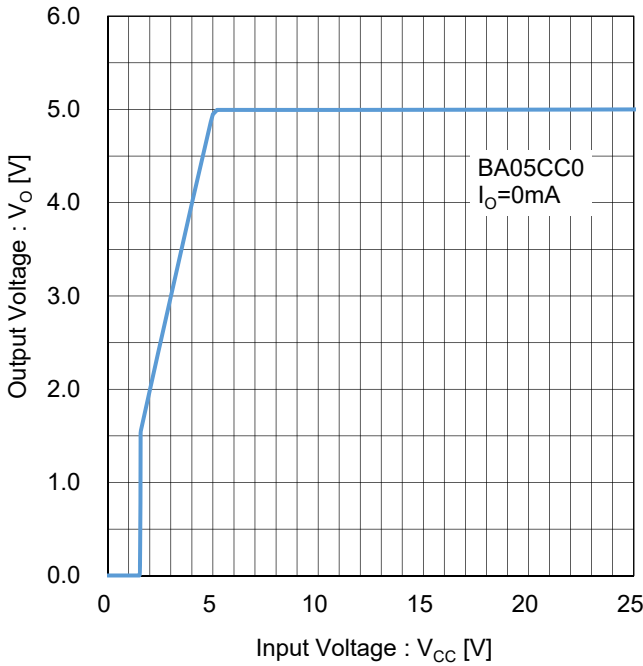

Figure 33. Output Voltage vs Input Voltage
($I_o=0mA$)
Test Circuit C

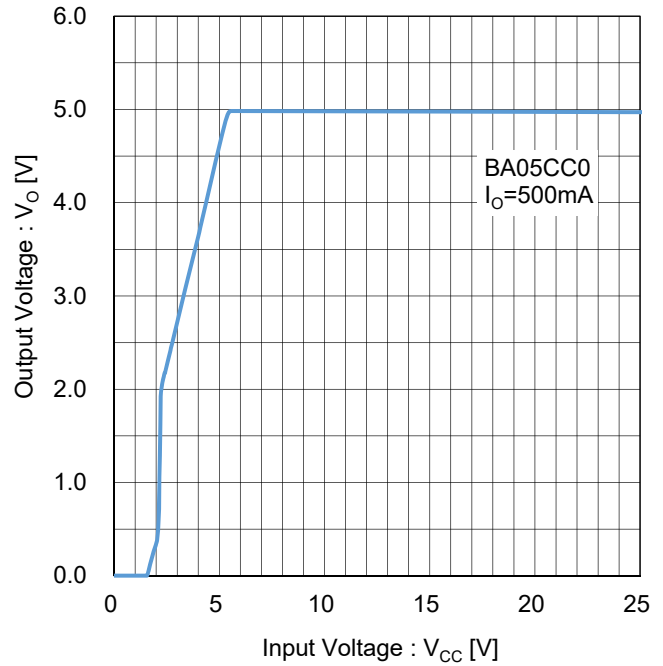

Figure 34. Output Voltage vs Input Voltage
($I_o=500mA$)
Test Circuit C

BA05CC0 (V_O=5.0V)

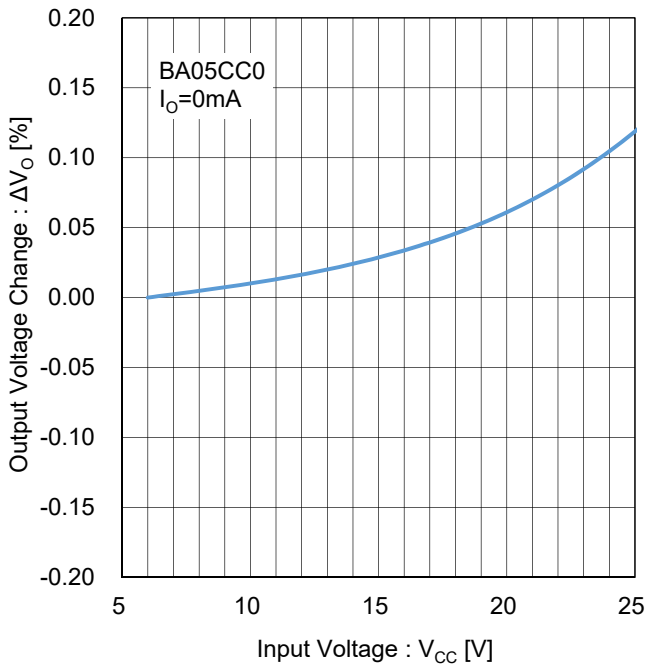

Figure 35. Line Regulation
($I_o=0mA$)
Test Circuit D

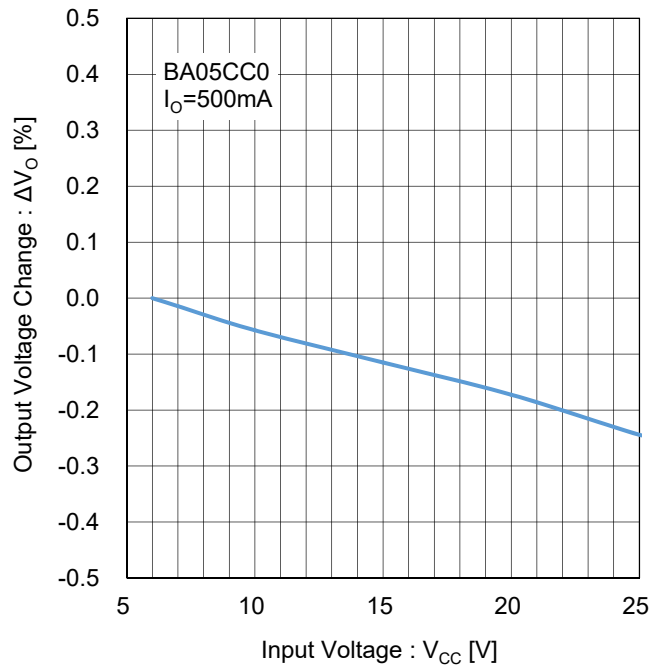

Figure 36. Line Regulation
($I_o=500mA$)
Test Circuit D

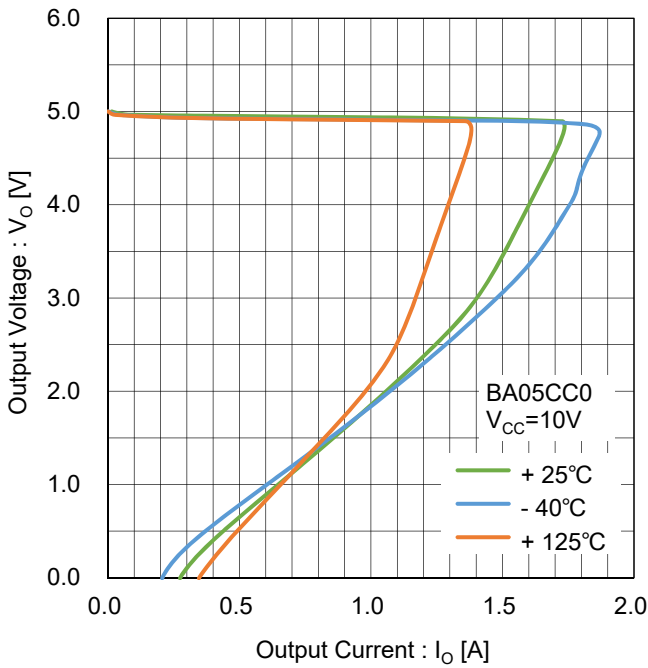

Figure 37. Overcurrent Protection
Test Circuit E

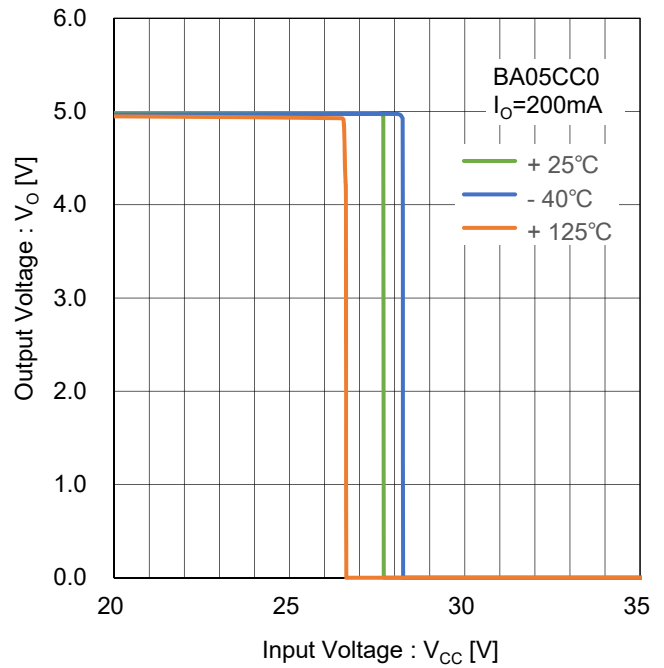

Figure 38. Overvoltage Protection
Test Circuit F

BA05CC0 ($V_o=5.0V$)

Refer to the data of BA033CC0

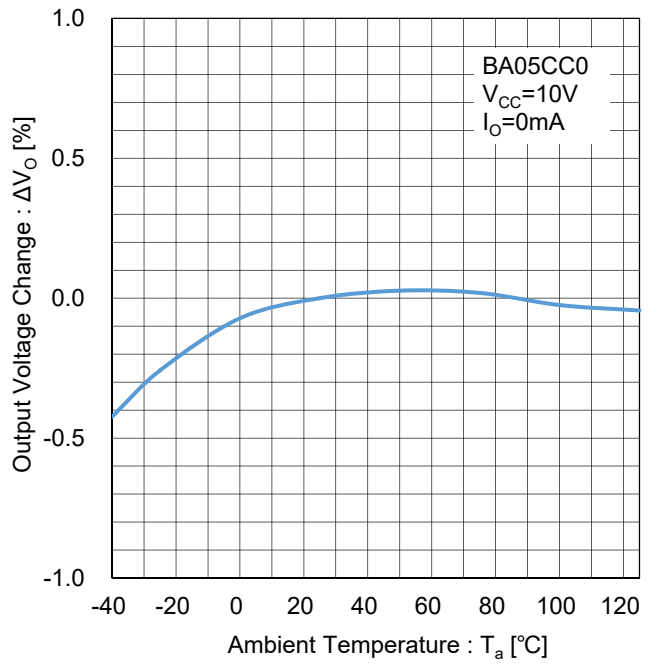

Figure 40. Output Voltage Temperature Stability Test Circuit H

Figure 39. Ripple Rejection Test Circuit G

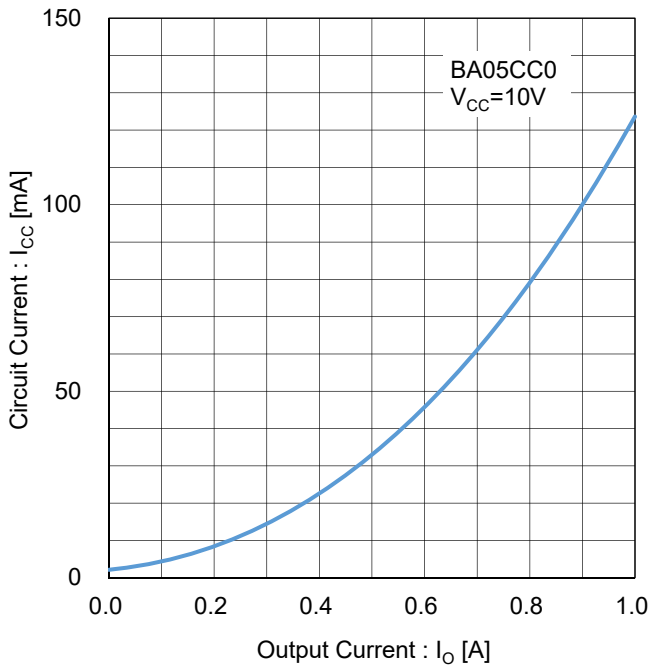

Figure 41. Circuit Current vs Output Current Test Circuit I

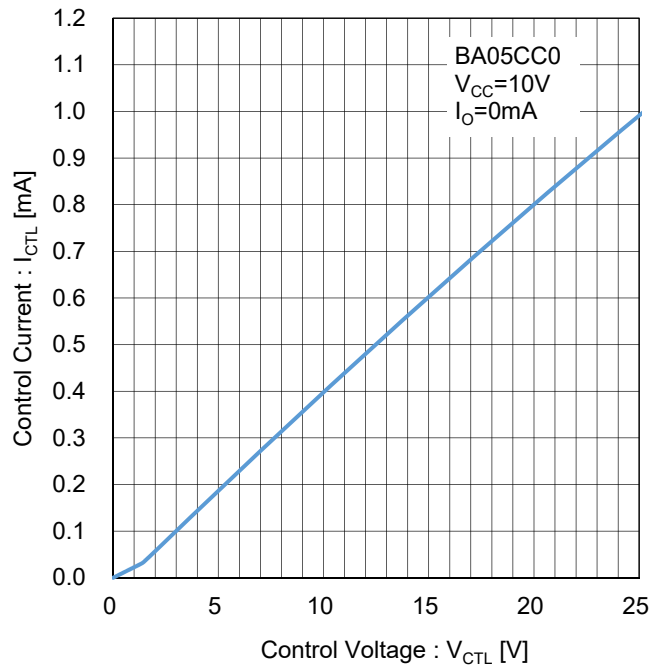

Figure 42. CTL Pin Current Test Circuit J

BA05CC0 ($V_o=5.0V$)

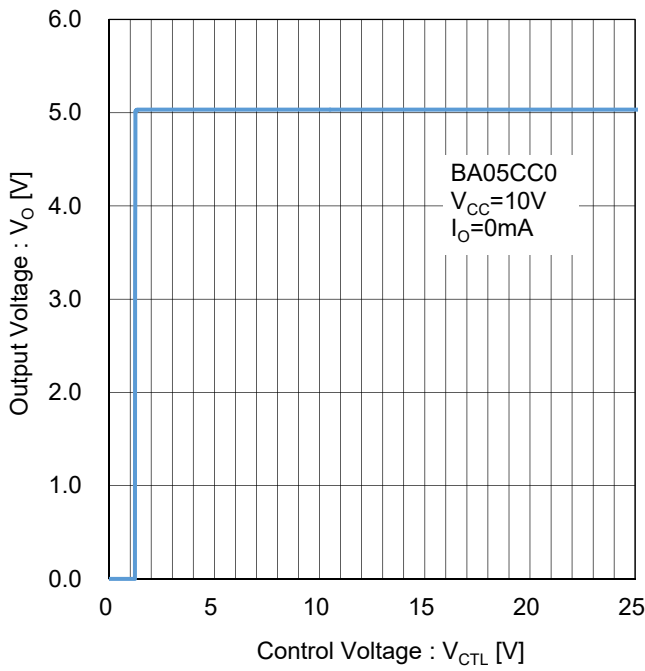

Figure 43. Output Voltage vs CTL Pin Voltage
Test Circuit K

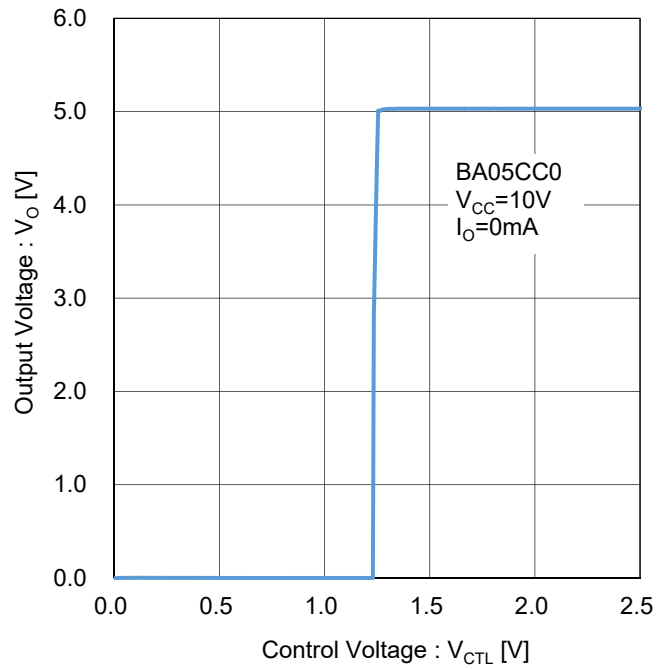

Figure 44. Output Voltage vs CTL Pin Voltage
Test Circuit K

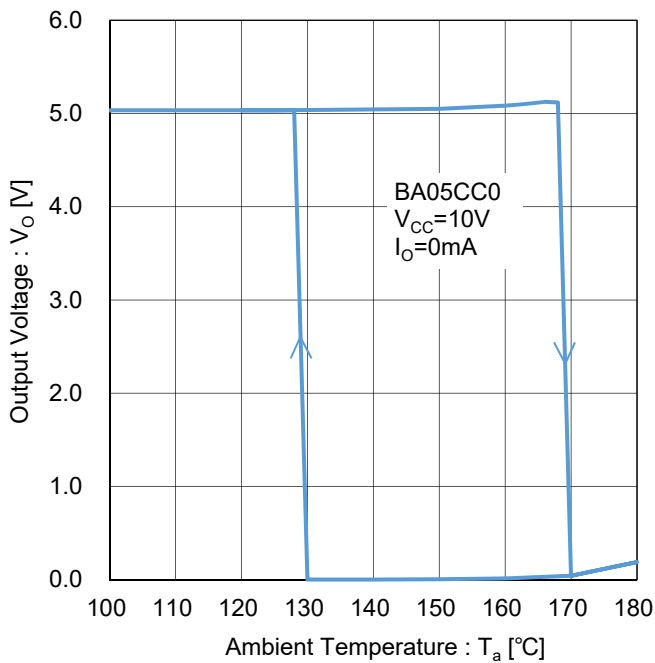

Figure 45. Thermal Shutdown
Test Circuit L

BA06CC0 ($V_o=6.0V$)

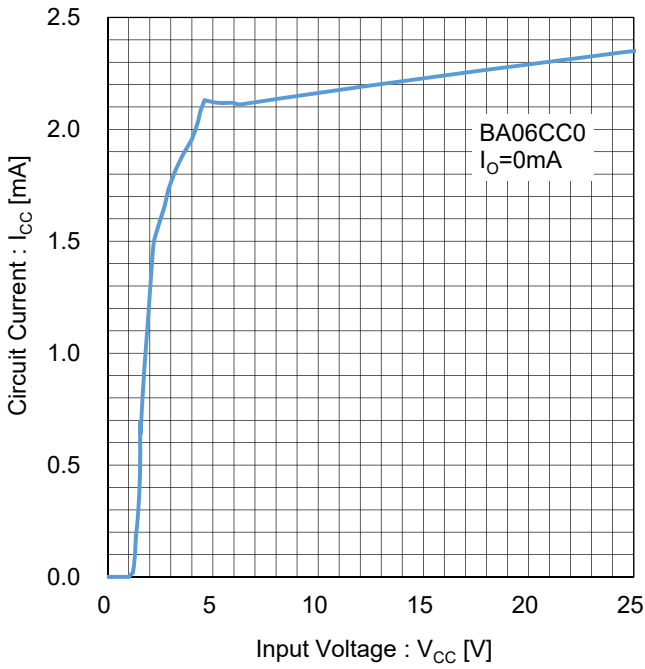

Figure 46. Circuit Current
Test Circuit A

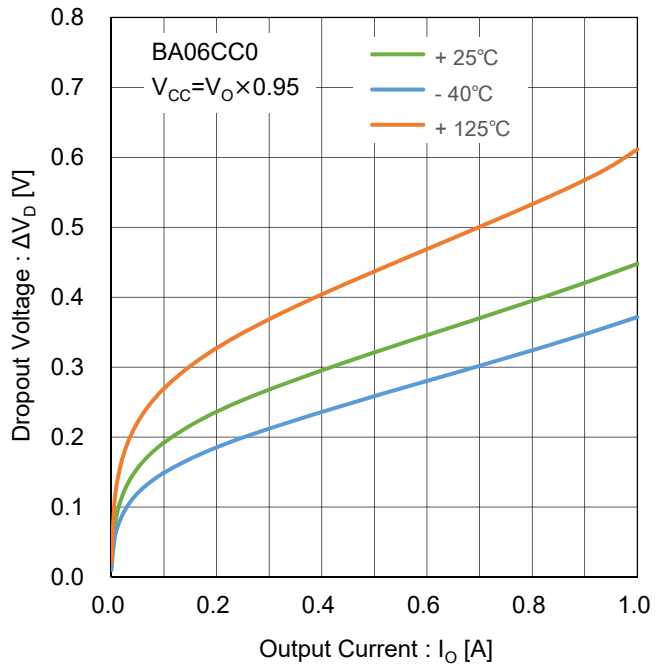

Figure 47. Dropout Voltage vs Output Current
Test Circuit B

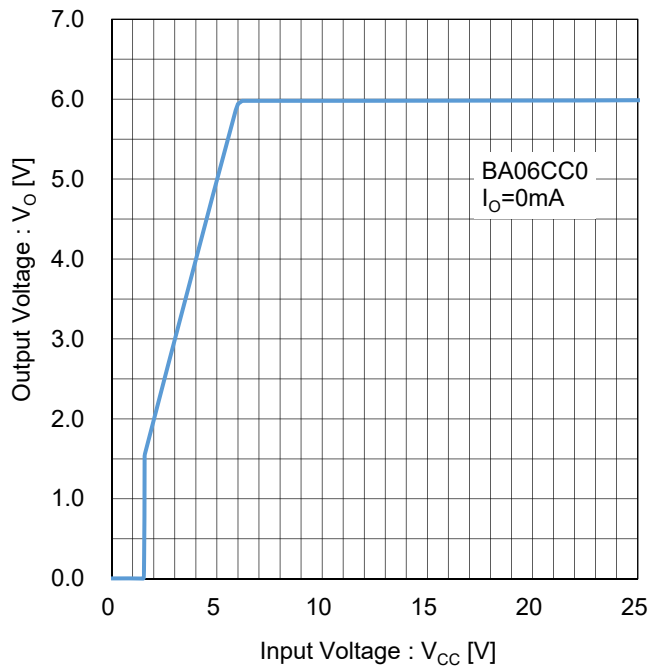

Figure 48. Output Voltage vs Input Voltage
($I_o=0mA$)
Test Circuit C

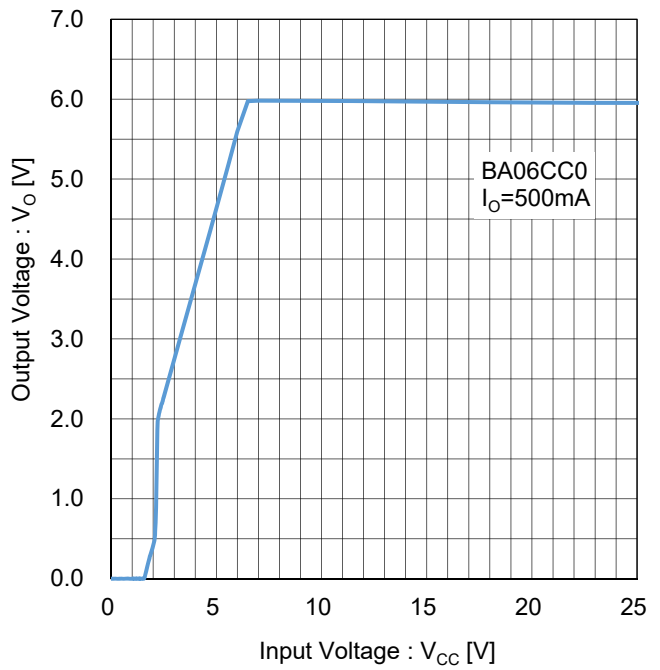

Figure 49. Output Voltage vs Input Voltage
($I_o=500mA$)
Test Circuit C

BA06CC0 (V_O=6.0V)

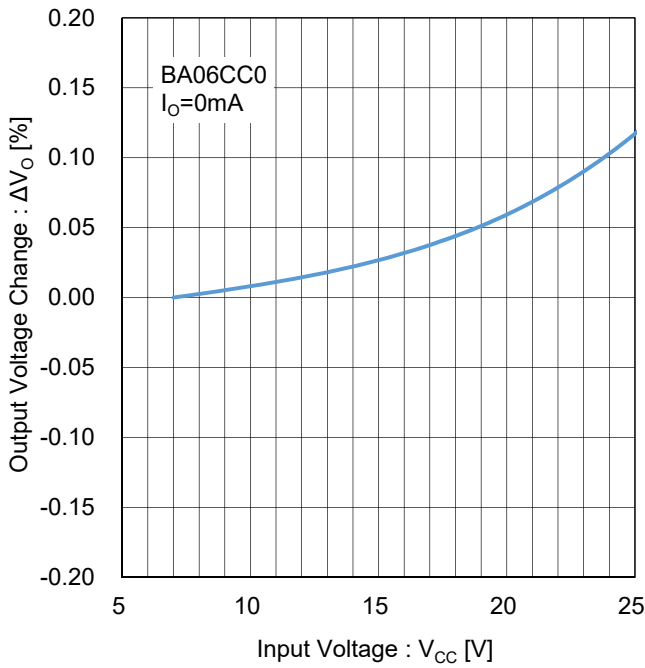

Figure 50. Line Regulation
(I_o=0mA)
Test Circuit D

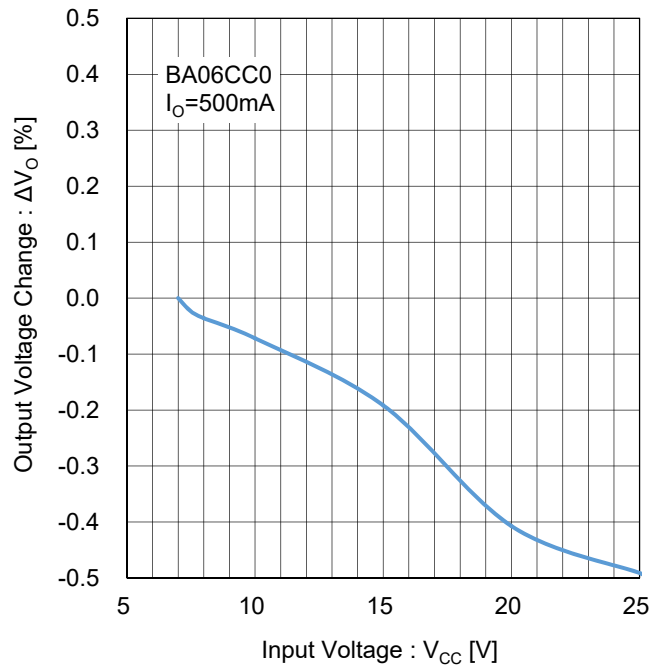

Figure 51. Line Regulation
(I_o=500mA)
Test Circuit D

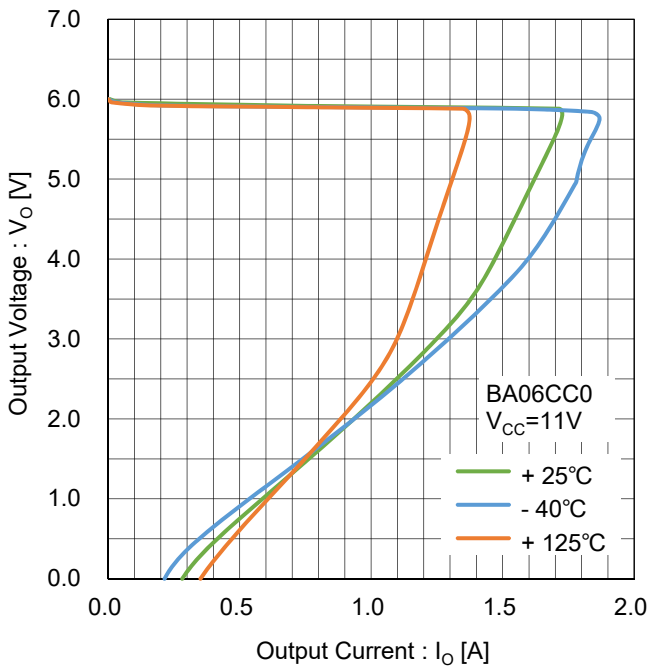

Figure 52. Overcurrent Protection
Test Circuit E

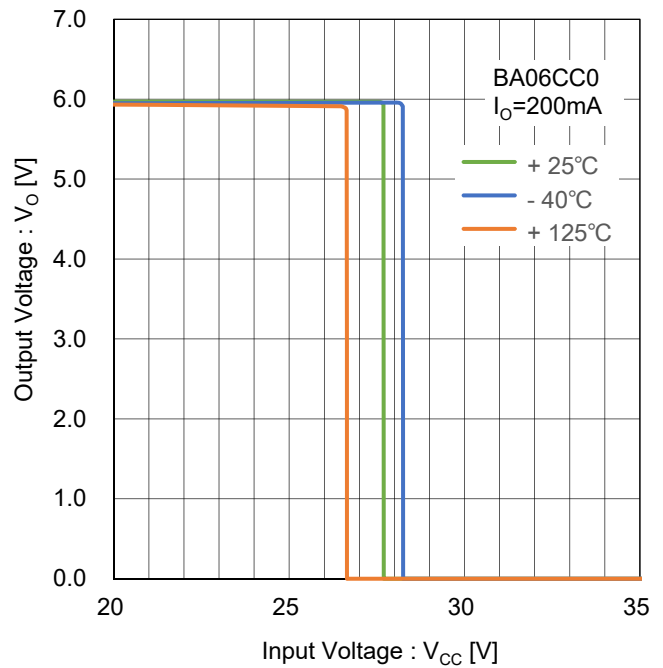

Figure 53. Overvoltage Protection
Test Circuit F

BA06CC0 ($V_O=6.0V$)

Refer to the data of BAJ0CC0

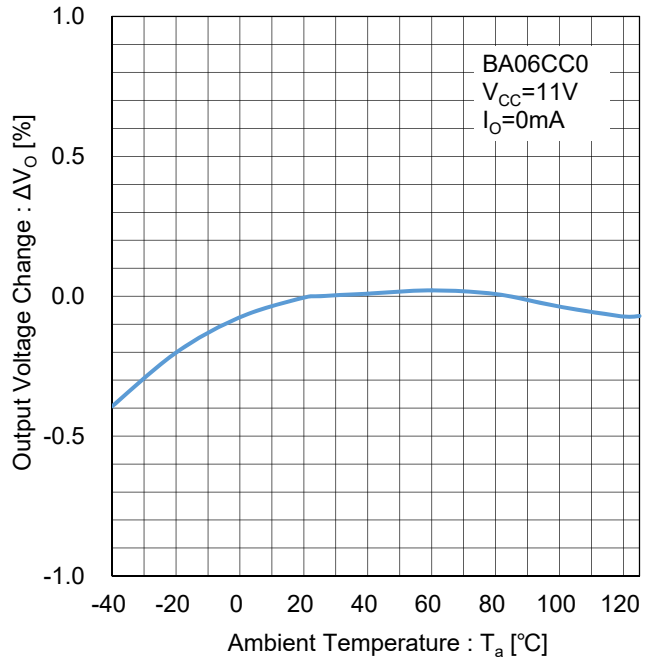

Figure 55. Output Voltage Temperature Stability Test Circuit H

Figure 54. Ripple Rejection Test Circuit G

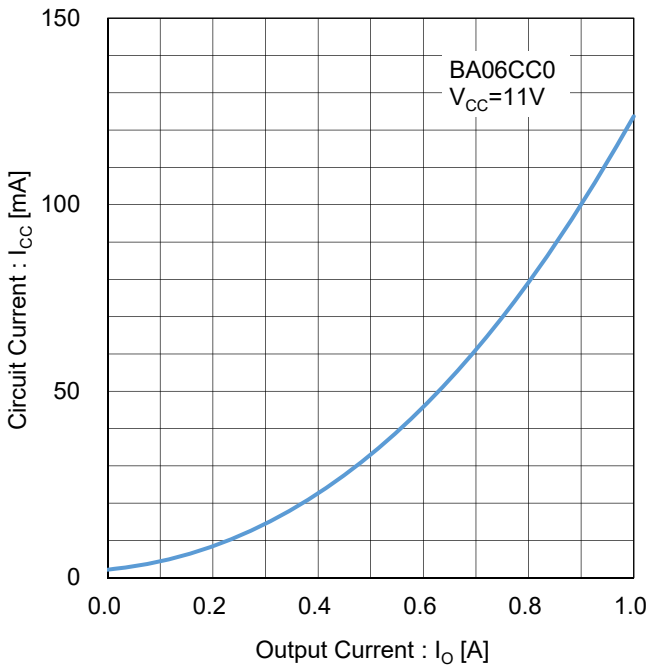

Figure 56. Circuit Current vs Output Current Test Circuit I

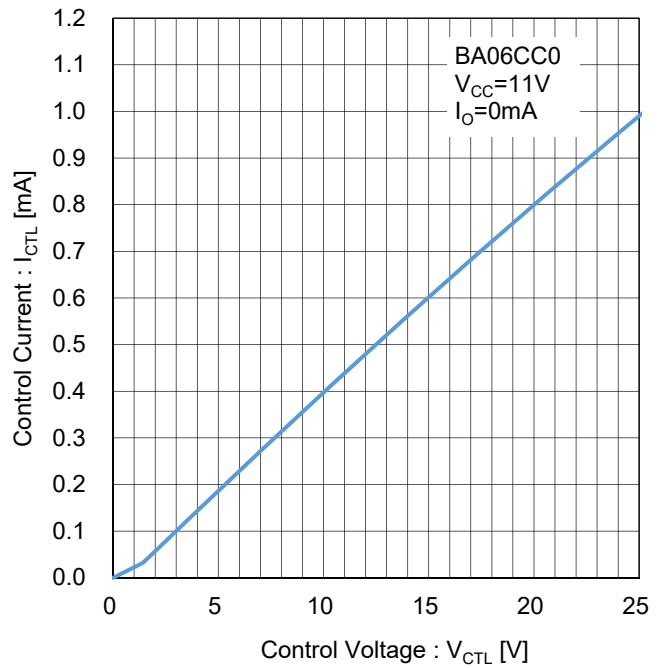

Figure 57. CTL Pin Current Test Circuit J

BA06CC0 ($V_O=6.0V$)

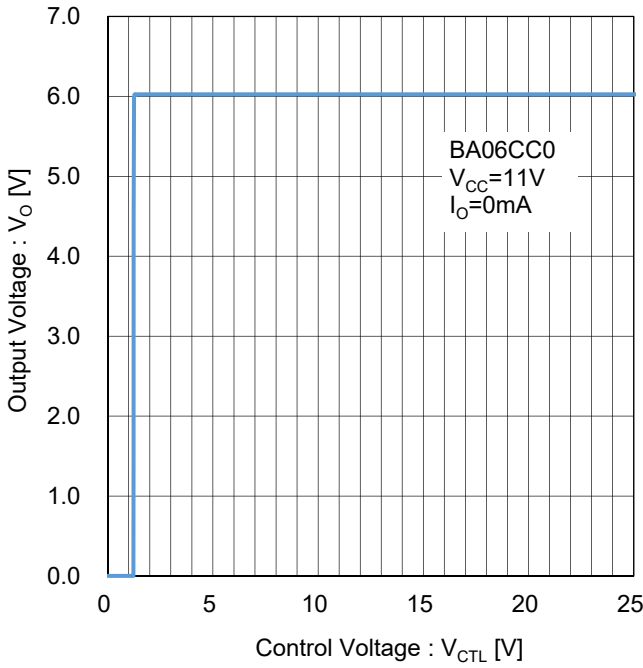

Figure 58. Output Voltage vs CTL Pin Voltage
Test Circuit K

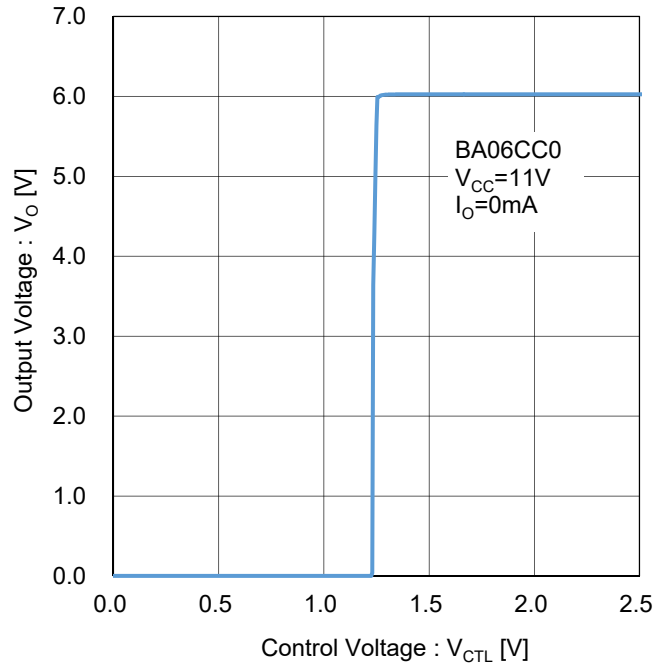

Figure 59. Output Voltage vs CTL Pin Voltage
Test Circuit K

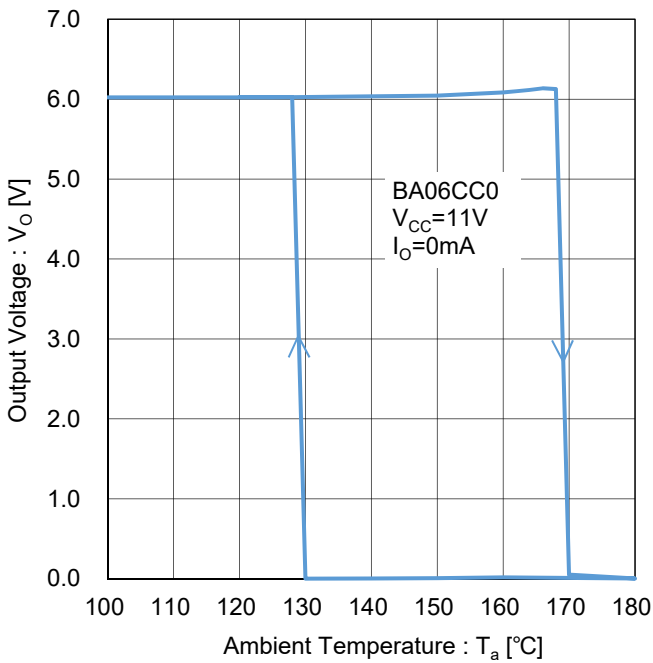

Figure 60. Thermal Shutdown
Test Circuit L

BA07CC0 ($V_o=7.0V$)

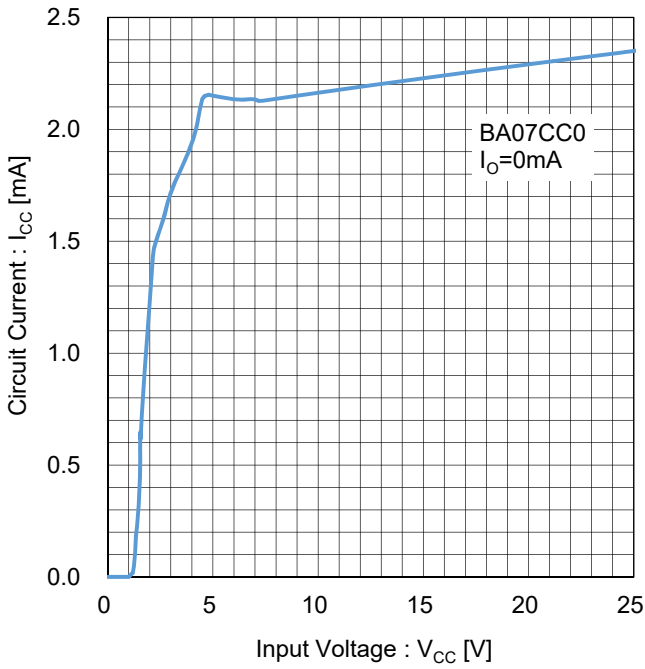

Figure 61. Circuit Current
Test Circuit A

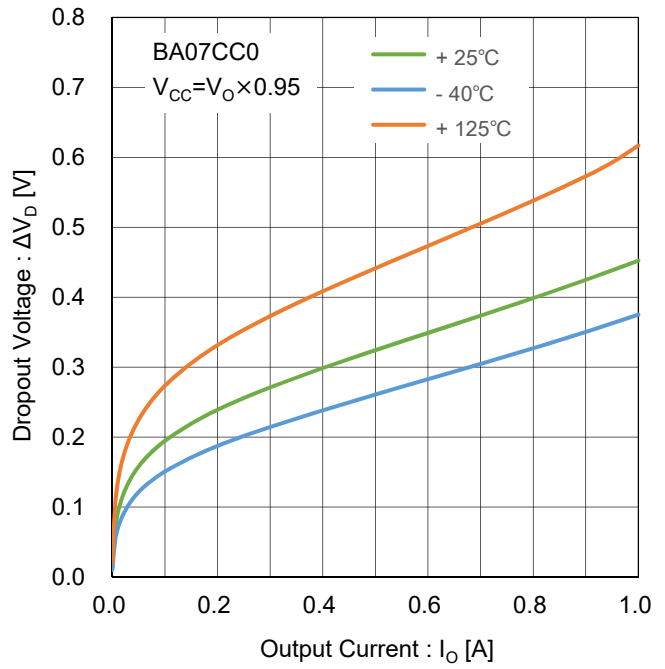

Figure 62. Dropout Voltage vs Output Current
Test Circuit B

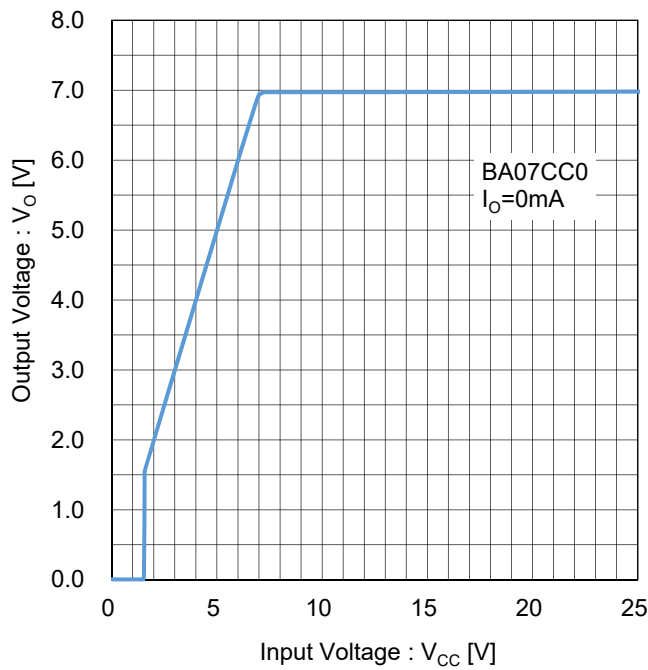

Figure 63. Output Voltage vs Input Voltage
($I_o=0mA$)
Test Circuit C

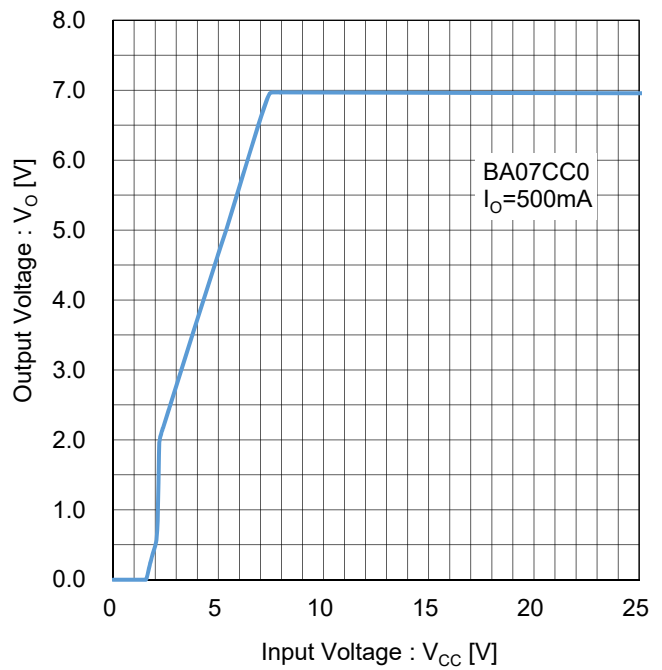

Figure 64. Output Voltage vs Input Voltage
($I_o=500mA$)
Test Circuit C

BA07CC0 (V_O=7.0V)

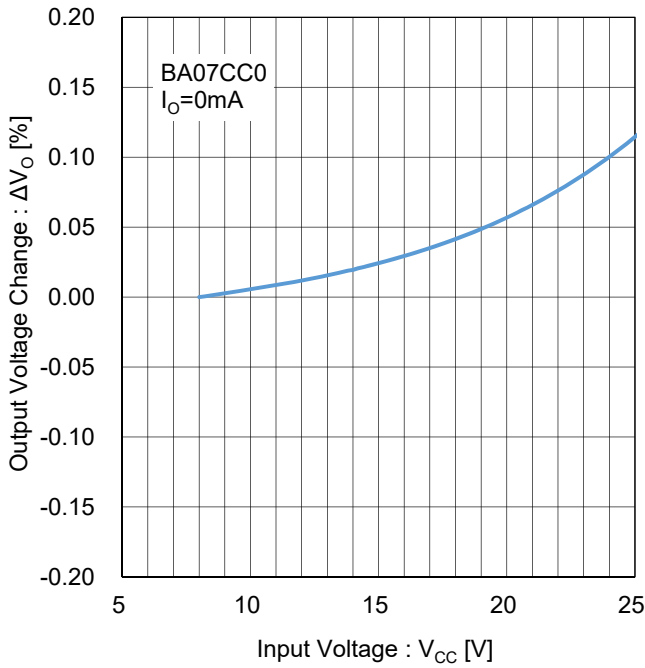

Figure 65. Line Regulation
(I_o=0mA)
Test Circuit D

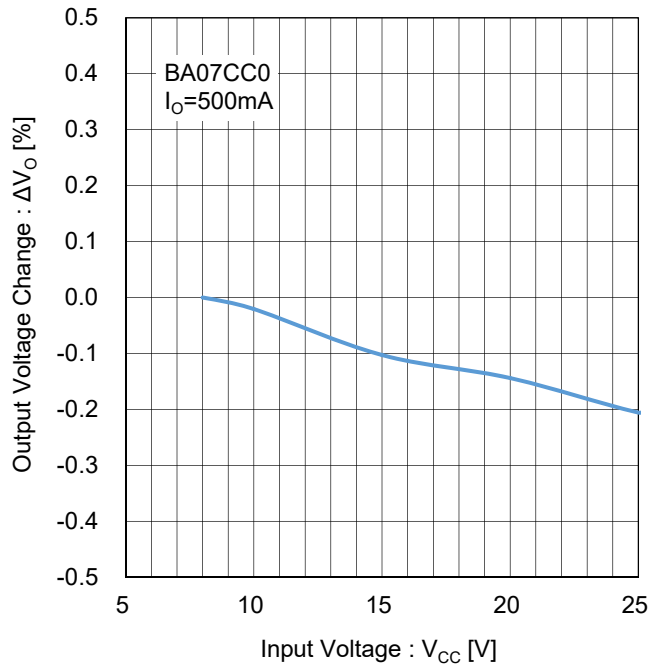

Figure 66. Line Regulation
(I_o=500mA)
Test Circuit D

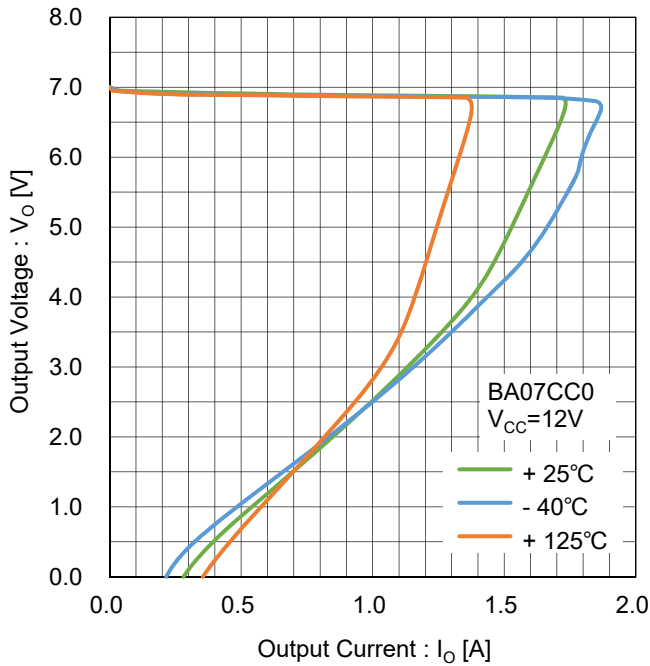

Figure 67. Overcurrent Protection
Test Circuit E

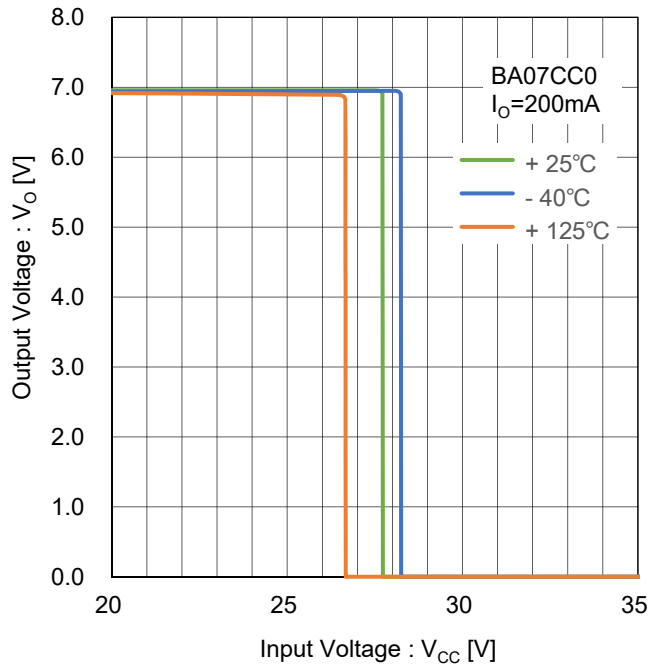

Figure 68. Overvoltage Protection
Test Circuit F

BA07CC0 ($V_o=7.0V$)

Refer to the data of BAJ0CC0

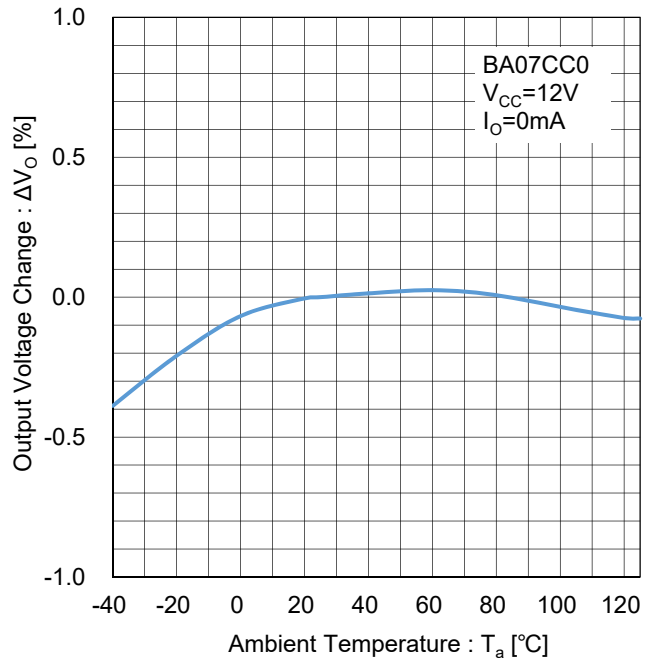

Figure 70. Output Voltage Temperature Stability Test Circuit H

Figure 69. Ripple Rejection Test Circuit G

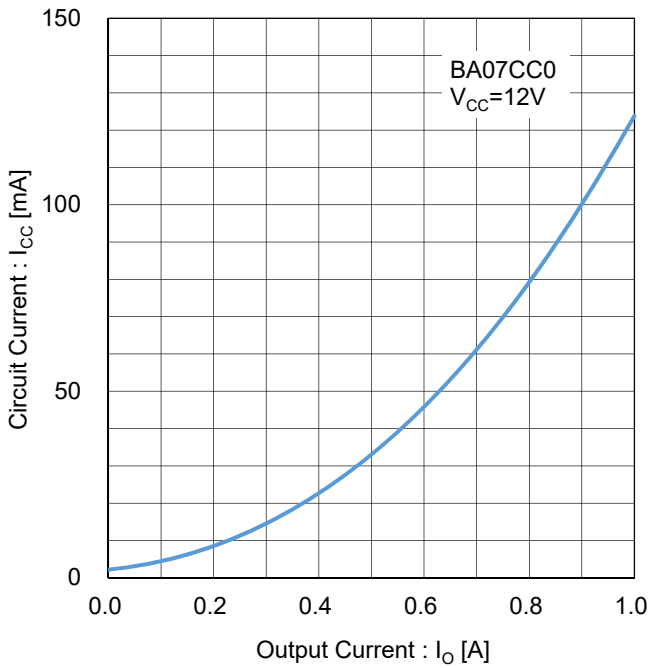

Figure 71. Circuit Current vs Output Current Test Circuit I

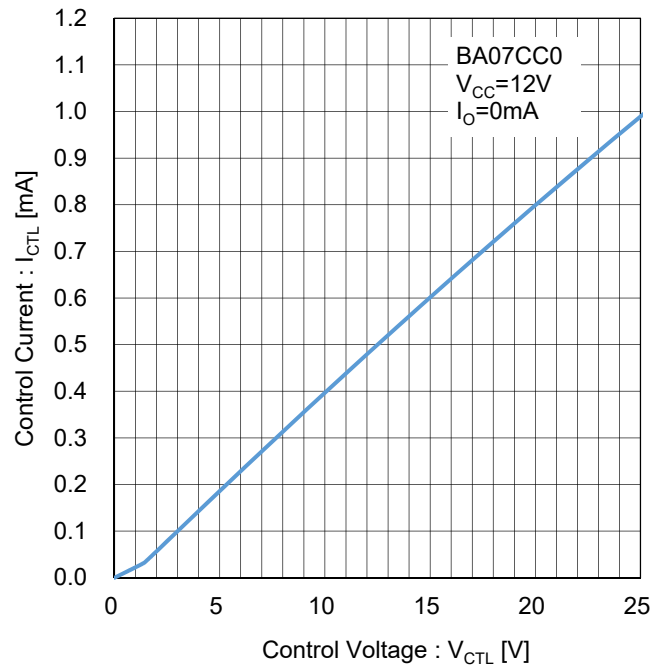

Figure 72. CTL Pin Current Test Circuit J

BA07CC0 ($V_o=7.0V$)

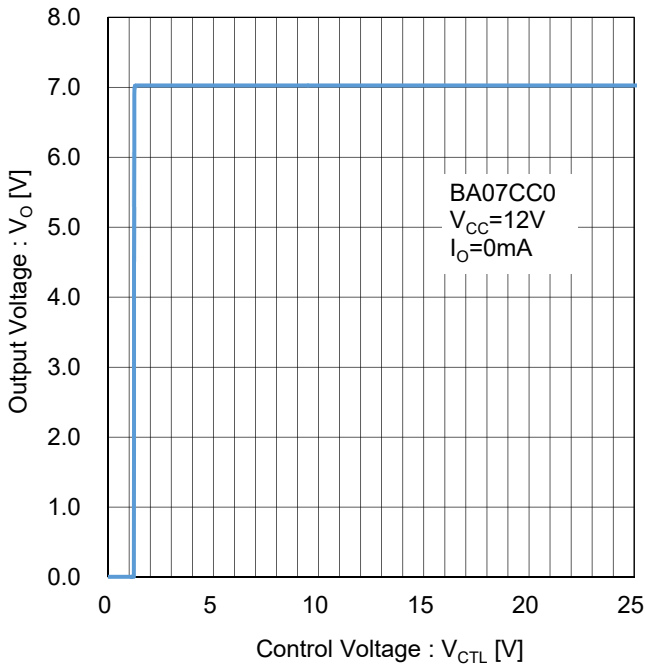

Figure 73. Output Voltage vs CTL Pin Voltage
Test Circuit K

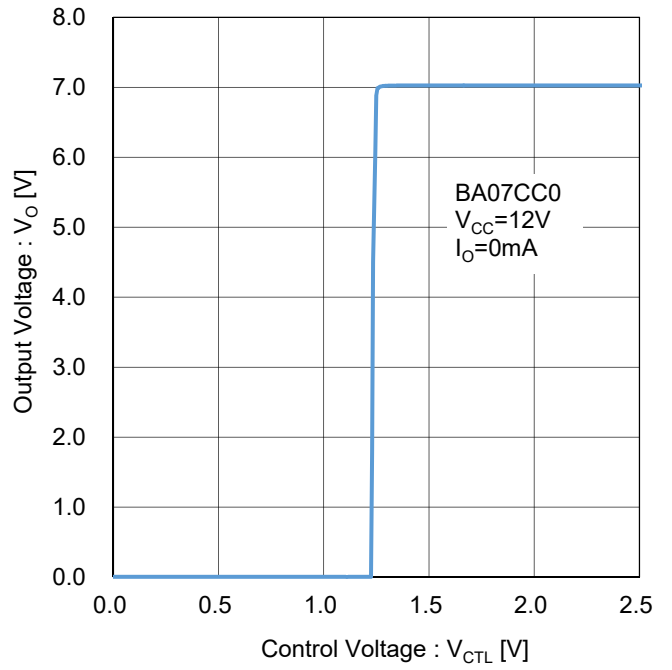

Figure 74. Output Voltage vs CTL Pin Voltage
Test Circuit K

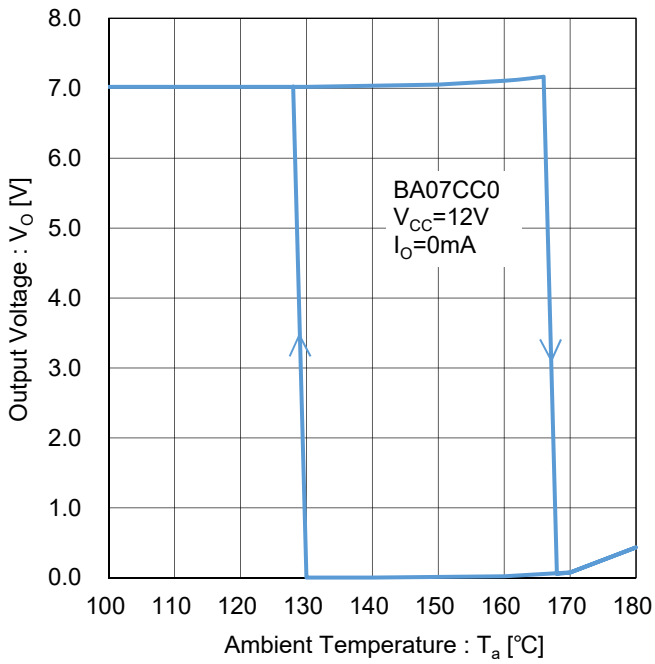

Figure 75. Thermal Shutdown
Test Circuit L

BA08CC0 ($V_o=8.0V$)

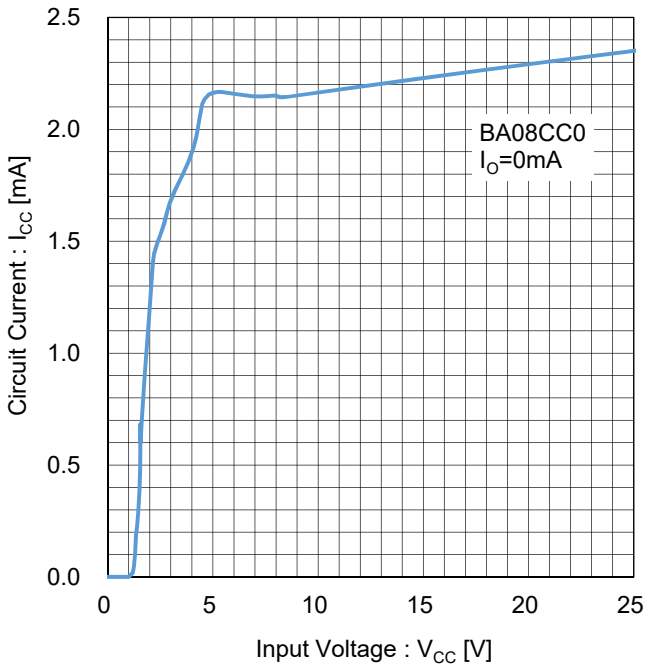

Figure 76. Circuit Current
Test Circuit A

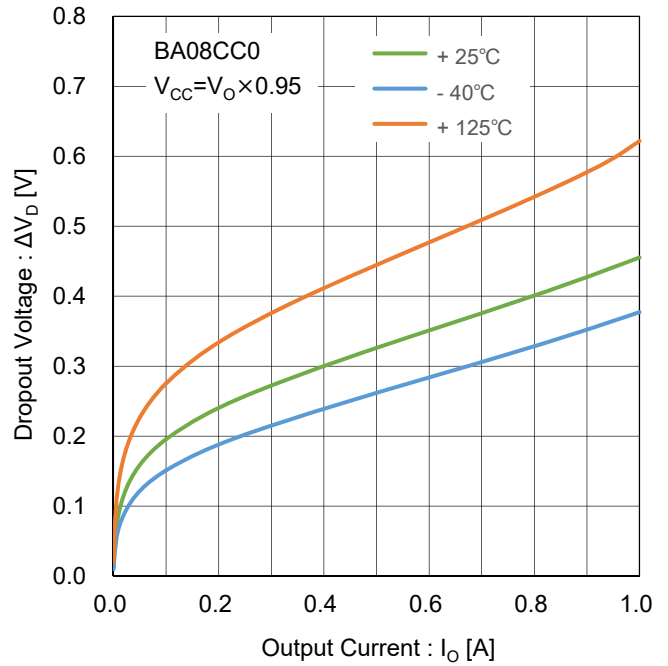

Figure 77. Dropout Voltage vs Output Current
Test Circuit B

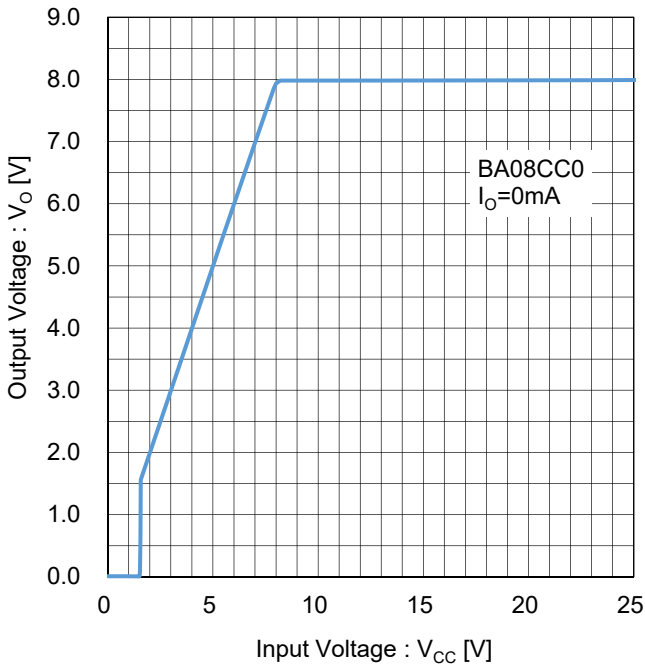

Figure 78. Output Voltage vs Input Voltage
($I_o=0mA$)
Test Circuit C

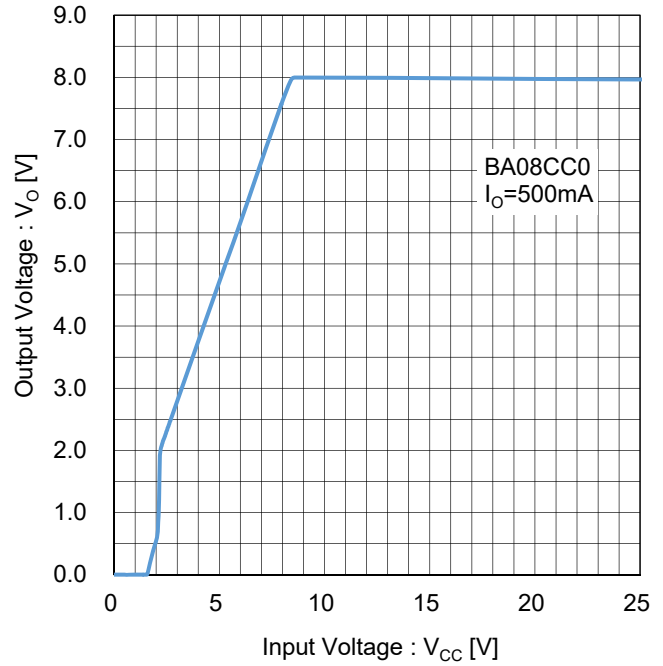

Figure 79. Output Voltage vs Input Voltage
($I_o=500mA$)
Test Circuit C

BA08CC0 (V_O=8.0V)

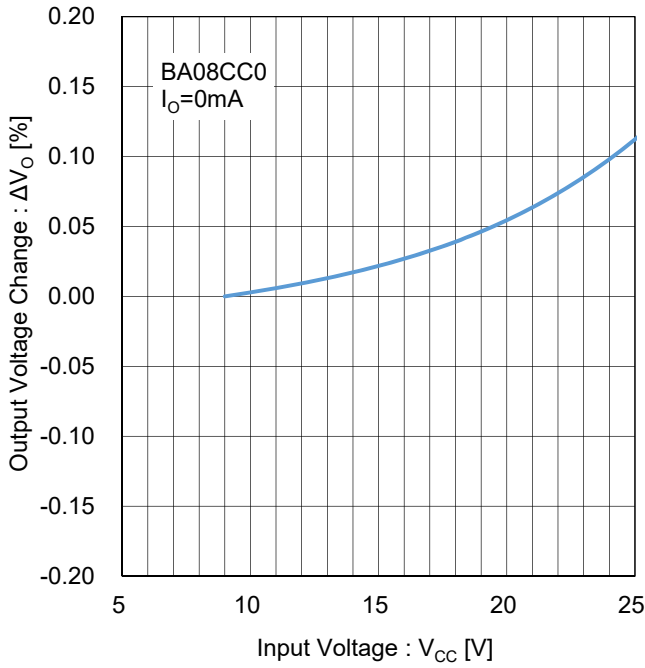

Figure 80. Line Regulation
(I_o=0mA)
Test Circuit D

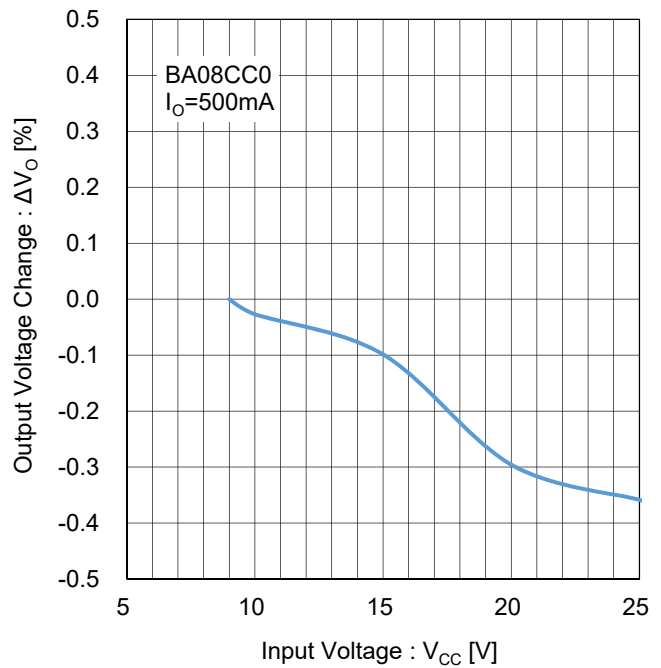

Figure 81. Line Regulation
(I_o=500mA)
Test Circuit D

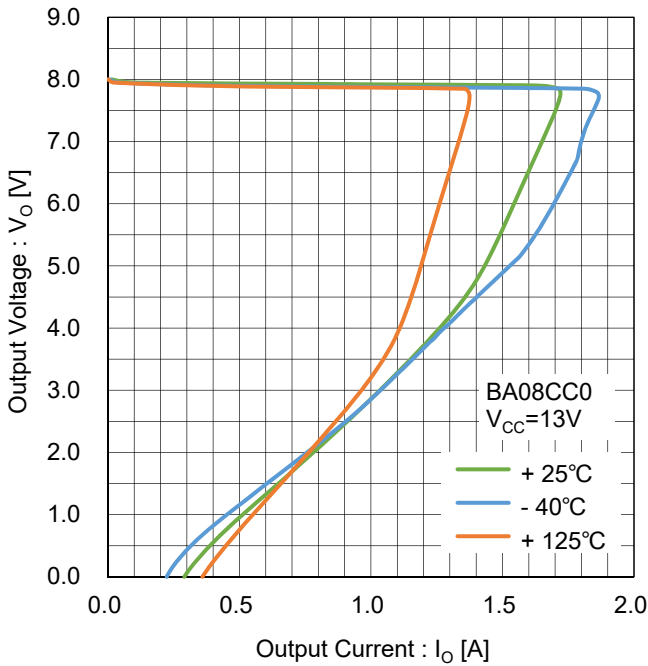

Figure 82. Overcurrent Protection
Test Circuit E

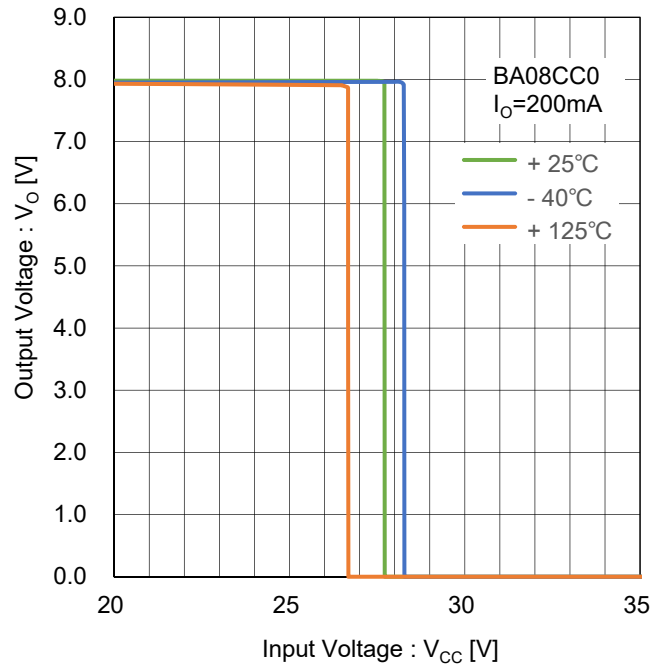

Figure 83. Overvoltage Protection
Test Circuit F

BA08CC0 ($V_O=8.0V$)

Refer to the data of BAJ0CC0

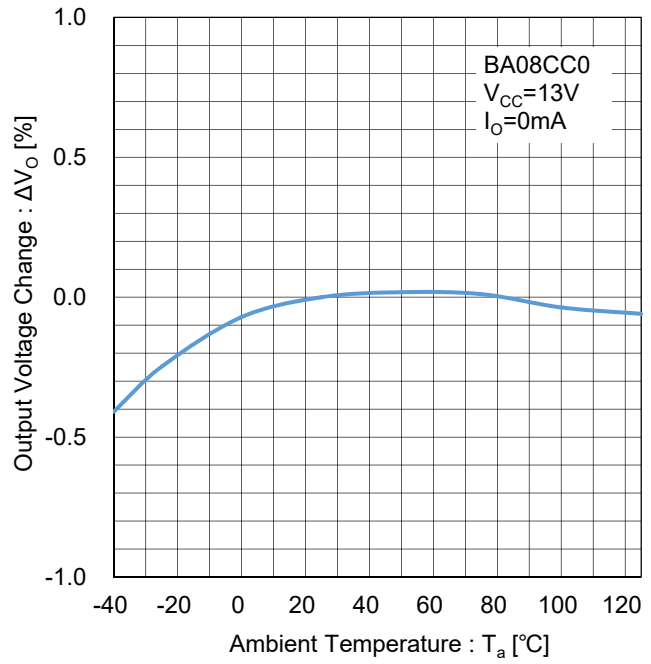

Figure 85. Output Voltage Temperature Stability Test Circuit H

Figure 84. Ripple Rejection Test Circuit G

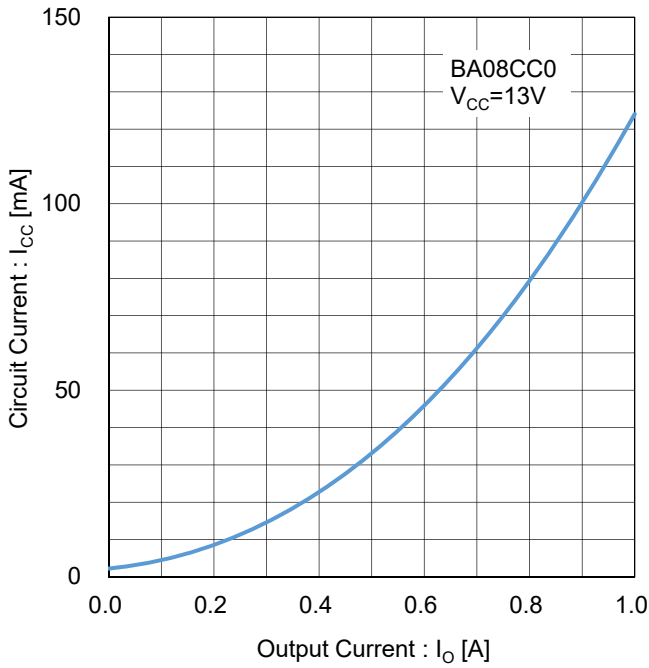

Figure 86. Circuit Current vs Output Current Test Circuit I

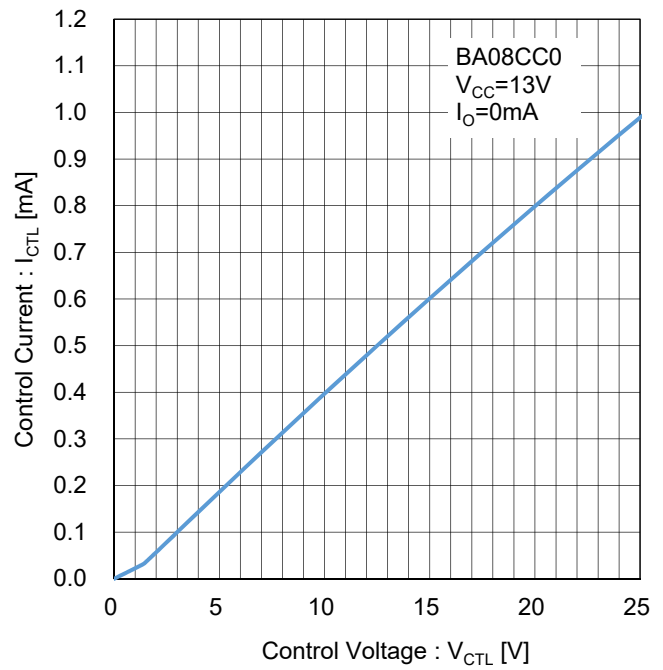

Figure 87. CTL Pin Current Test Circuit J

BA08CC0 ($V_o=8.0V$)

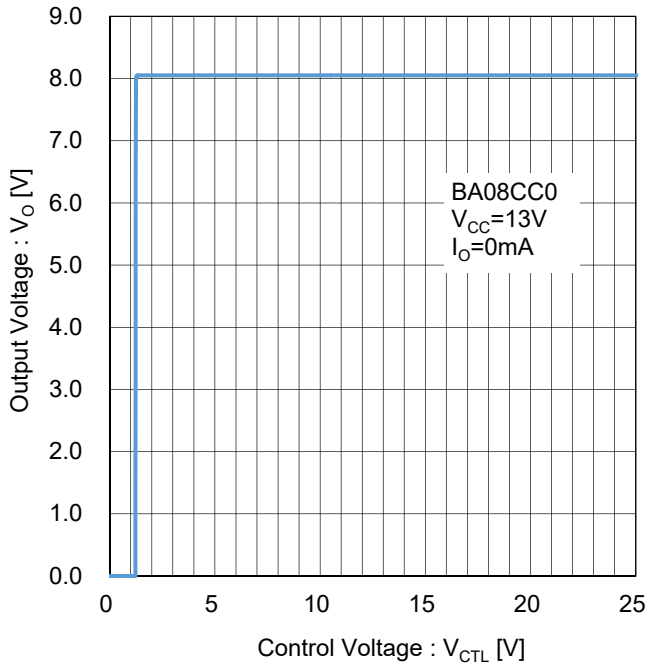

Figure 88. Output Voltage vs CTL Pin Voltage
 Test Circuit K

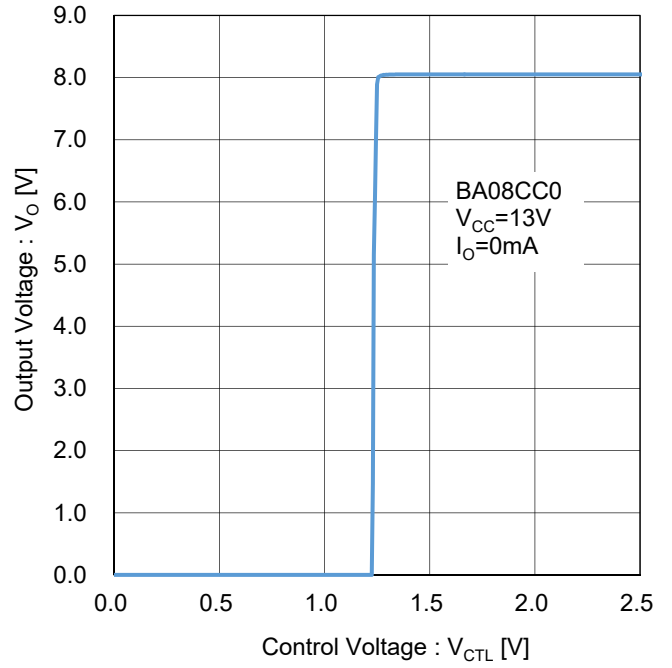

Figure 89. Output Voltage vs CTL Pin Voltage
 Test Circuit K

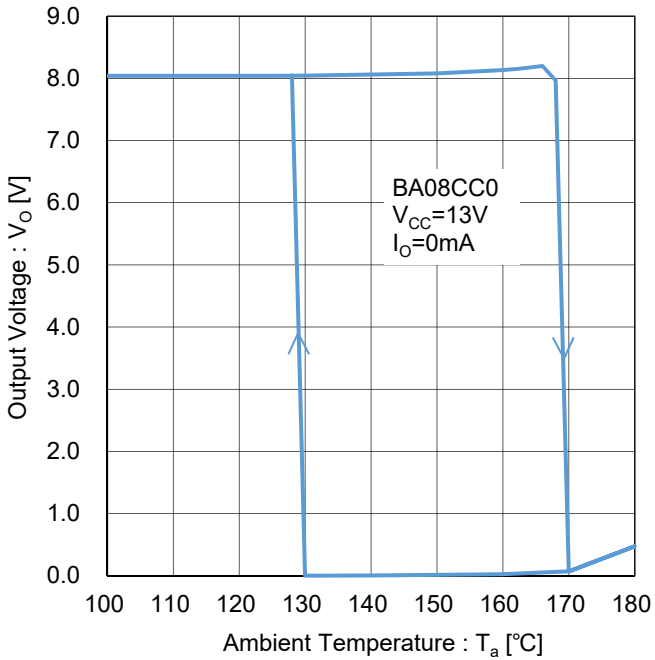

Figure 90. Thermal Shutdown
 Test Circuit L

BA09CC0 ($V_o=9.0V$)

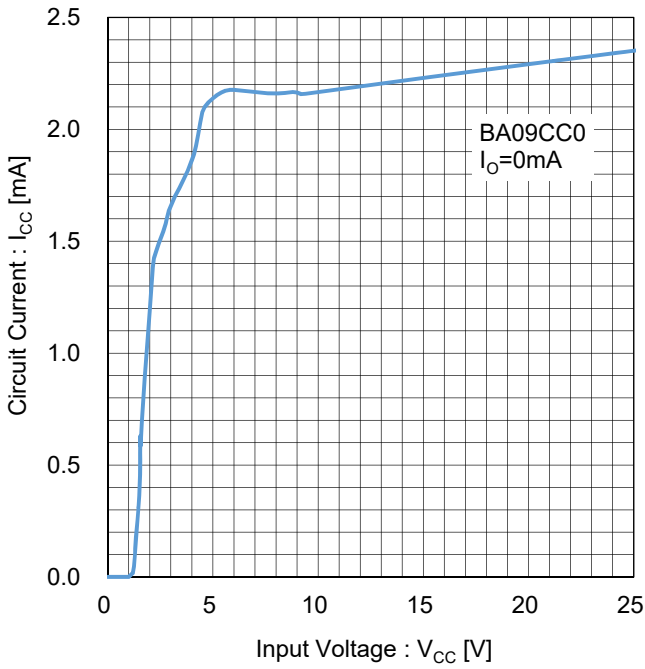

Figure 91. Circuit Current
Test Circuit A

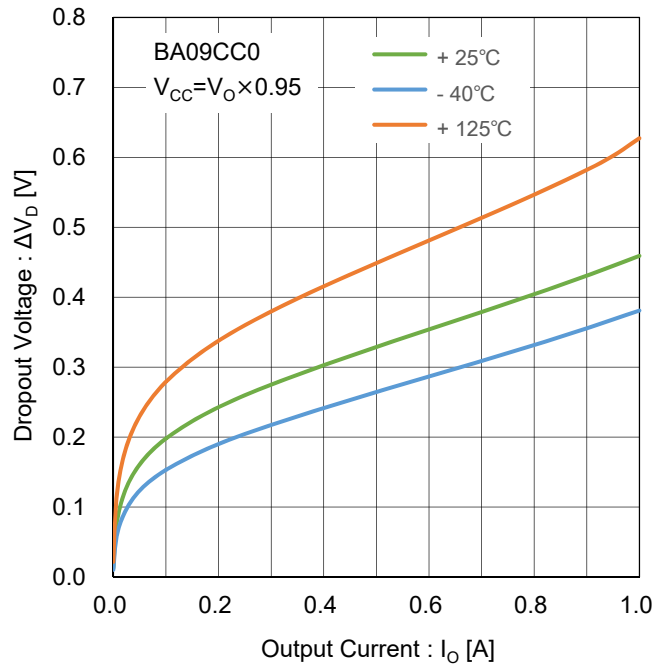

Figure 92. Dropout Voltage vs Output Current
Test Circuit B

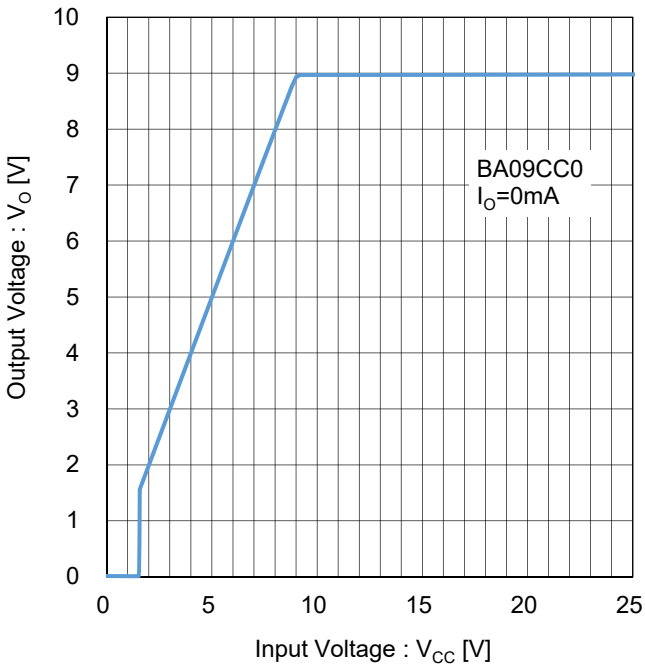

Figure 93. Output Voltage vs Input Voltage
($I_o=0mA$)
Test Circuit C

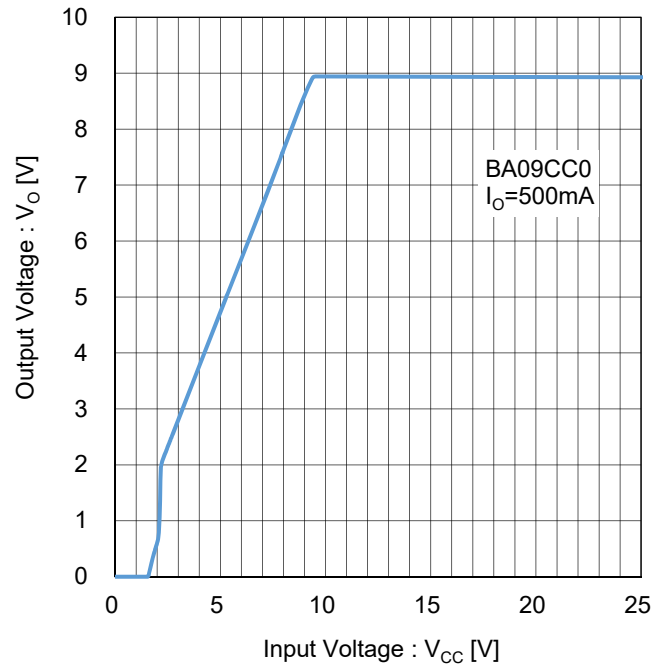

Figure 94. Output Voltage vs Input Voltage
($I_o=500mA$)
Test Circuit C

BA09CC0 (V_O=9.0V)

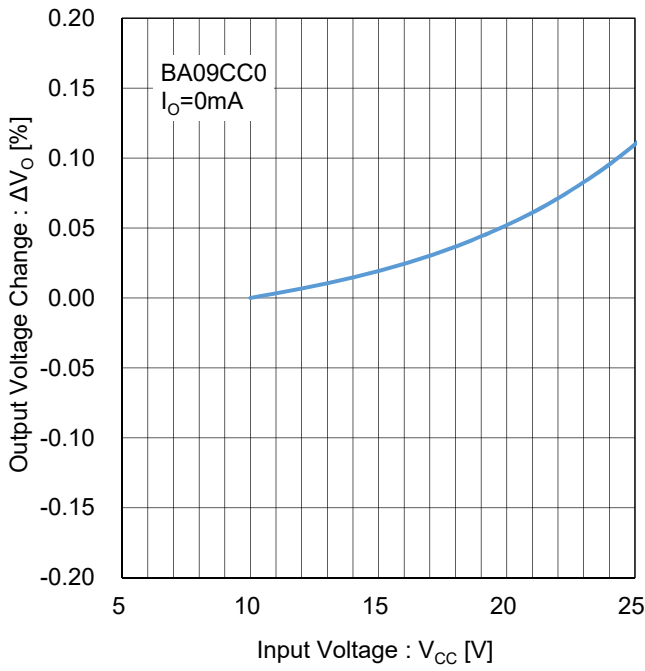

Figure 95. Line Regulation
(I_o=0mA)
Test Circuit D

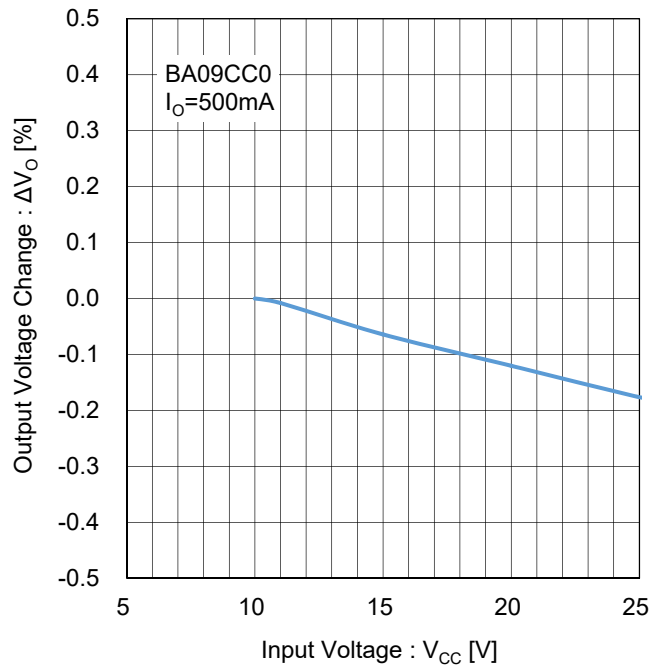

Figure 96. Line Regulation
(I_o=500mA)
Test Circuit D

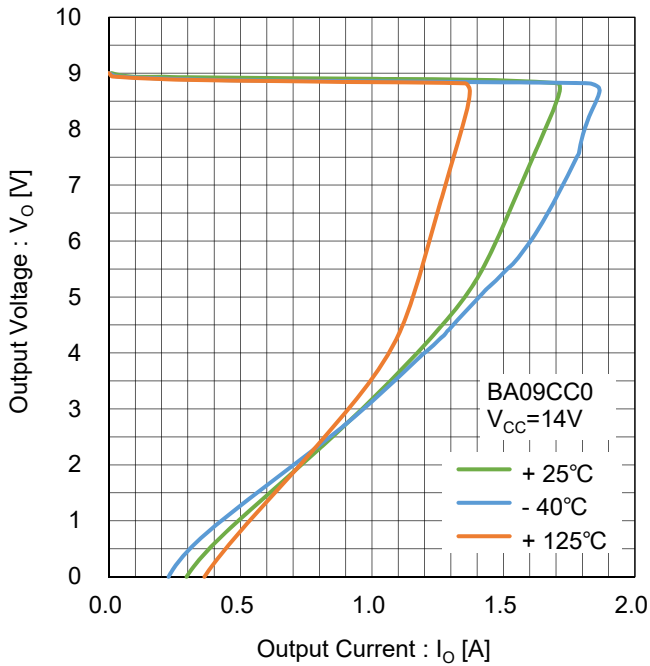

Figure 97. Overcurrent Protection
Test Circuit E

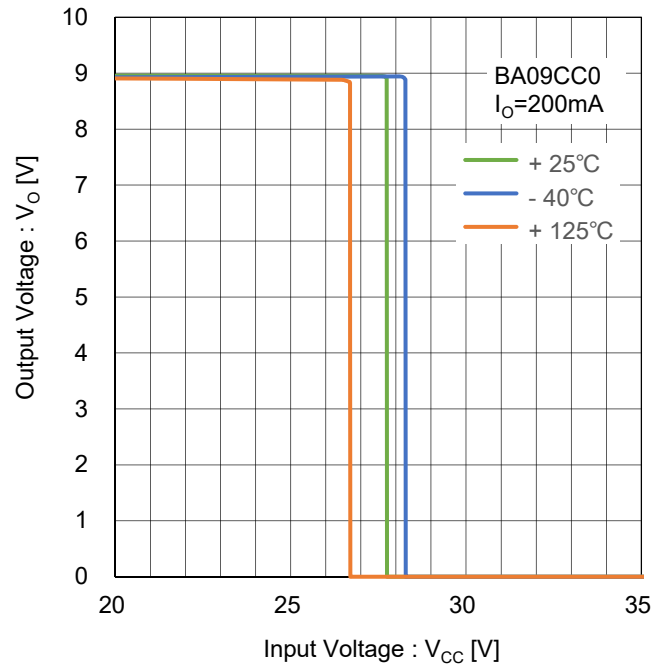

Figure 98. Overvoltage Protection
Test Circuit F

BA09CC0 ($V_O=9.0V$)

Refer to the data of BAJ0CC0

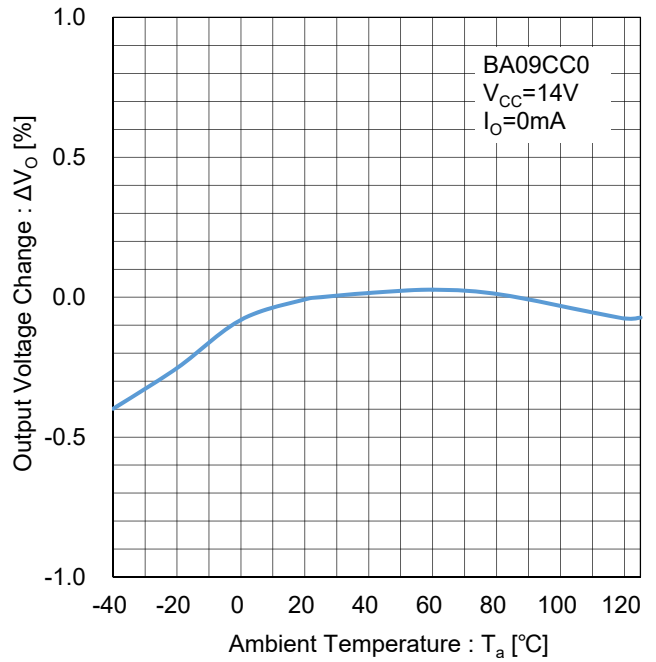

Figure 100. Output Voltage Temperature Stability Test Circuit H

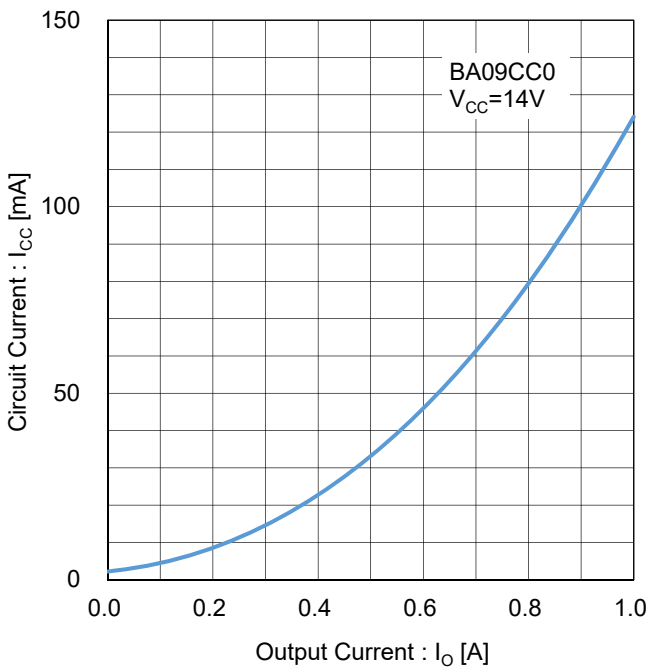

Figure 101. Circuit Current vs Output Current Test Circuit I

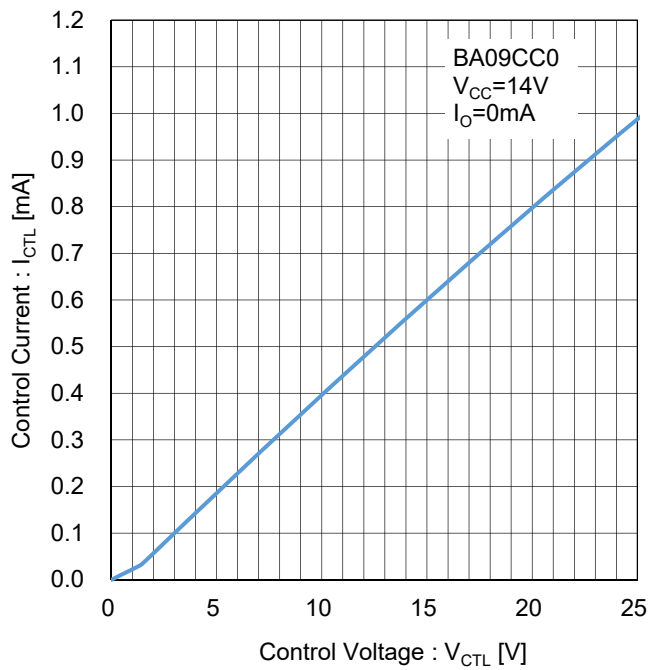

Figure 102. CTL Pin Current Test Circuit J

BA09CC0 ($V_O=9.0V$)

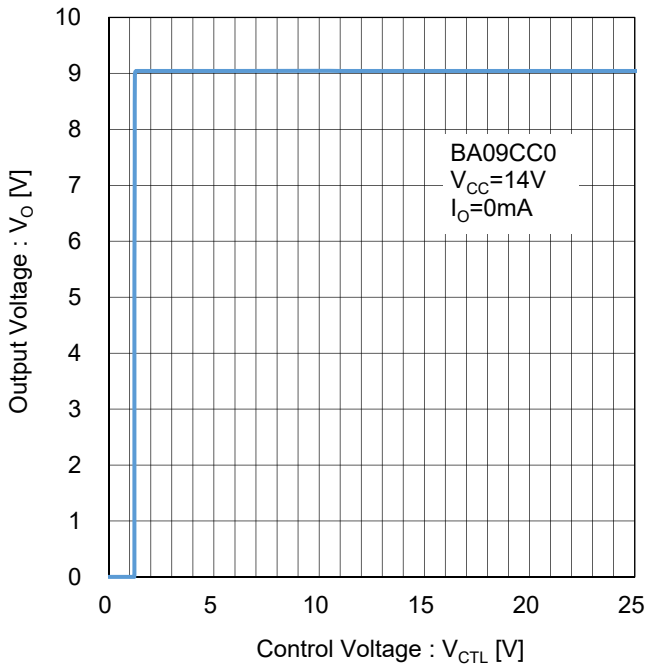

Figure 103. Output Voltage vs CTL Pin Voltage
 Test Circuit K

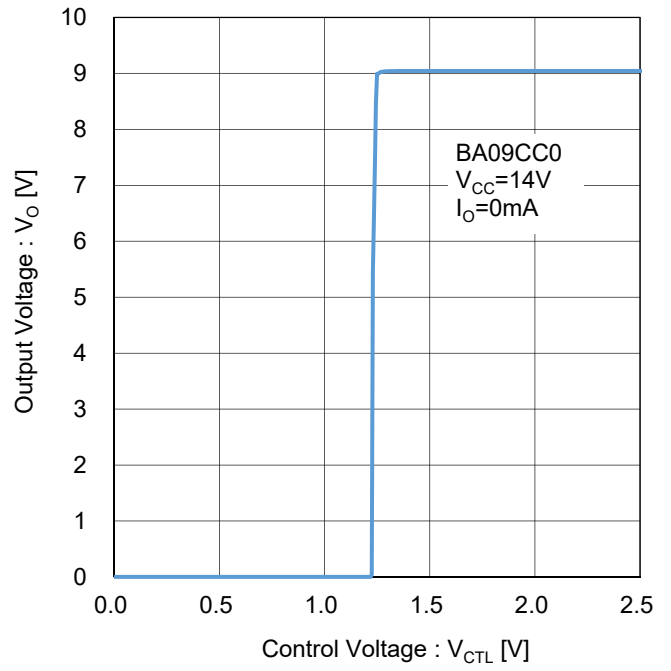

Figure 104. Output Voltage vs CTL Pin Voltage
 Test Circuit K

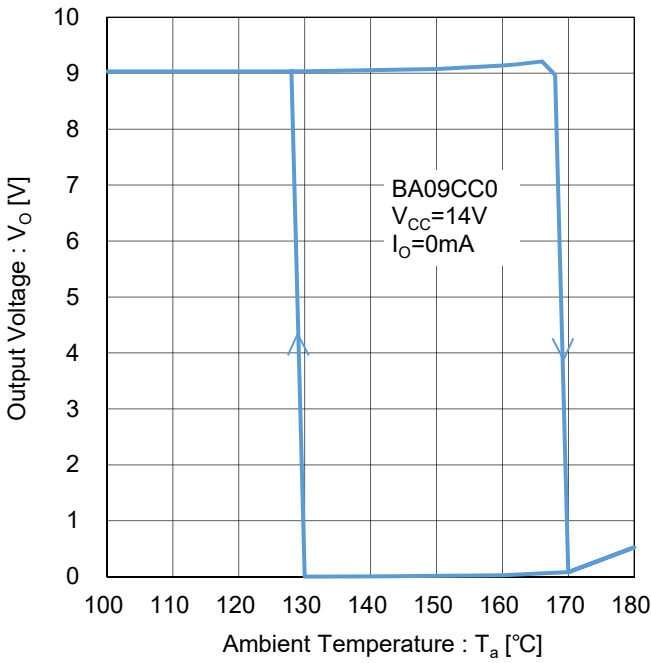

Figure 105. Thermal Shutdown
 Test Circuit L

BAJ0CC0 ($V_o=10V$)

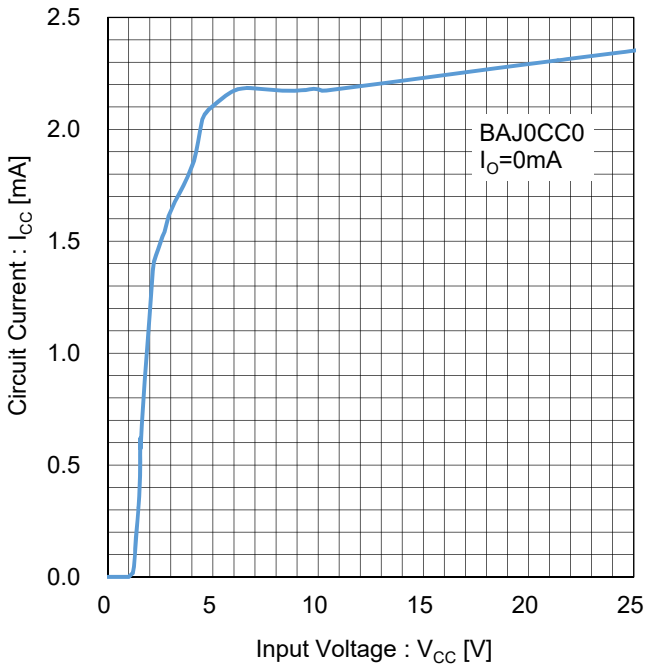

Figure 106. Circuit Current
Test Circuit A

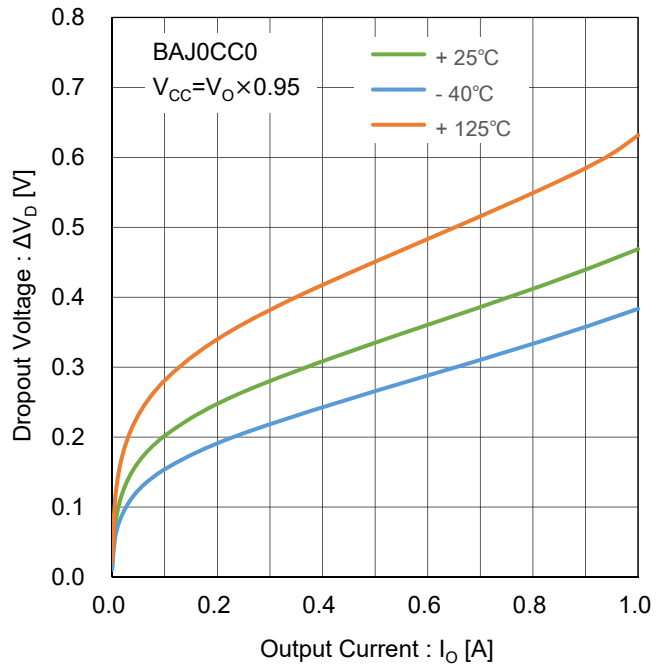

Figure 107. Dropout Voltage vs Output Current
Test Circuit B

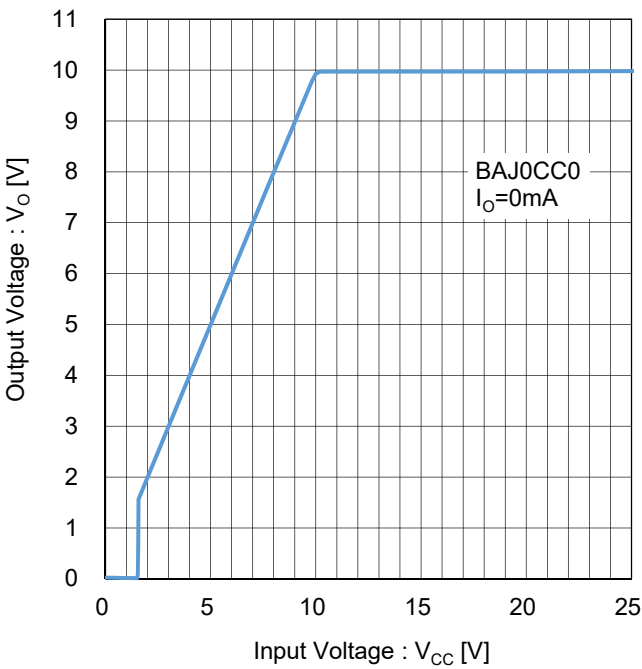

Figure 108. Output Voltage vs Input Voltage
($I_o=0mA$)
Test Circuit C

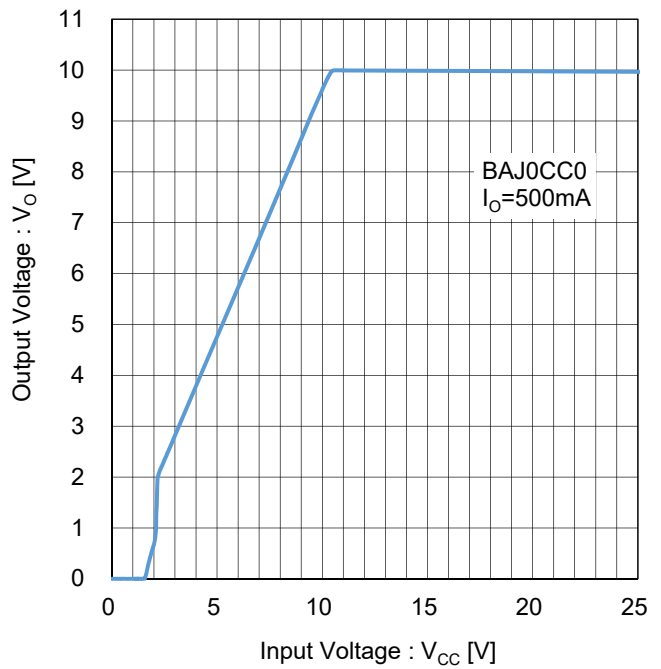

Figure 109. Output Voltage vs Input Voltage
($I_o=500mA$)
Test Circuit C

BAJ0CC0 ($V_O=10V$)

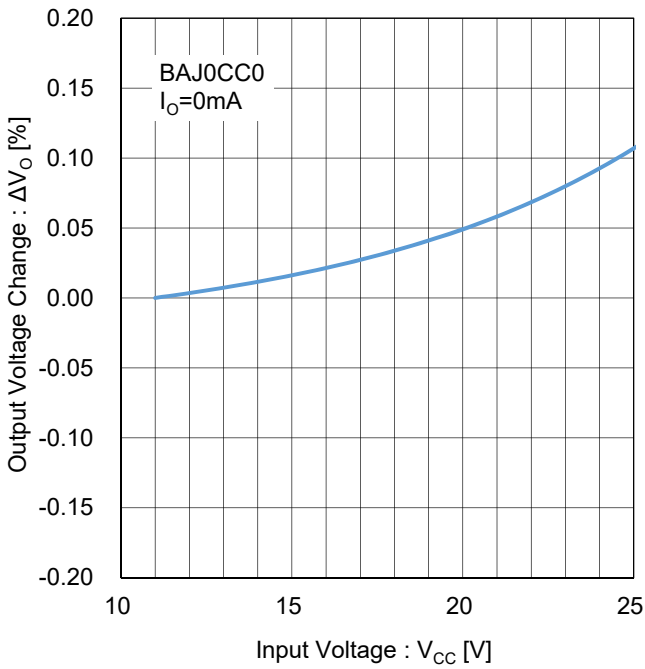

Figure 110. Line Regulation
($I_o=0mA$)
Test Circuit D

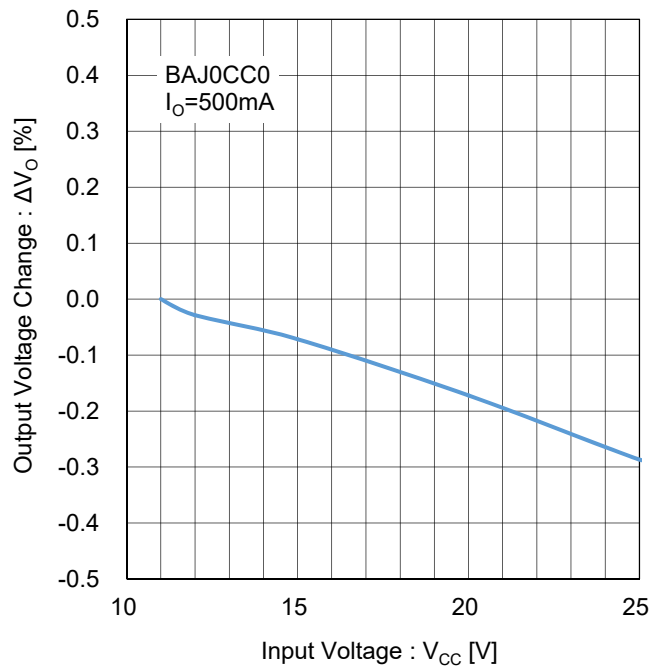

Figure 111. Line Regulation
($I_o=500mA$)
Test Circuit D

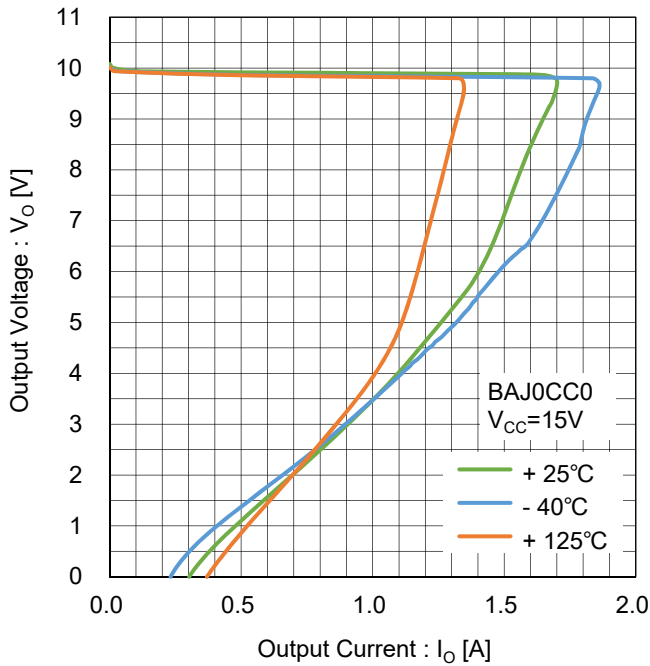

Figure 112. Overcurrent Protection
Test Circuit E

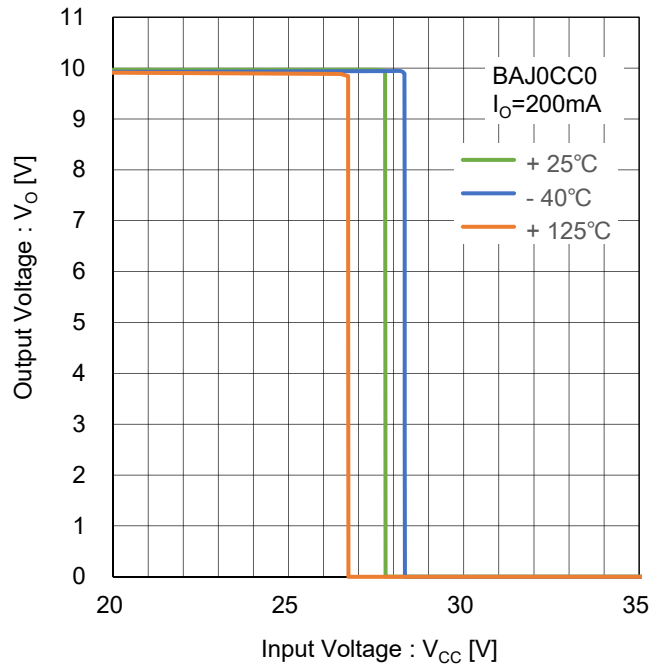

Figure 113. Overvoltage Protection
Test Circuit F

BAJ0CC0 ($V_O=10V$)

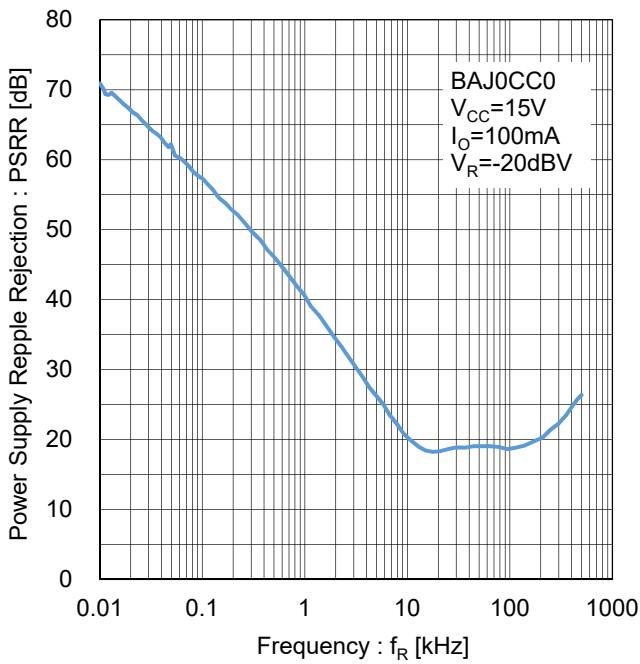

Figure 114. Ripple Rejection
Test Circuit G

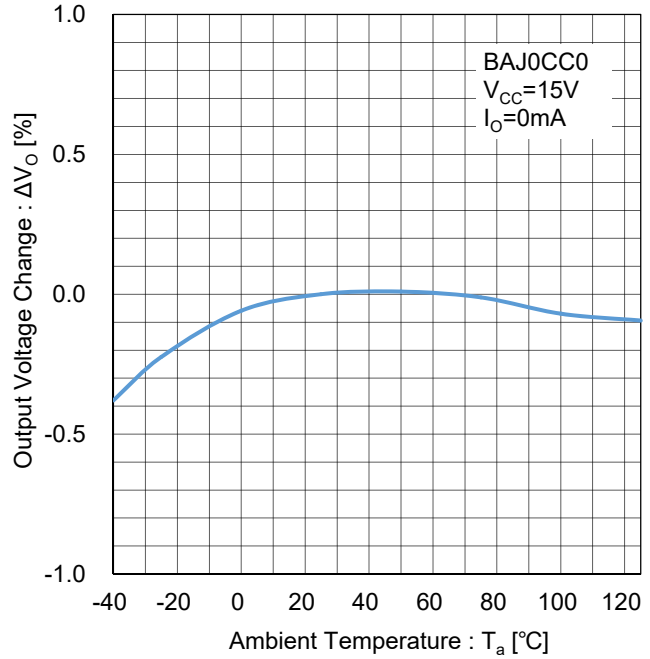

Figure 115. Output Voltage Temperature Stability
Test Circuit H

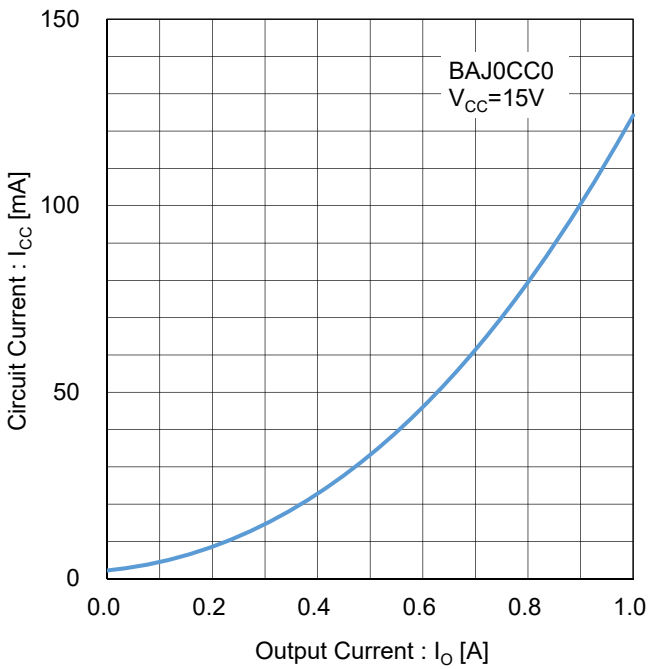

Figure 116. Circuit Current vs Output Current
Test Circuit I

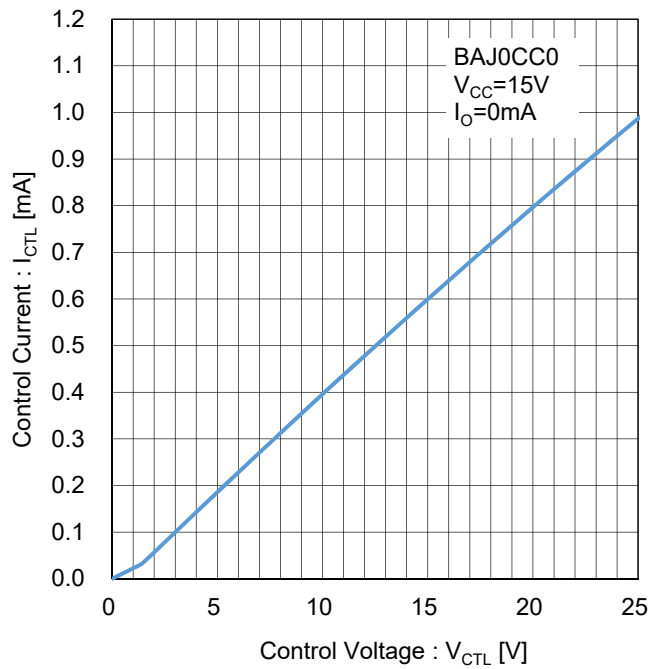

Figure 117. CTL Pin Current
Test Circuit J

BAJ0CC0 ($V_O=10V$)

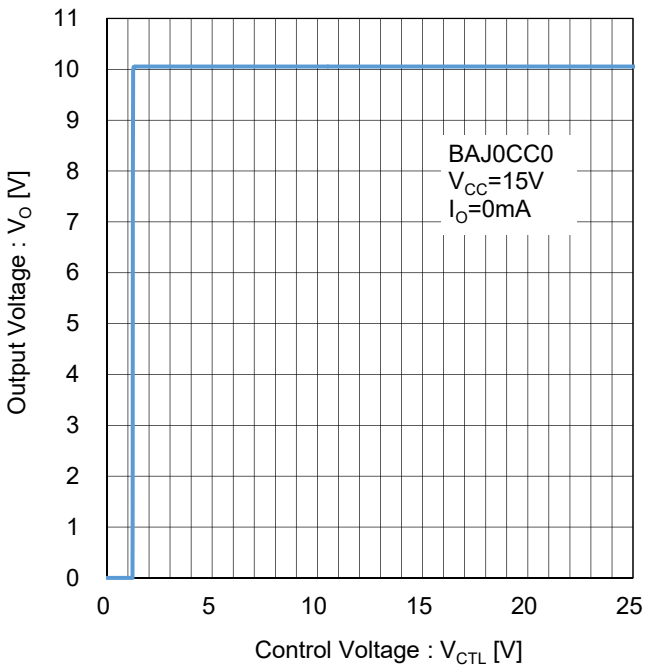

Figure 118. Output Voltage vs CTL Pin Voltage
Test Circuit K

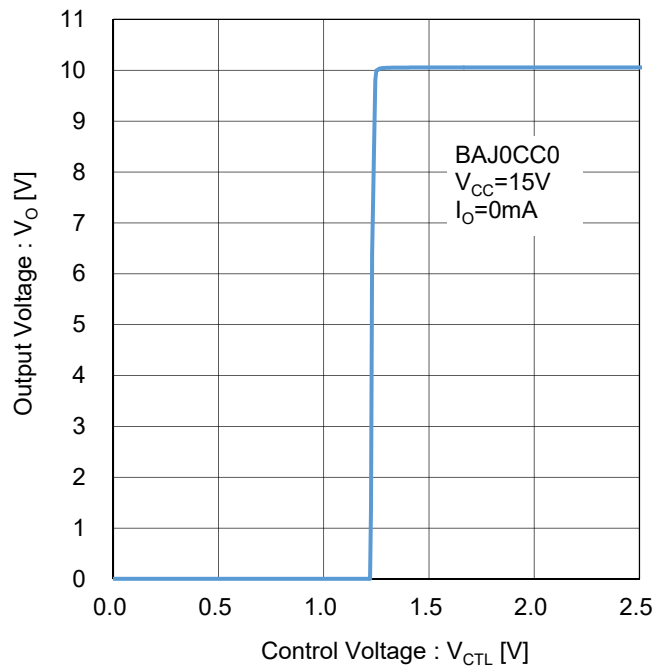

Figure 119. Output Voltage vs CTL Pin Voltage
Test Circuit K

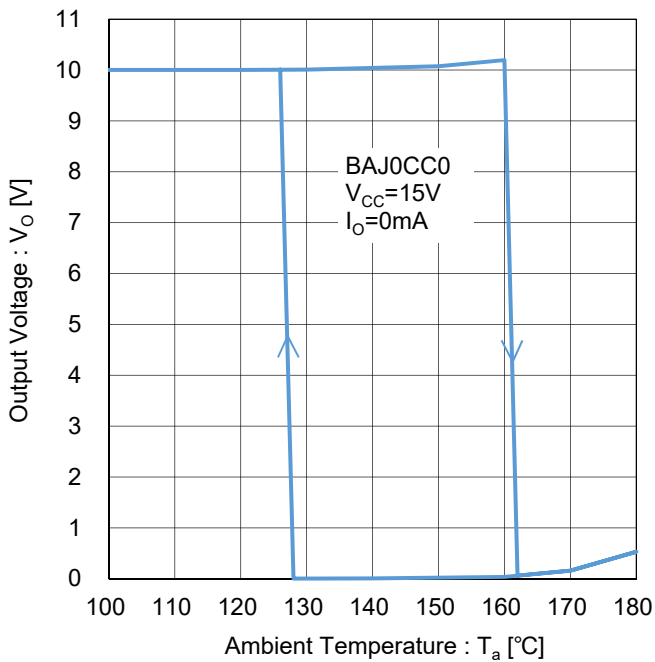

Figure 120. Thermal Shutdown
Test Circuit L

BAJ2CC0 ($V_O=12V$)

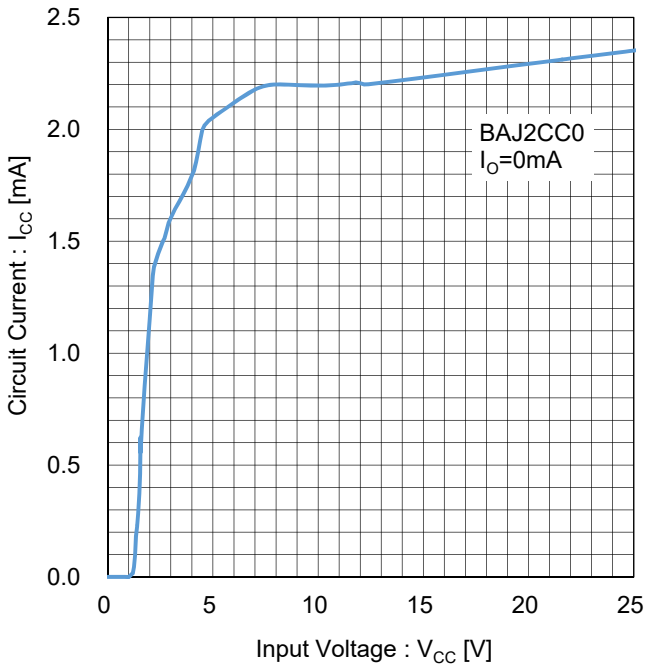

Figure 121. Circuit Current
Test Circuit A

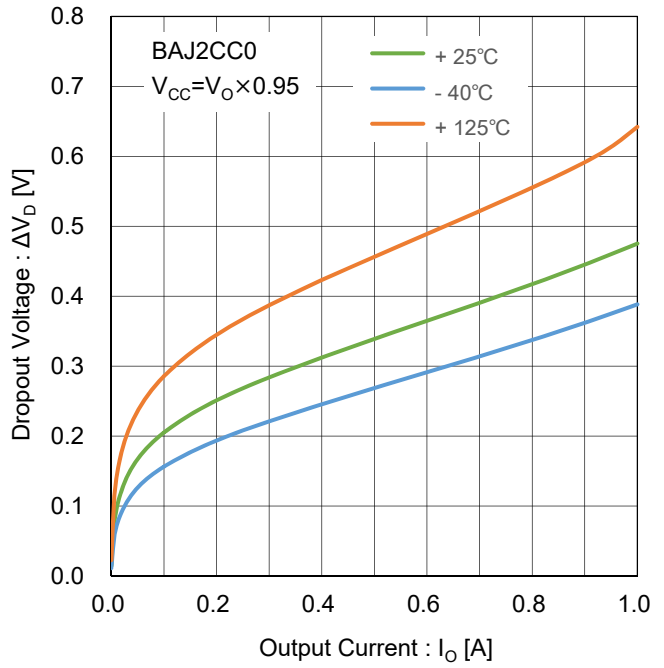

Figure 122. Dropout Voltage vs Output Current
Test Circuit B

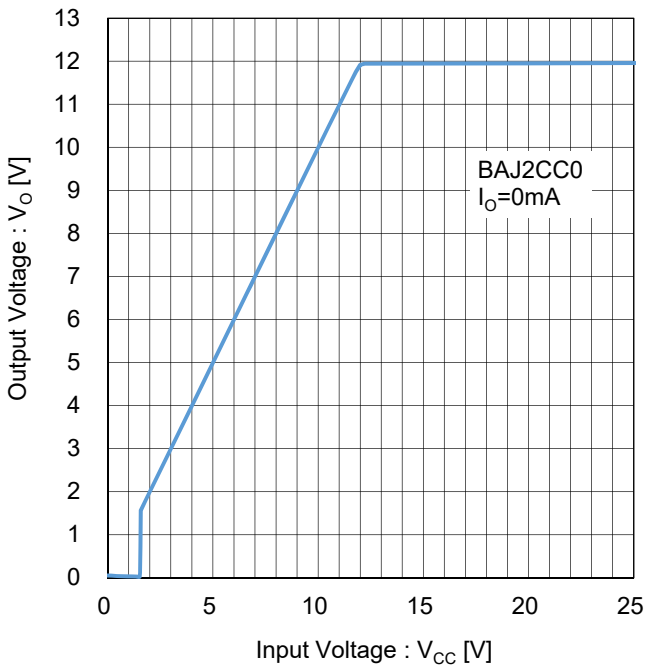

Figure 123. Output Voltage vs Input Voltage
($I_o=0mA$)
Test Circuit C

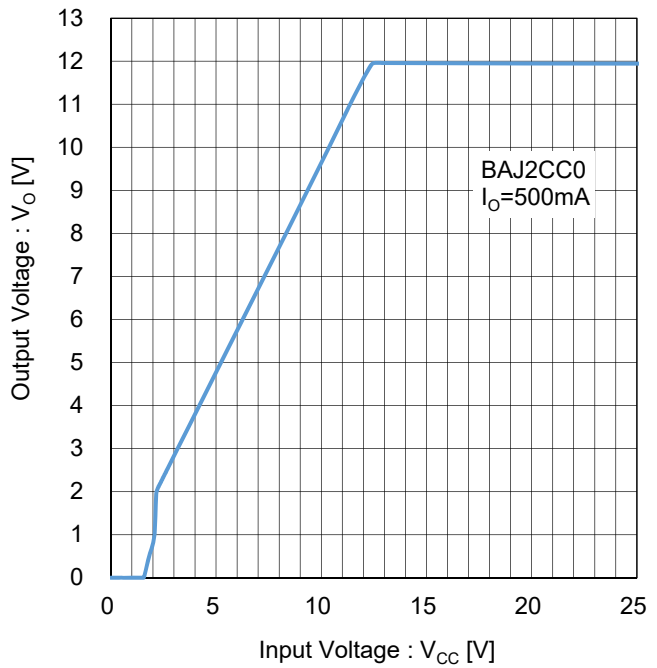

Figure 124. Output Voltage vs Input Voltage
($I_o=500mA$)
Test Circuit C

BAJ2CC0 (V_O=12V)

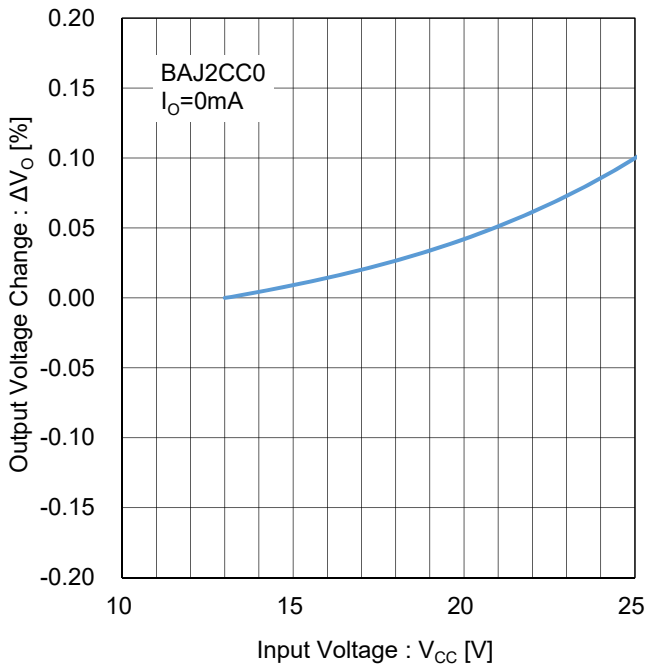

Figure 125. Line Regulation
(I_o=0mA)
Test Circuit D

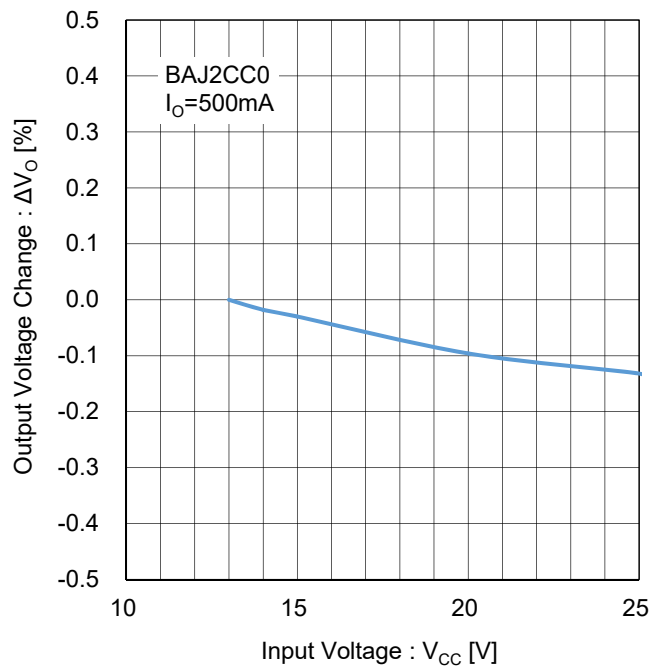

Figure 126. Line Regulation
(I_o=500mA)
Test Circuit D

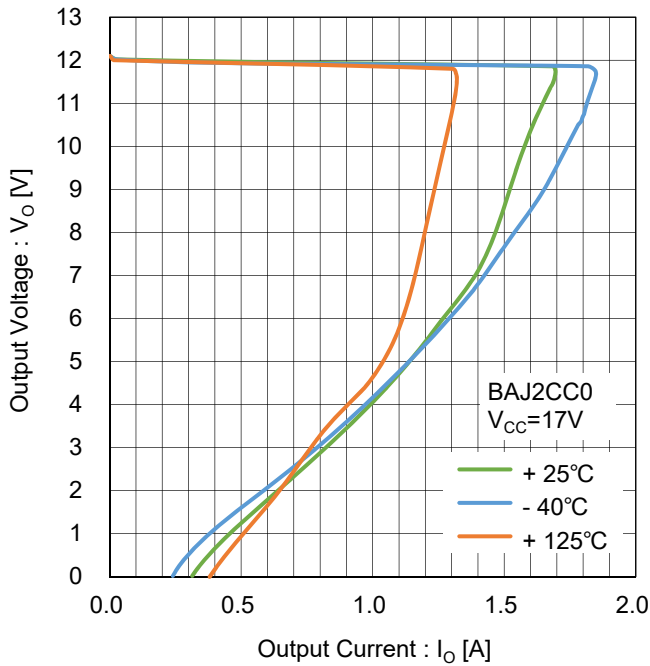

Figure 127. Overcurrent Protection
Test Circuit E

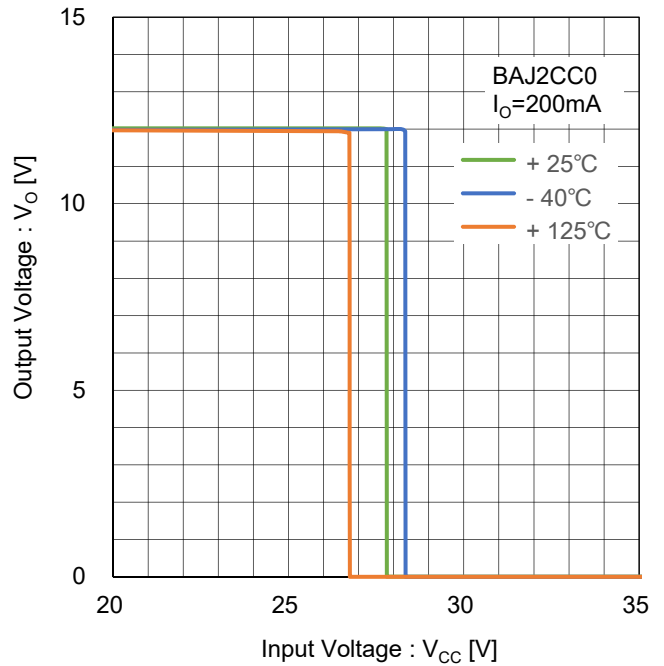

Figure 128. Overvoltage Protection
Test Circuit F

BAJ2CC0 ($V_o=12V$)

Refer to the data of BAJ0CC0

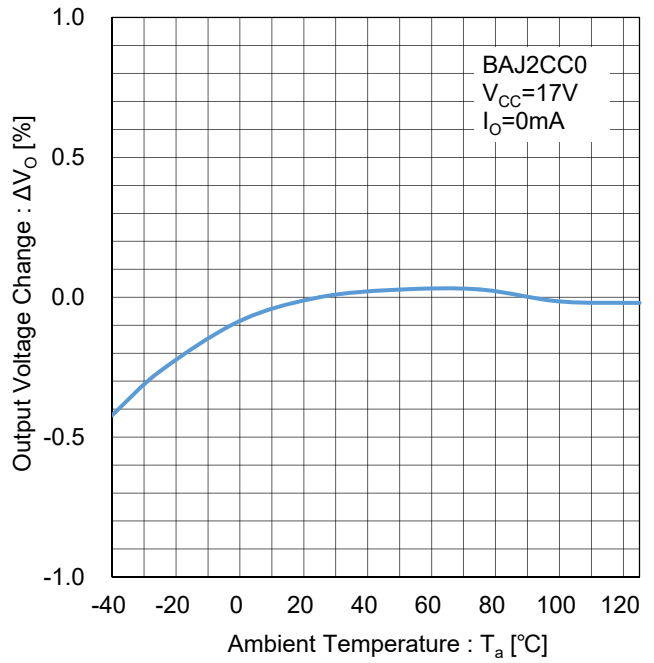

Figure 130. Output Voltage Temperature Stability Test Circuit H

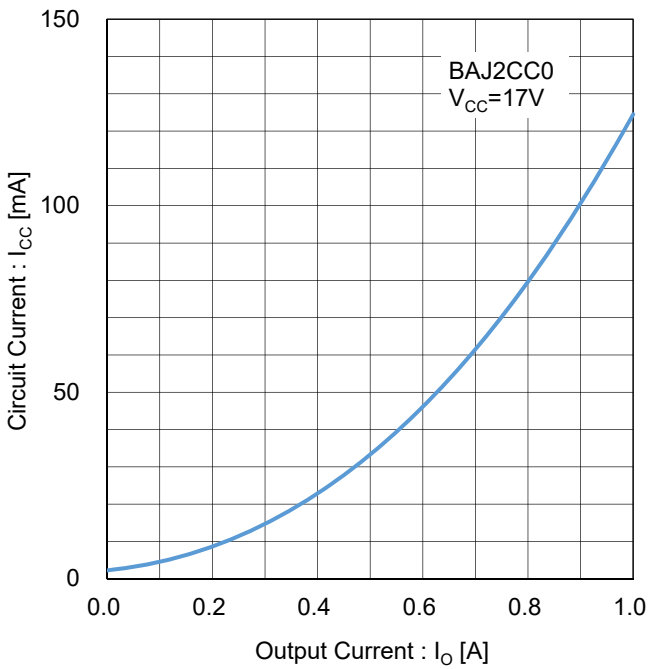

Figure 131. Circuit Current vs Output Current Test Circuit I

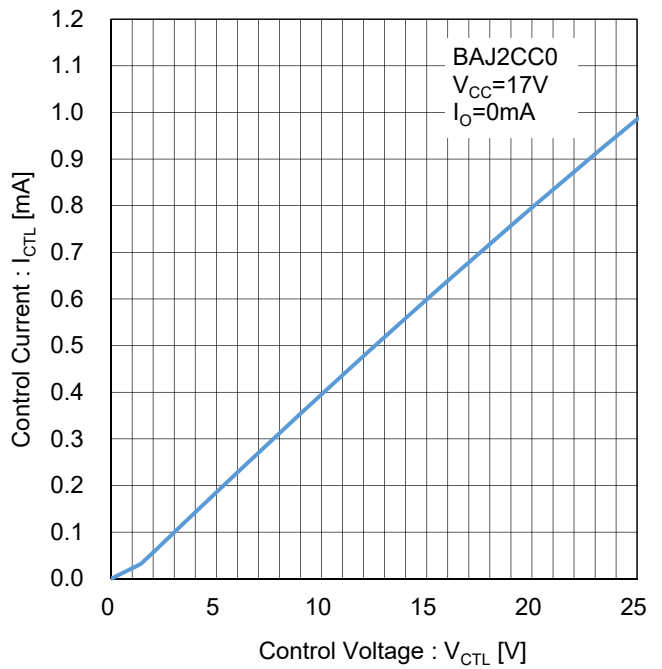

Figure 132. CTL Pin Current Test Circuit J

BAJ2CC0 ($V_o=12V$)

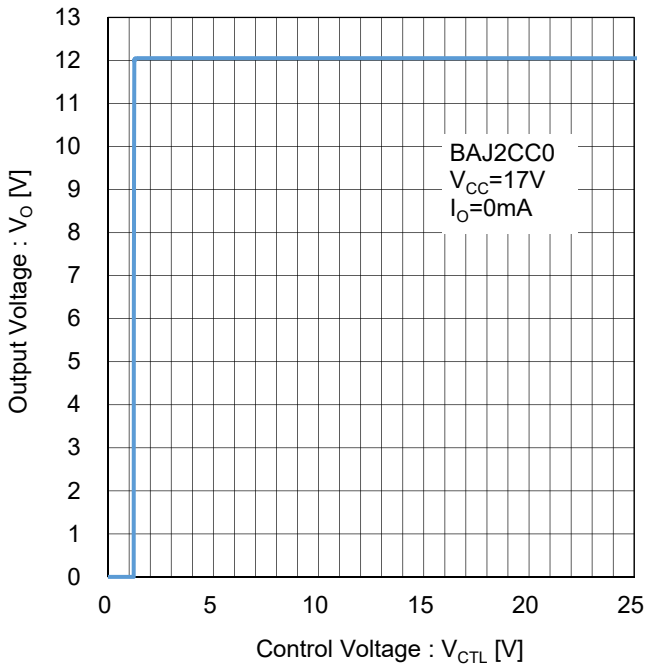

Figure 133. Output Voltage vs CTL Pin Voltage
Test Circuit K

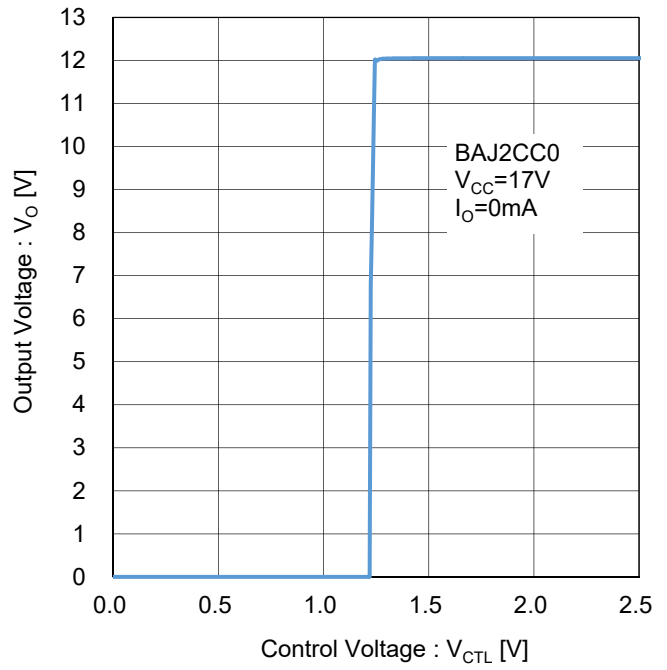

Figure 134. Output Voltage vs CTL Pin Voltage
Test Circuit K

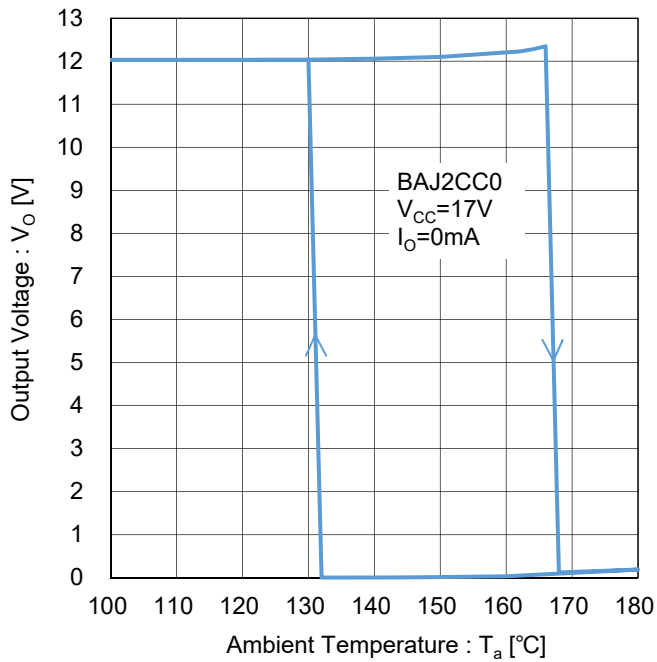

Figure 135. Thermal Shutdown
Test Circuit L

BAJ5CC0 ($V_o=15V$)

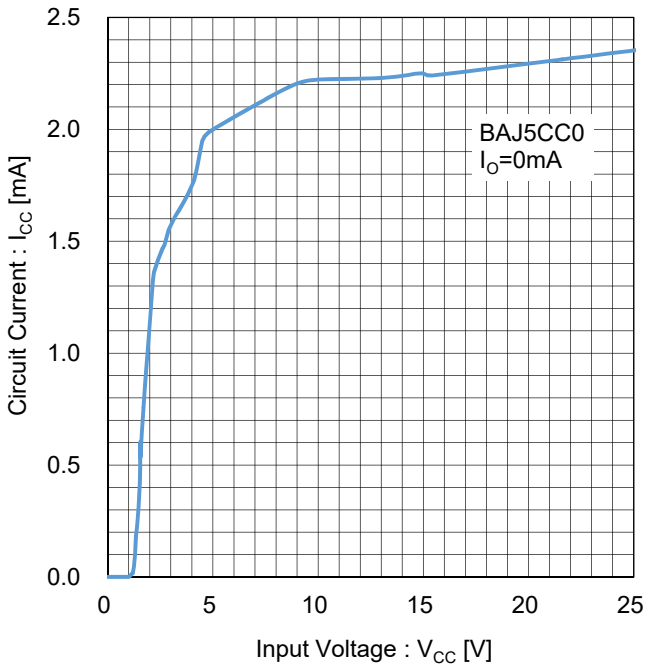

Figure 136. Circuit Current
Test Circuit A

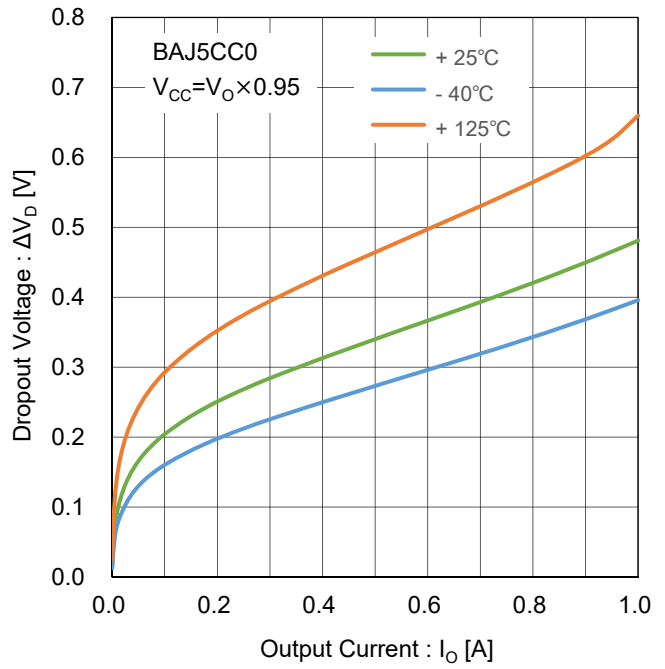

Figure 137. Dropout Voltage vs Output Current
Test Circuit B

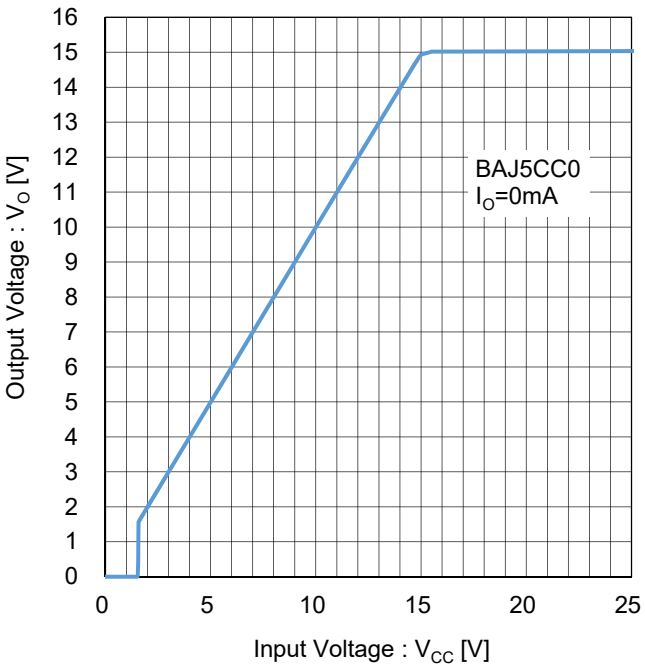

Figure 138. Output Voltage vs Input Voltage
($I_o=0mA$)
Test Circuit C

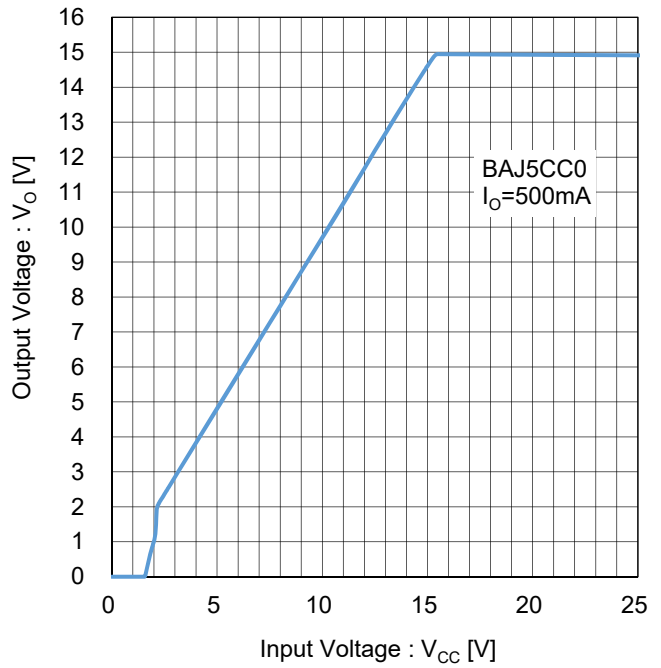

Figure 139. Output Voltage vs Input Voltage
($I_o=500mA$)
Test Circuit C

BAJ5CC0 (V_O=15V)

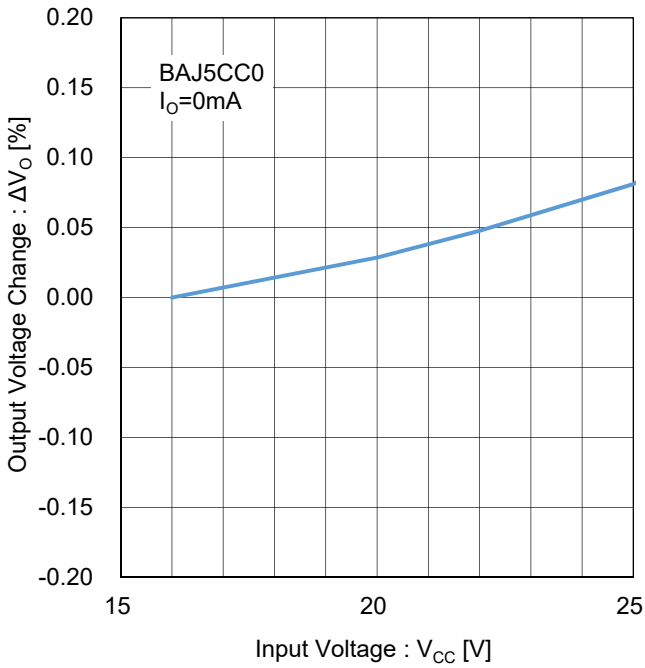

Figure 140. Line Regulation
(I_o=0mA)
Test Circuit D

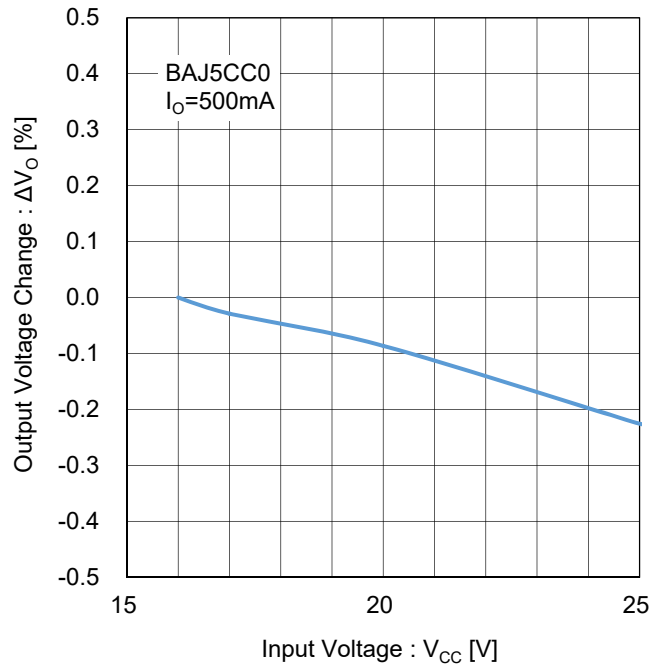

Figure 141. Line Regulation
(I_o=500mA)
Test Circuit D

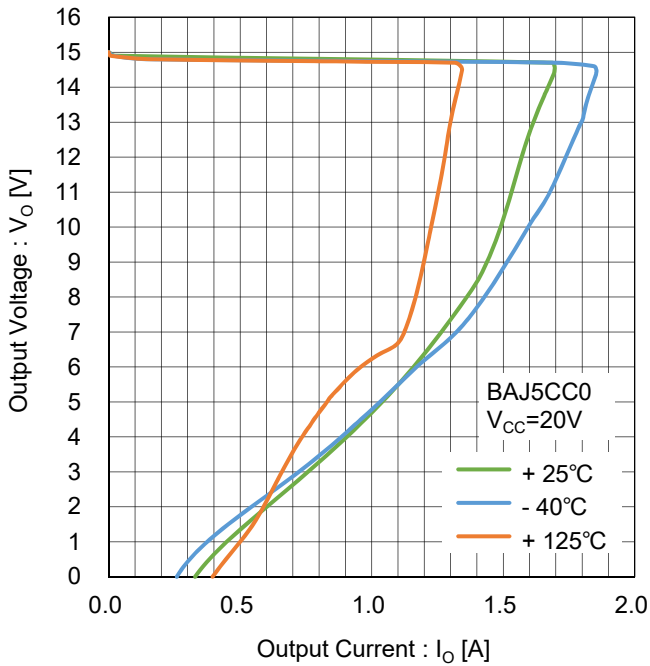

Figure 142. Overcurrent Protection
Test Circuit E

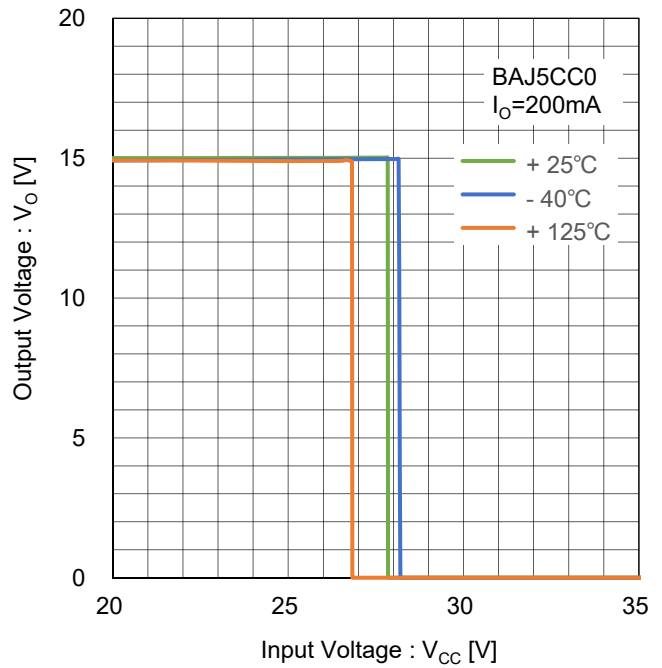

Figure 143. Overvoltage Protection
Test Circuit F

BAJ5CC0 ($V_o=15V$)

Refer to the data of BAJ0CC0

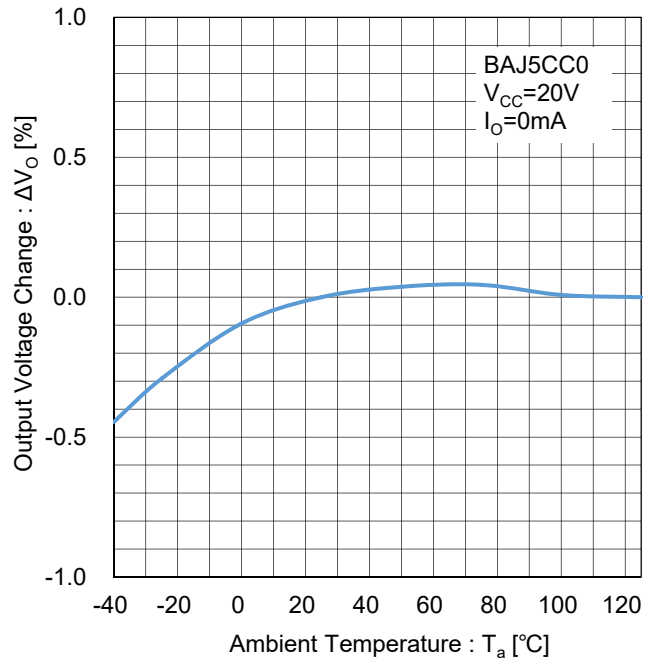

Figure 145. Output Voltage Temperature Stability Test Circuit H

Figure 144. Ripple Rejection Test Circuit G

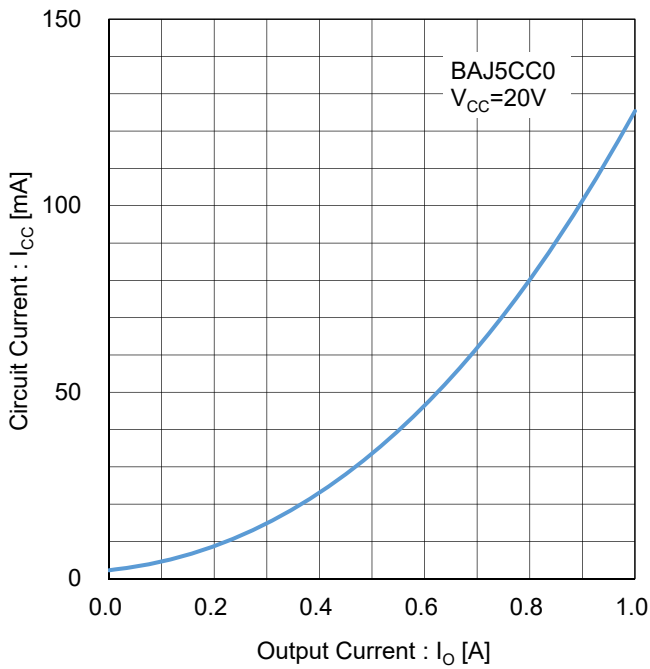

Figure 146. Circuit Current vs Output Current Test Circuit I

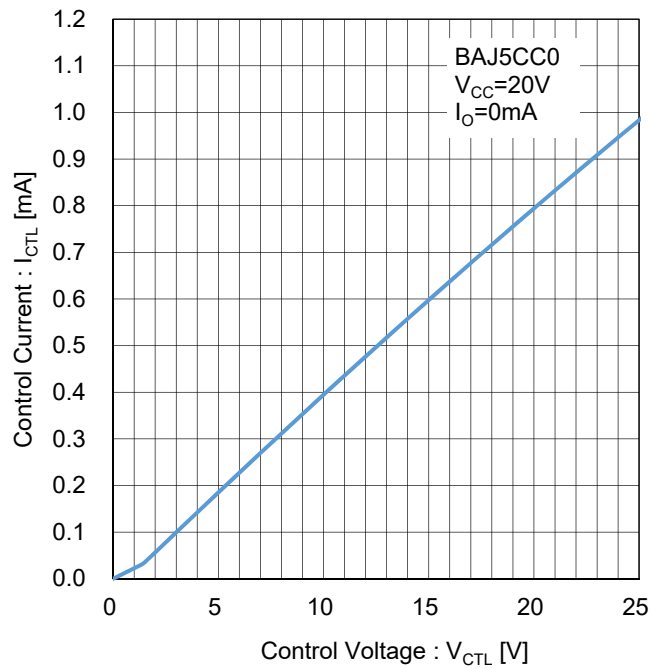

Figure 147. CTL Pin Current Test Circuit J

BAJ5CC0 ($V_o=15V$)

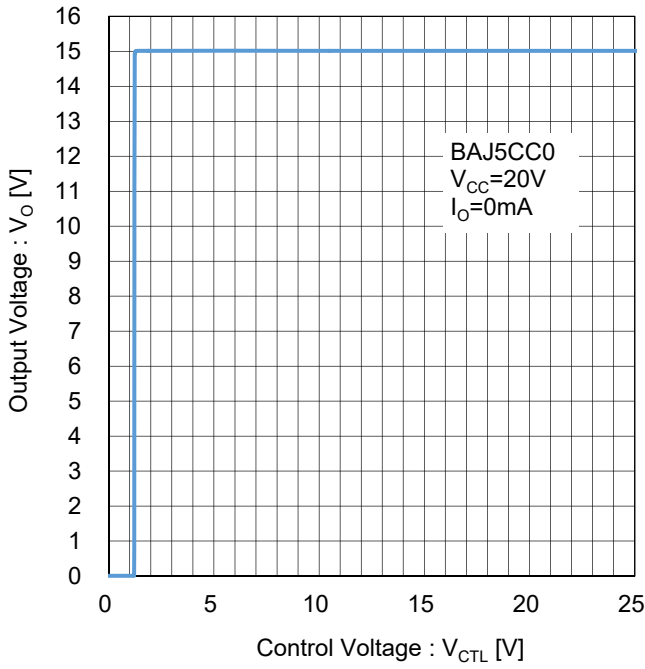

Figure 148. Output Voltage vs CTL Pin Voltage
Test Circuit K

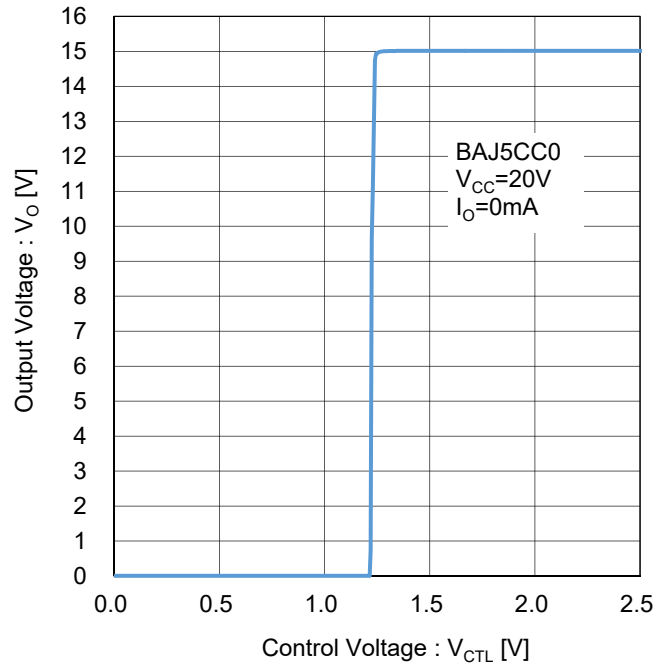

Figure 149. Output Voltage vs CTL Pin Voltage
Test Circuit K

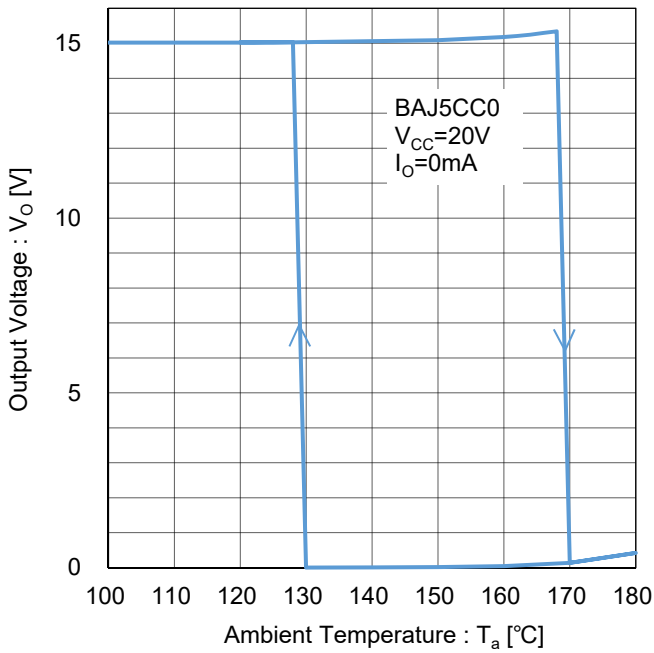
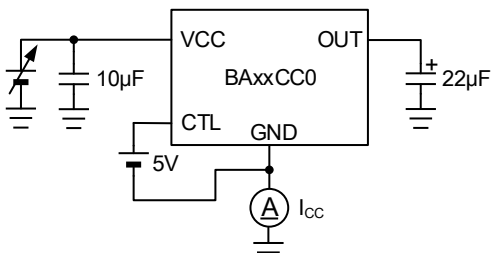
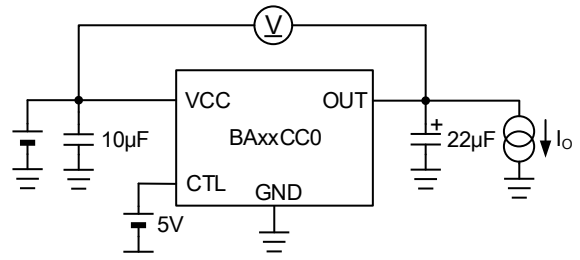

Figure 150. Thermal Shutdown
Test Circuit L

Test Circuits



Test Circuit A. Circuit Current



Test Circuit B. Dropout Voltage vs Output Current

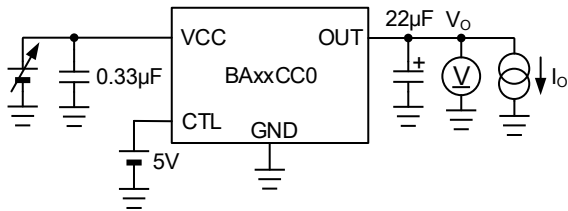

Test Circuit C. Output Voltage vs Input Voltage

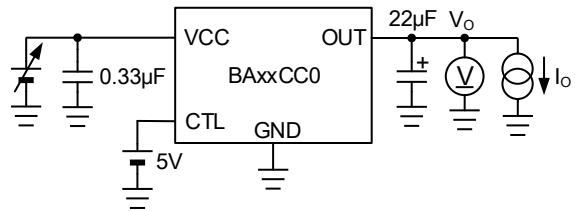

Test Circuit D. Line Regulation

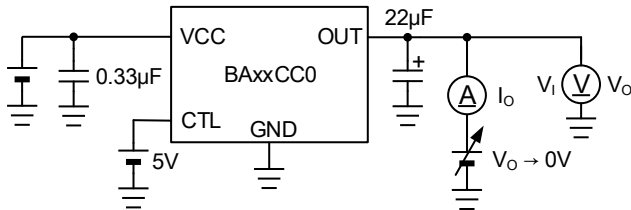

Test Circuit E. Overcurrent Protection

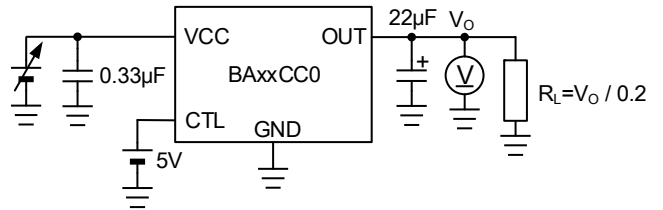

Test Circuit F. Overvoltage Protection

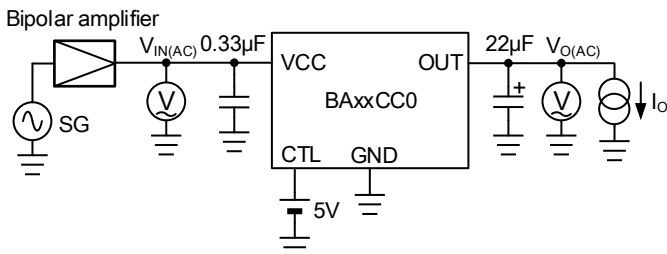

Test Circuit G. Ripple Rejection

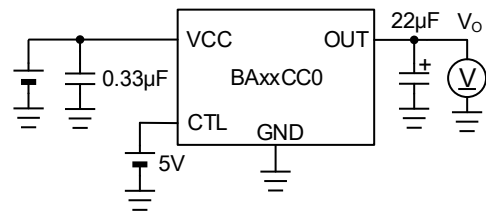

Test Circuit H. Output Voltage Temperature Stability

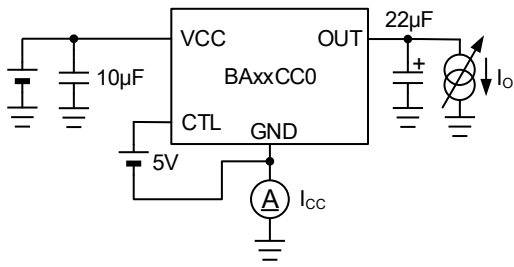

Test Circuit I. Circuit Current vs Output Current

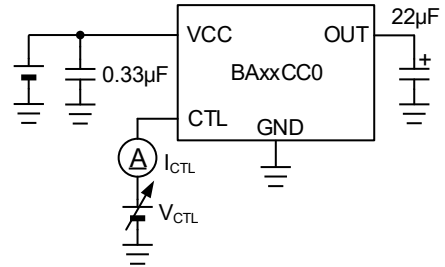

Test Circuit J. CTL Pin Current

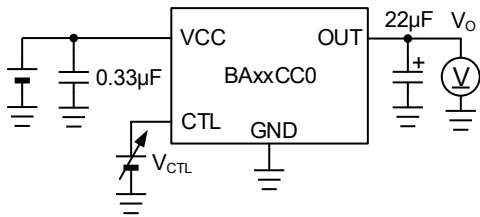

Test Circuit K. Output Voltage vs CTL Pin Voltage

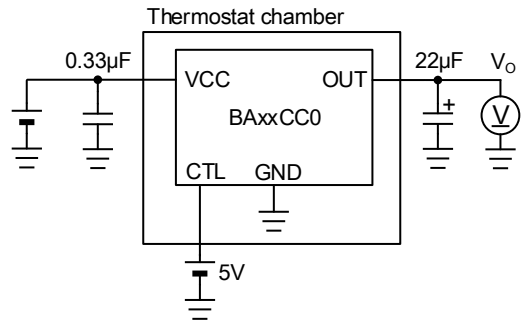

Test Circuit L. Thermal Shutdown

Notes

- 1) The information contained herein is subject to change without notice.
- 2) Before you use our Products, please contact our sales representative and verify the latest specifications :
- 3) Although ROHM is continuously working to improve product reliability and quality, semiconductors can break down and malfunction due to various factors.
Therefore, in order to prevent personal injury or fire arising from failure, please take safety measures such as complying with the derating characteristics, implementing redundant and fire prevention designs, and utilizing backups and fail-safe procedures. ROHM shall have no responsibility for any damages arising out of the use of our Products beyond the rating specified by ROHM.
- 4) Examples of application circuits, circuit constants and any other information contained herein are provided only to illustrate the standard usage and operations of the Products. The peripheral conditions must be taken into account when designing circuits for mass production.
- 5) The technical information specified herein is intended only to show the typical functions of and examples of application circuits for the Products. ROHM does not grant you, explicitly or implicitly, any license to use or exercise intellectual property or other rights held by ROHM or any other parties. ROHM shall have no responsibility whatsoever for any dispute arising out of the use of such technical information.
- 6) The Products are intended for use in general electronic equipment (i.e. AV/OA devices, communication, consumer systems, gaming/entertainment sets) as well as the applications indicated in this document.
- 7) The Products specified in this document are not designed to be radiation tolerant.
- 8) For use of our Products in applications requiring a high degree of reliability (as exemplified below), please contact and consult with a ROHM representative : transportation equipment (i.e. cars, ships, trains), primary communication equipment, traffic lights, fire/crime prevention, safety equipment, medical systems, servers, solar cells, and power transmission systems.
- 9) Do not use our Products in applications requiring extremely high reliability, such as aerospace equipment, nuclear power control systems, and submarine repeaters.
- 10) ROHM shall have no responsibility for any damages or injury arising from non-compliance with the recommended usage conditions and specifications contained herein.
- 11) ROHM has used reasonable care to ensure the accuracy of the information contained in this document. However, ROHM does not warrants that such information is error-free, and ROHM shall have no responsibility for any damages arising from any inaccuracy or misprint of such information.
- 12) Please use the Products in accordance with any applicable environmental laws and regulations, such as the RoHS Directive. For more details, including RoHS compatibility, please contact a ROHM sales office. ROHM shall have no responsibility for any damages or losses resulting non-compliance with any applicable laws or regulations.
- 13) When providing our Products and technologies contained in this document to other countries, you must abide by the procedures and provisions stipulated in all applicable export laws and regulations, including without limitation the US Export Administration Regulations and the Foreign Exchange and Foreign Trade Act.
- 14) This document, in part or in whole, may not be reprinted or reproduced without prior consent of ROHM.



Thank you for your accessing to ROHM product informations.
More detail product informations and catalogs are available, please contact us.

ROHM Customer Support System

<http://www.rohm.com/contact/>