

Thermal Design

HTSOP-J8 Package Thermal Resistance Information (s)

Supported product numbers: BD4xxM2EFJ-C series, BD4xxM2WEFJ-C series, BD4xxU2EFJ-C series, BD4xxU2WEFJ-C series, BD7xxL2EFJ-C series, BD7xxU2EFJ-C series, BD42530EFJ-C, BD42530UEFJ-C, BD820F50EFJ-C, BD820F5UEFJ-C

This application note provides information on the thermal resistances required for performing thermal design using the HTSOP-J8 package. Use this information for the reference values in the temperature estimation during the initial designing.

Contents

1. Package overview	2
2. Thermal resistances and thermal characteristics parameters under environment in accordance with JEDEC standard	2
2-1. Measurement environment	2
2-2. Numerical values	2
2-3. PCB specifications, 1 layer (1s)	3
2-4. PCB specifications, 4 layers (2s2p)	4
3. Thermal resistances and thermal characteristics parameters with changes in various parameters	5
3-1. Change in copper foil area	5
3-1-1. 1 layer	5
3-1-2. 2 layers	6
3-1-3. 4 layers, change in copper foil area of multiple layers	7
3-1-4. 4 layers, change in copper foil area of bottom layer only	8
3-1-5. 6 layers, change in copper foil area of multiple layers	9
3-1-6. 6 layers, change in copper foil area of bottom layer only	10
3-1-7. 8 layers, change in copper foil area of multiple layers	11
3-1-8. 8 layers, change in copper foil area of bottom layer only	12
3-2. Change in copper foil thickness	13
3-2-1. 1 layer	13
3-2-2. 2 layers	14
3-2-3. 4 layers	15
3-3. Thermal via configuration	16
3-3-1. 2 layers	16
3-3-2. 4 layers	17
3-4. Change in board thickness	18
3-4-1. 1 layer	18
3-4-2. 2 layers	19
3-4-3. 4 layers	20
4. Transient thermal resistance	21
4-1. Transient thermal resistance, 1 layer	21
4-2. Transient thermal resistance, 2 layers	24
4-3. Transient thermal resistance, 4 layers	25

1. Package overview

Package name: HTSOP-J8

Package group: SOP

Outline dimensions: W (typ) D (typ) H (max)

4.9 mm × 6.0 mm × 1.0 mm

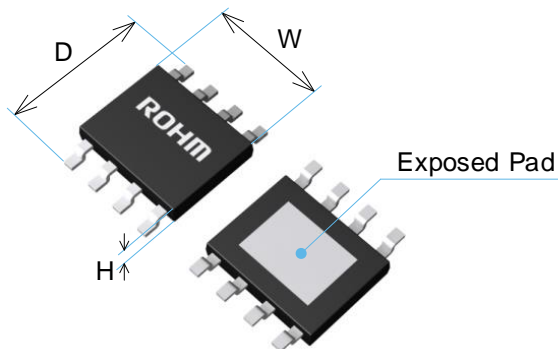

2. Thermal resistances and thermal characteristics parameters under environment in accordance with JEDEC standard

2-1. Measurement environment

Content	Standard
Measurement environment	JEDEC STANDARD JESD51-2A (Still Air)
Measurement board standard	JEDEC STANDARD JESD51-3 JESD51-5 JESD51-7

2-2. Numerical values

Configuration	θ_{JA} (°C/W)	Ψ_{JT} (°C/W)
1 layer (1s)	130.4	15
4 layers (2s2p)	29.2	5

θ_{JA} : Thermal resistance between junction temperature T_J and ambient temperature T_A

Ψ_{JT} : Thermal characteristics parameter between junction temperature T_J and package surface center temperature T_T

Note: The thermal resistances and thermal characteristics parameters in this application note are values under a measurement environment in accordance with the JEDEC standard and may not always be consistent with the values for actual equipment. It is necessary to consider variations in the values due to the PCB characteristics, PCB layout, parts layout, chassis shape, surrounding environment, and so on.

2-3. PCB specifications, 1 layer (1s)

Conforms to JEDEC standard JESD51

Item		Value
Board thickness		1.57mm
Board outline dimensions		76.2 mm × 114.3 mm
Board material		FR-4
Trace thickness (Finished thickness)	Top	70 μm (2 oz)
Lead width		0.254mm
Copper foil area	Top	15.7mm ² (Footprint)

Table 2-3-1. 1-layer PCB specifications



Figure 2-3-1. 1-layer board sectional view

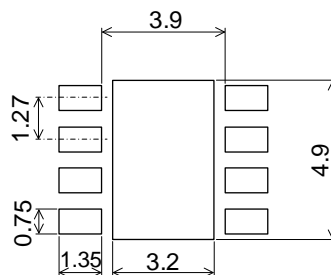

Figure 2-3-2. Footprint dimensions

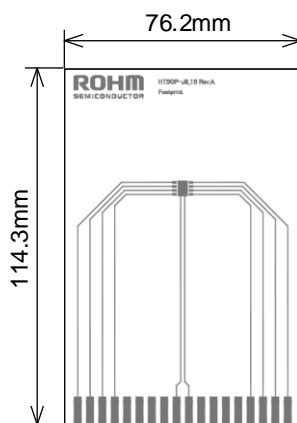

Figure 2-3-3. Top layer

2-4. PCB specifications, 4 layers (2s2p)

Conforms to JEDEC standard JESD51

Item		Value
Board thickness		1.60mm
Board outline dimensions		76.2 mm × 114.3 mm
Board material		FR-4
Trace thickness (Finished thickness)	Top	70 μm (2 oz)
	Middle 1	35 μm (1 oz)
	Middle 2	35 μm (1 oz)
	Bottom	70 μm (2 oz)
Lead width		0.254mm
Copper foil area	Top	15.7mm ² (Footprint)
	Middle 1	5,505 mm ² (74.2 mm × 74.2 mm)
	Middle 2	5,505 mm ² (74.2 mm × 74.2 mm)
	Bottom	5,505 mm ² (74.2 mm × 74.2 mm)

Table 2-4-1. 4-layer PCB specifications

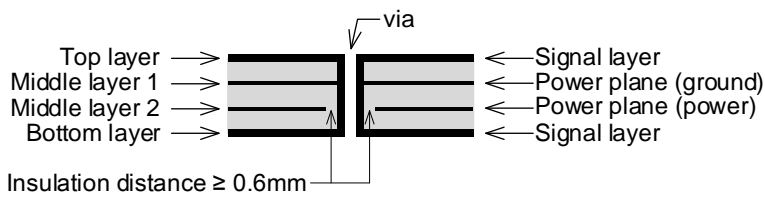

The middle layers are spaced equally in the thickness direction

Figure 2-4-2. 4-layer board sectional view

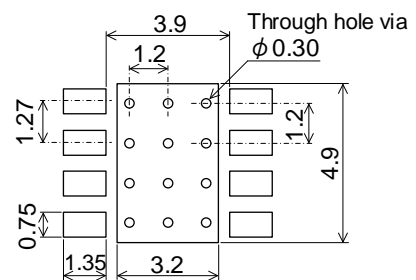

Figure 2-4-3. Footprint dimensions

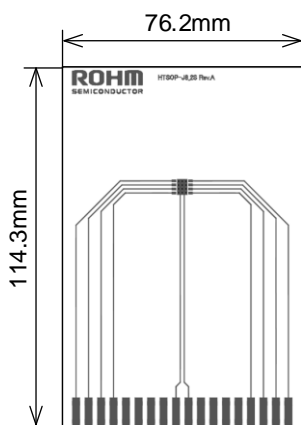

Figure 2-4-4.
Top layer

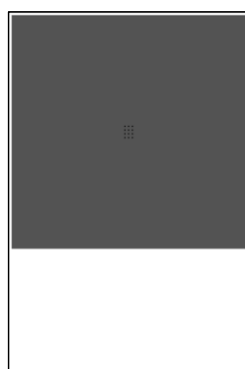

Figure 2-4-5.
Middle 1 layer

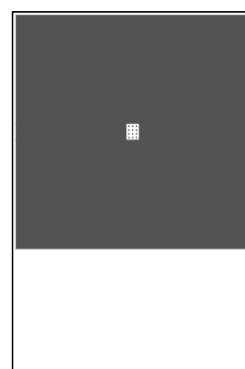

Figure 2-4-6.
Middle 2 layer

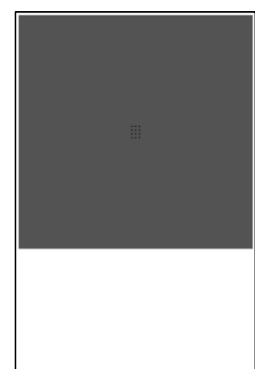

Figure 2-4-7.
Bottom layer

3. Thermal resistances and thermal characteristics parameters with changes in various parameters

3-1. Change in copper foil area

3-1-1. 1 layer

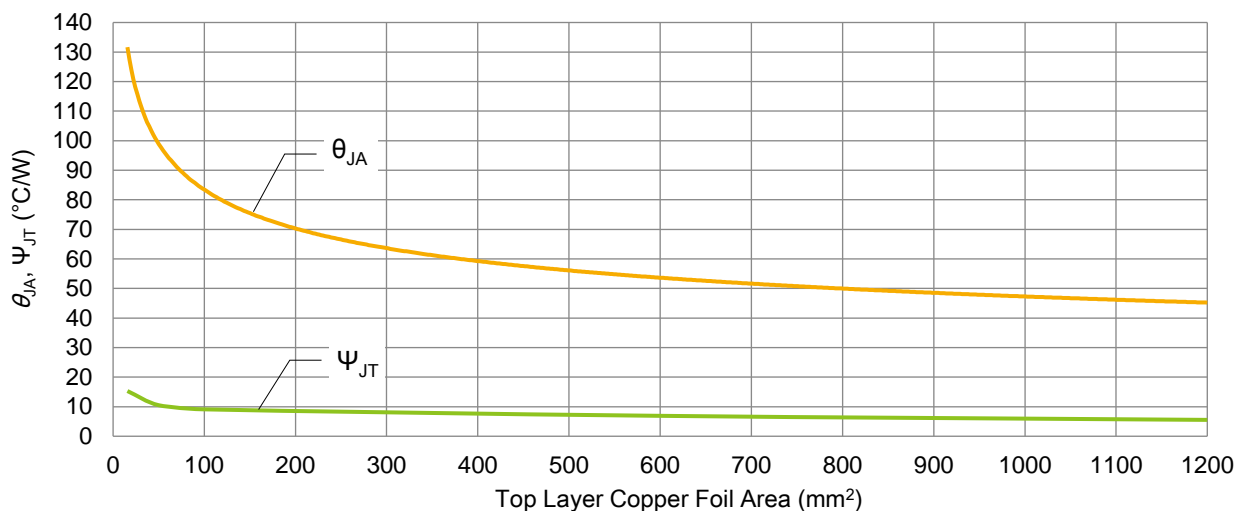

Figure 3-1-1-1. θ_{JA} , ψ_{JT} vs. copper foil area



Figure 3-1-1-2. 1-layer board sectional view

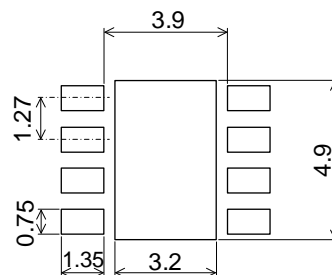

Figure 3-1-1-3. Footprint dimensions

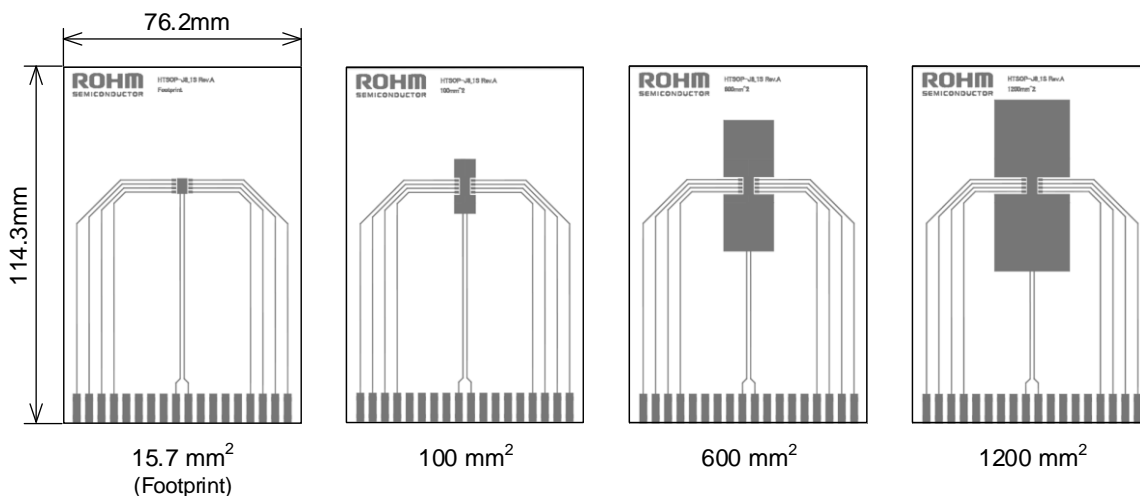

Figure 3-1-1-4. Top layer

3-1. Change in copper foil area (continued)

3-1-2. 2 layers

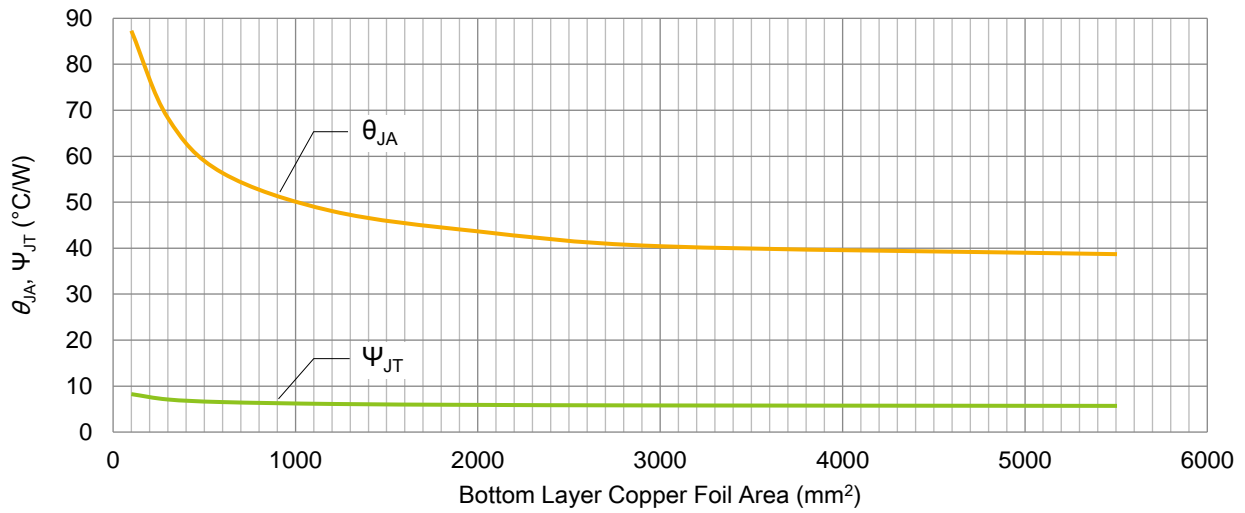

Figure 3-1-2-1. θ_{JA} , ψ_{JT} vs. copper foil area

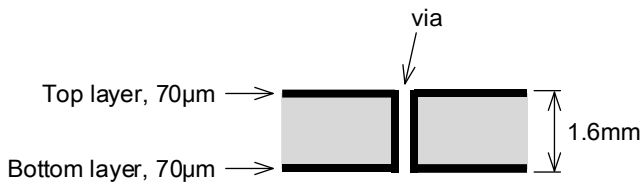

Figure 3-1-2-2. 2-layer board sectional view

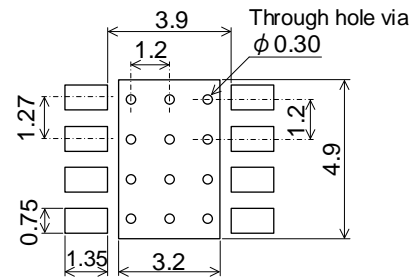

Figure 3-1-2-3. Footprint dimensions

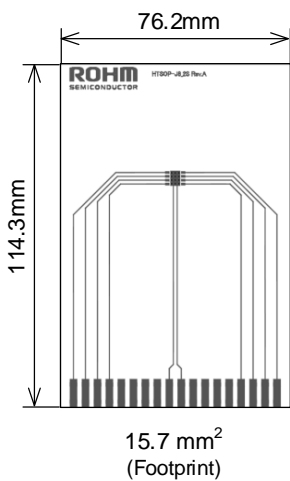

Figure 3-1-2-4. Top layer

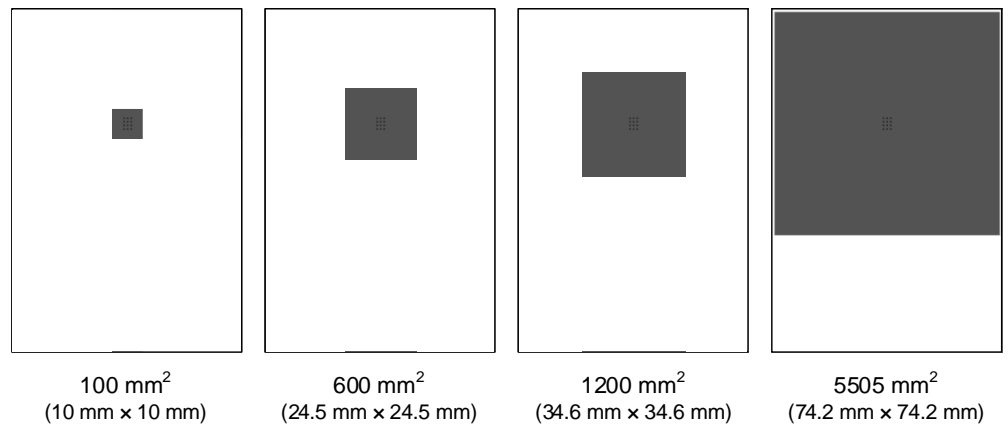

Figure 3-1-2-5. Bottom layer

3-1. Change in copper foil area (continued)

3-1-3. 4 layers, change in copper foil area of multiple layers

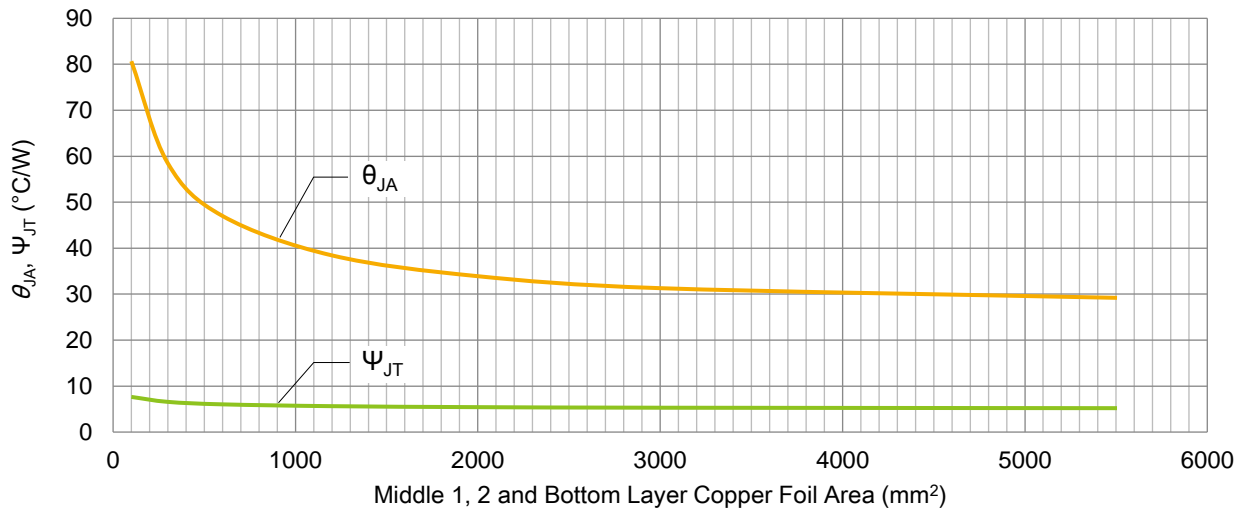

Figure 3-1-3-1. θ_{JA} , Ψ_{JT} vs. copper foil area

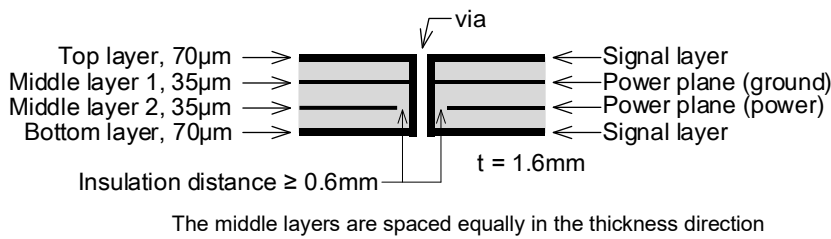

Figure 3-1-3-2. 4-layer board sectional view

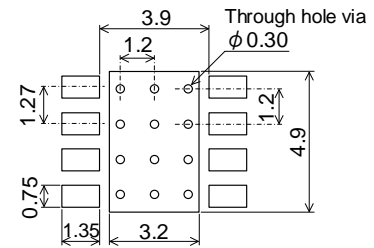

Figure 3-1-3-3. Footprint dimensions

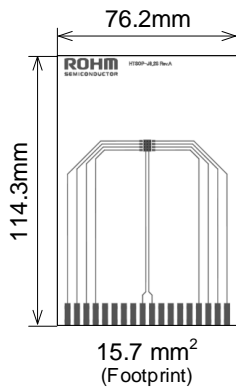

Figure 3-1-3-4. Top layer

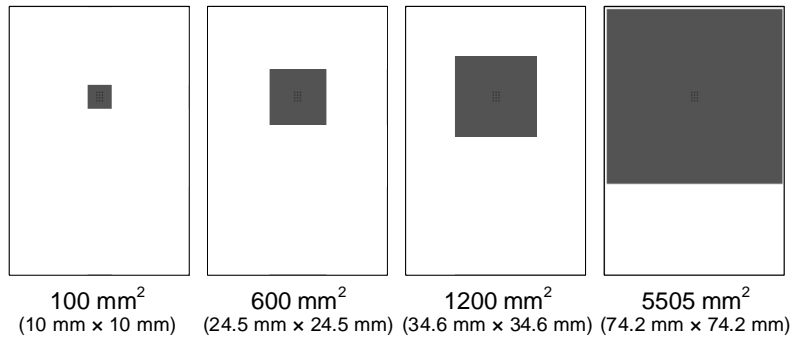

Figure 3-1-3-5. Middle layer 1, Bottom layer

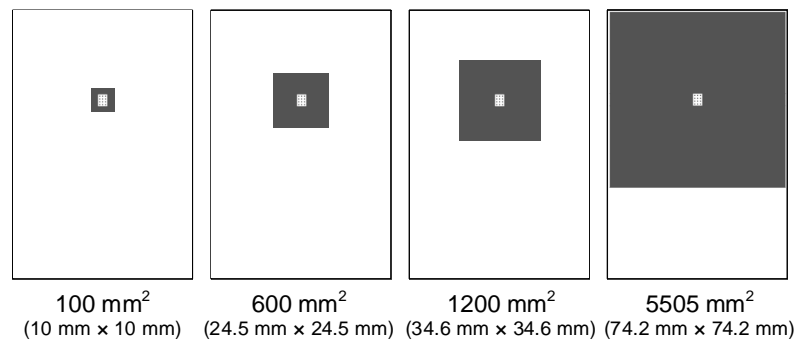

Figure 3-1-3-6. Middle layer 2

3-1. Change in copper foil area (continued)

3-1-4. 4 layers, change in copper foil area of bottom layer only

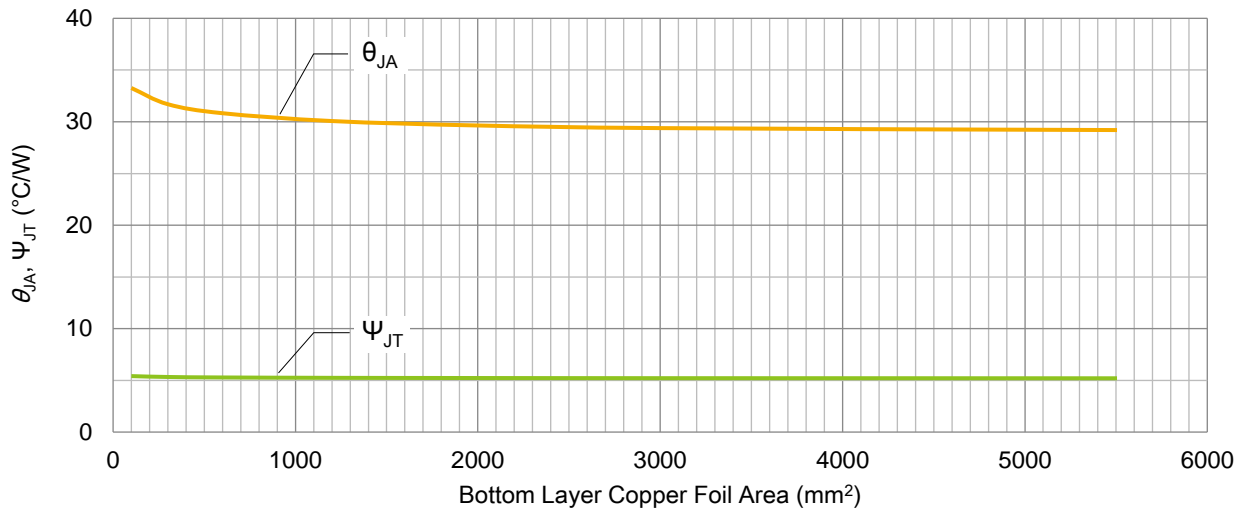
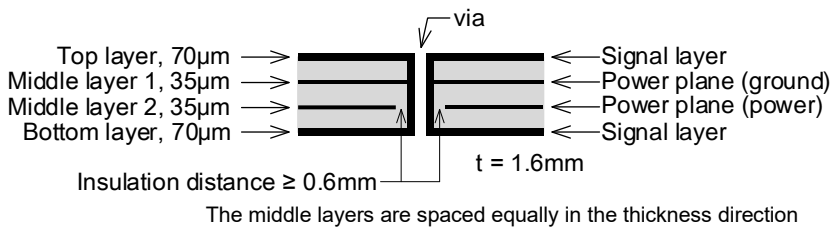

Figure 3-1-4-1. θ_{JA} , ψ_{JT} vs. copper foil area



The middle layers are spaced equally in the thickness direction

Figure 3-1-4-2. 4-layer board sectional view

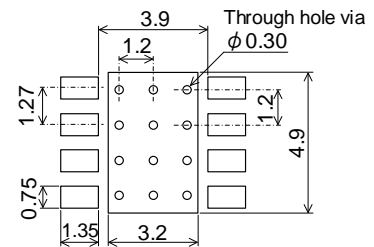

Figure 3-1-4-3. Footprint dimensions

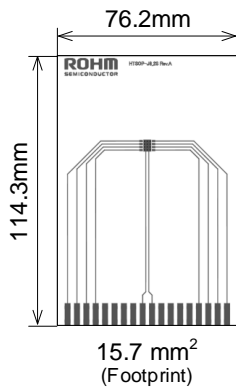

Figure 3-1-4-4. Top layer

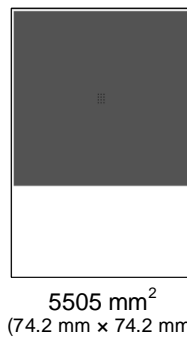

Figure 3-1-4-5. Middle layer 1

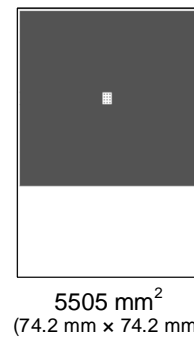

Figure 3-1-4-6. Middle layer 2

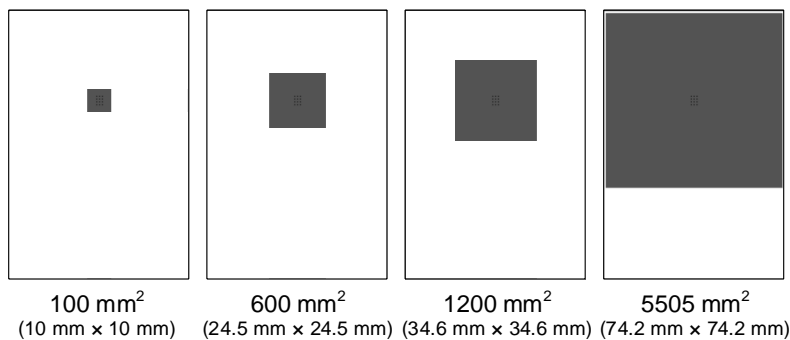

Figure 3-1-4-7. Bottom layer

3-1. Change in copper foil area (continued)

3-1-5. 6 layers, change in copper foil area of multiple layers

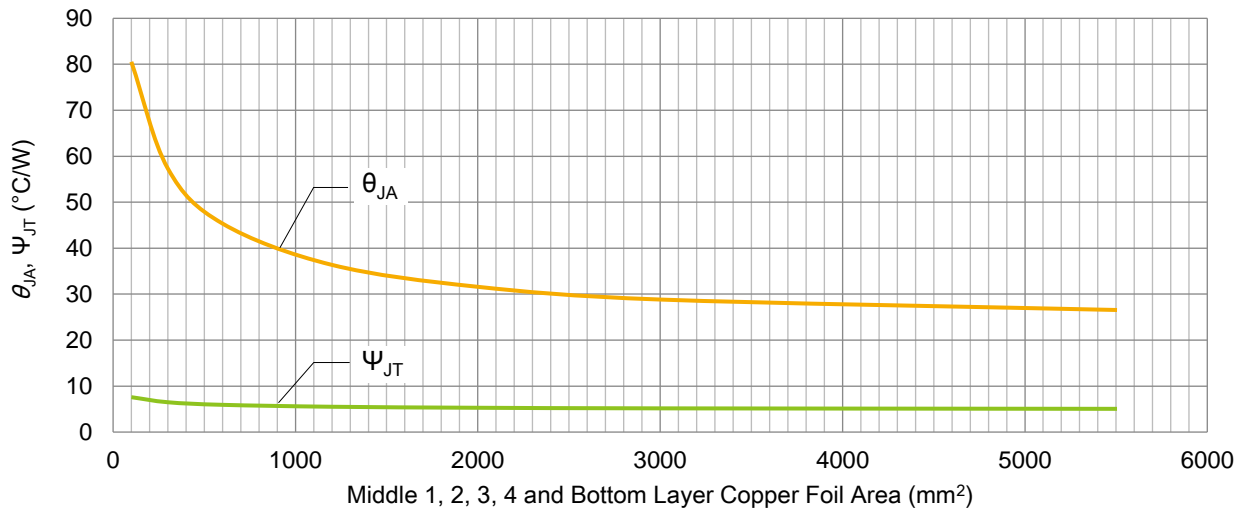

Figure 3-1-5-1. θ_{JA} , ψ_{JT} vs. copper foil area

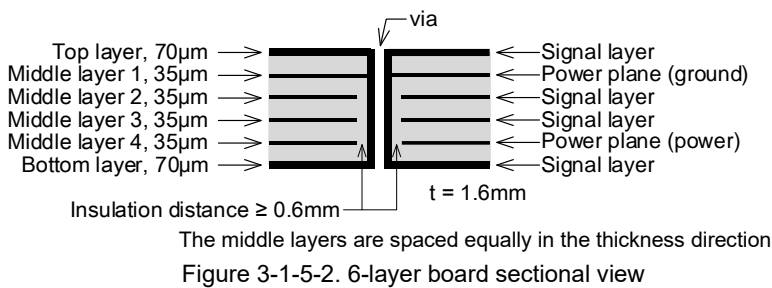

Figure 3-1-5-2. 6-layer board sectional view

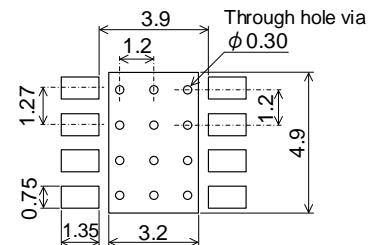

Figure 3-1-5-3. Footprint dimensions

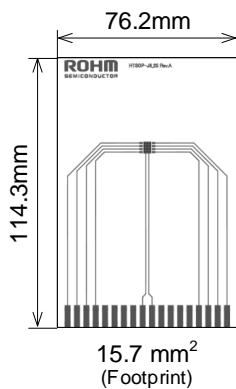

Figure 3-1-5-4. Top layer

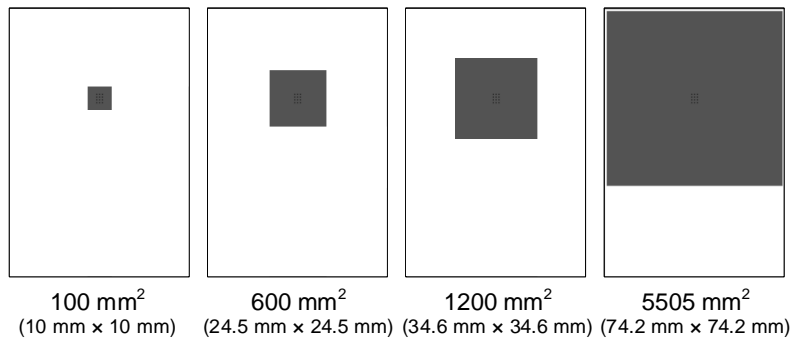

Figure 3-1-5-5. Middle layer 1, Bottom layer

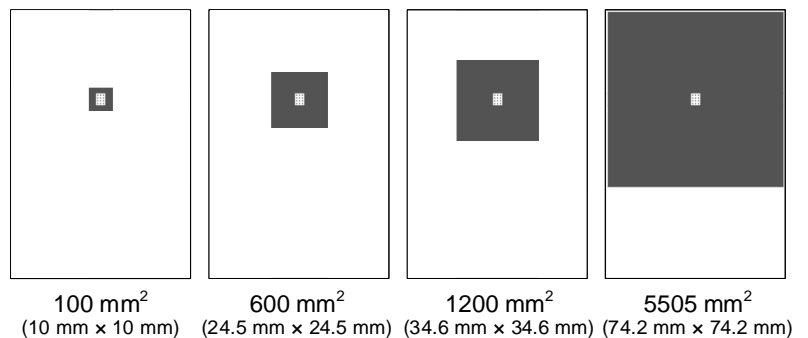

Figure 3-1-5-6. Middle layer 2, 3, 4

3-1. Change in copper foil area (continued)

3-1-6. 6 layers, change in copper foil area of bottom layer only

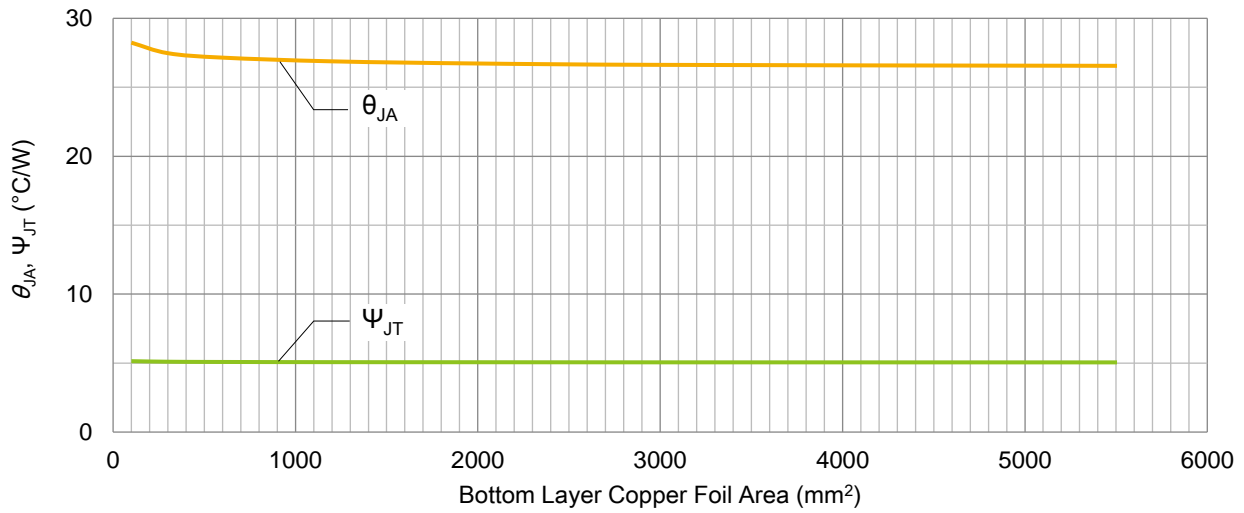
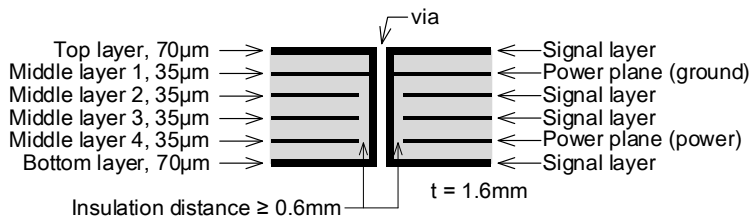

Figure 3-1-6-1. θ_{JA} , ψ_{JT} vs. copper foil area



The middle layers are spaced equally in the thickness direction

Figure 3-1-6-2. 6-layer board sectional view

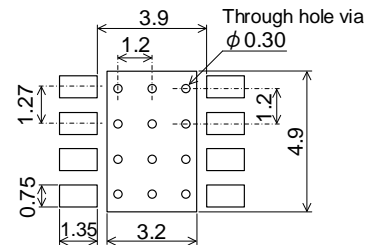

Figure 3-1-6-3. Footprint dimensions

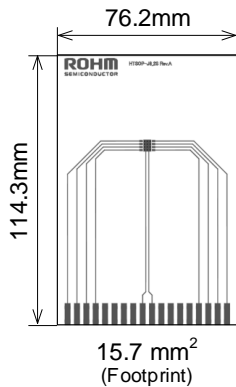

Figure 3-1-6-4. Top layer

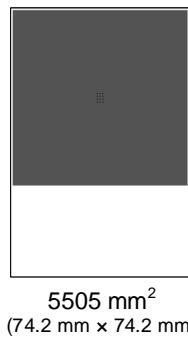

Figure 3-1-6-5. Middle layer 1

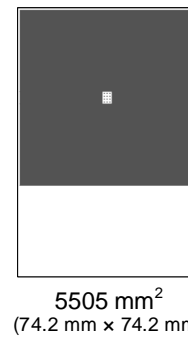

Figure 3-1-6-6. Middle layer 2, 3, 4

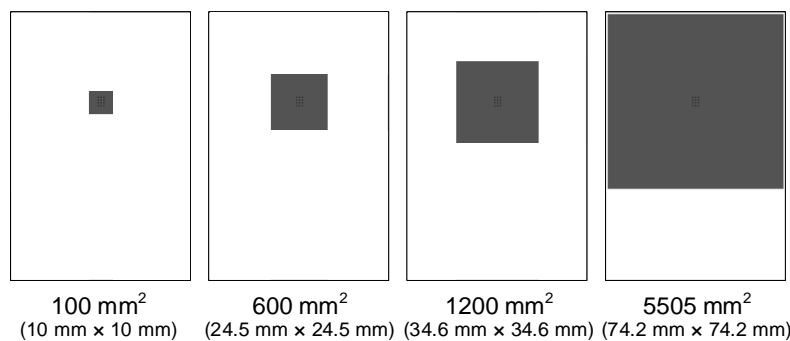

Figure 3-1-4-7. Bottom layer

3-1. Change in copper foil area (continued)

3-1-7. 8 layers, change in copper foil area of multiple layers

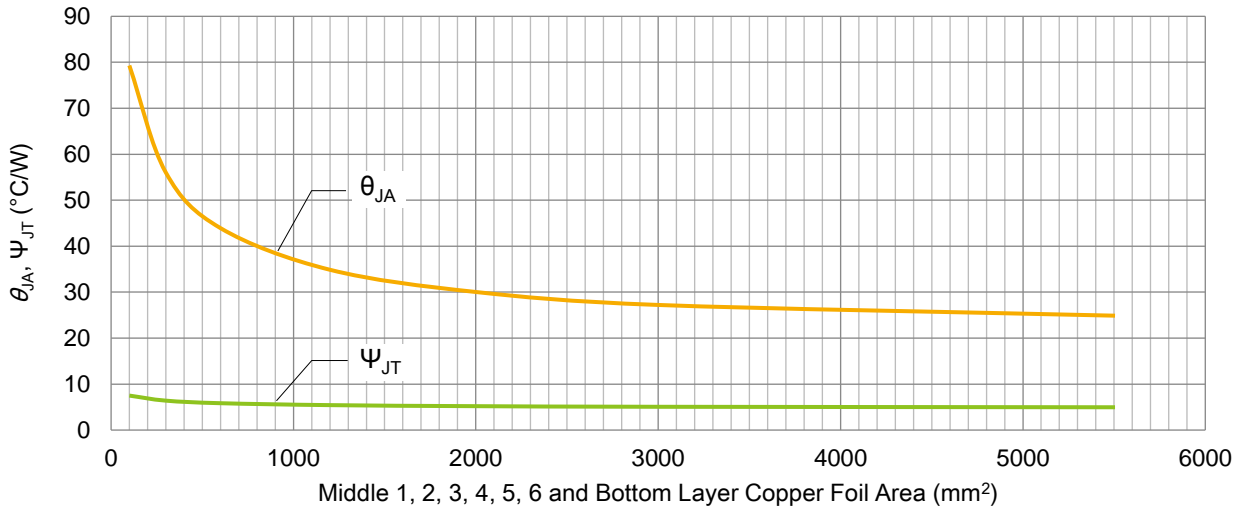
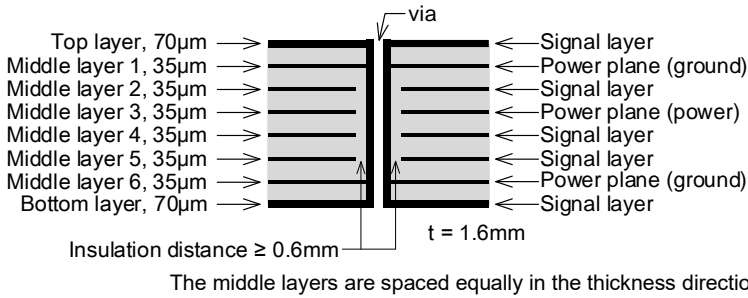

Figure 3-1-7-1. θ_{JA} , Ψ_{JT} vs. copper foil area



The middle layers are spaced equally in the thickness direction
Figure 3-1-7-2. 8-layer board sectional view

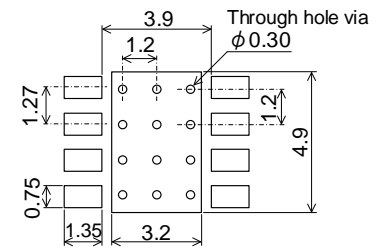

Figure 3-1-7-3. Footprint dimensions

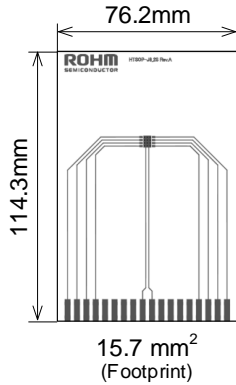

Figure 3-1-7-4. Top layer

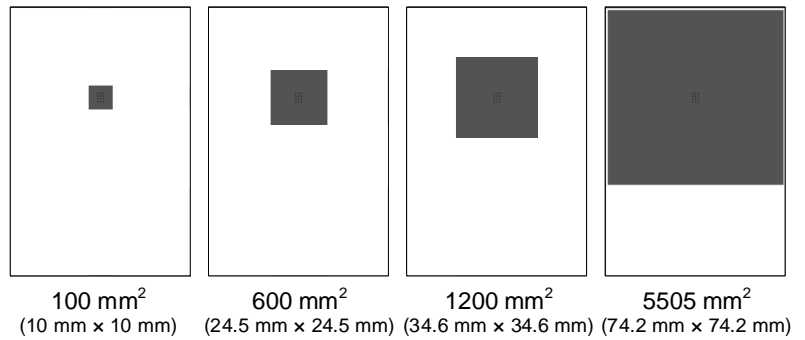

Figure 3-1-7-5. Middle layer 1, 6, Bottom layer

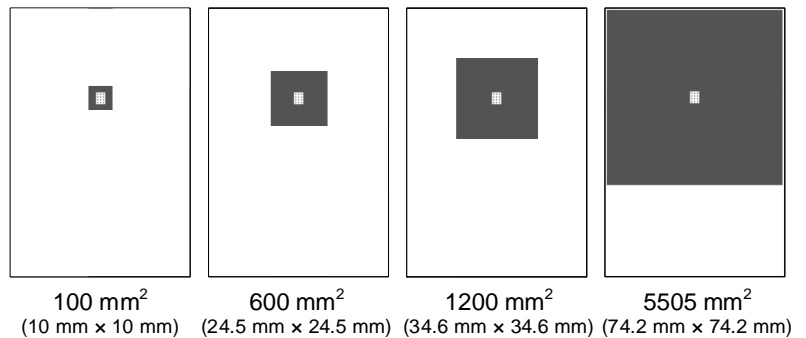

Figure 3-1-7-6. Middle layer 2, 3, 4, 5

3-1. Change in copper foil area (continued)

3-1-8. 8 layers, change in copper foil area of bottom layer only

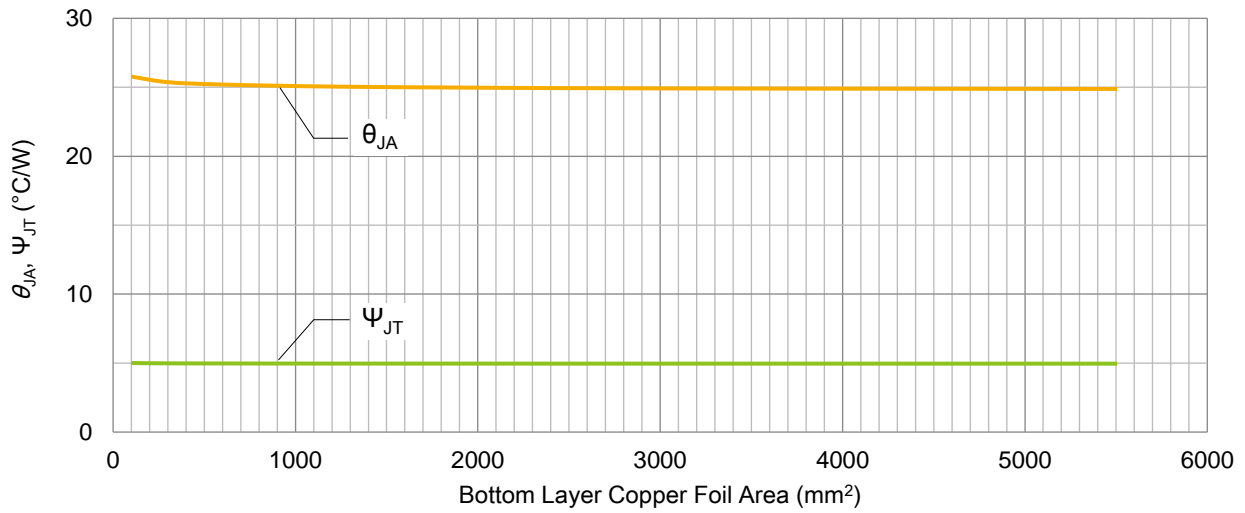

Figure 3-1-8-1. θ_{JA} , ψ_{JT} vs. copper foil area

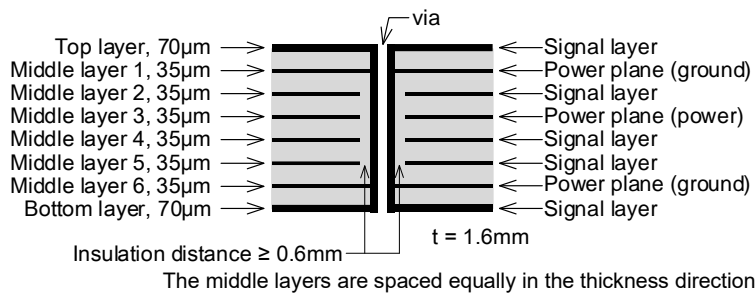

Figure 3-1-8-2. 8-layer board sectional view

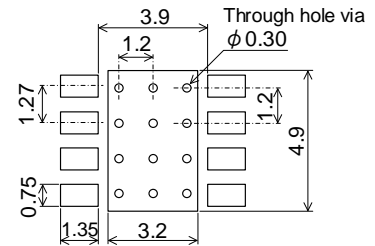
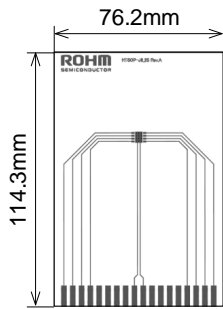
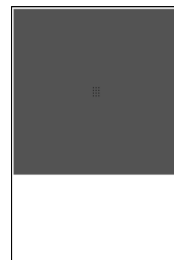

Figure 3-1-8-3. Footprint dimensions



15.7 mm²
(Footprint)

Figure 3-1-8-4. Top layer



5505 mm²
(74.2 mm x 74.2 mm)

Figure 3-1-8-5. Middle layer 1, 6

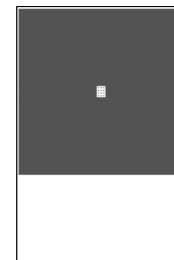

5505 mm²
(74.2 mm x 74.2 mm)

Figure 3-1-8-6. Middle layer 2, 3, 4, 5

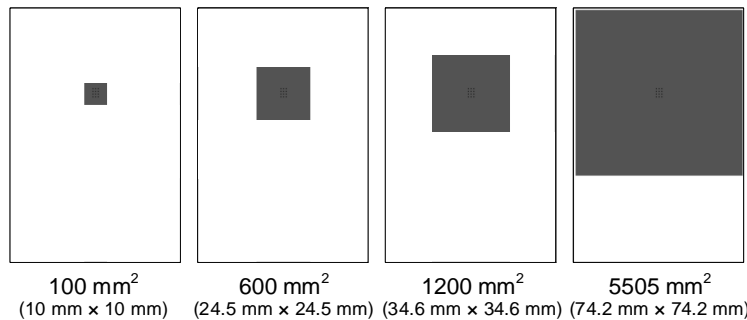

Figure 3-1-8-7. Bottom layer

3-2. Change in copper foil thickness

3-2-1. 1 layer

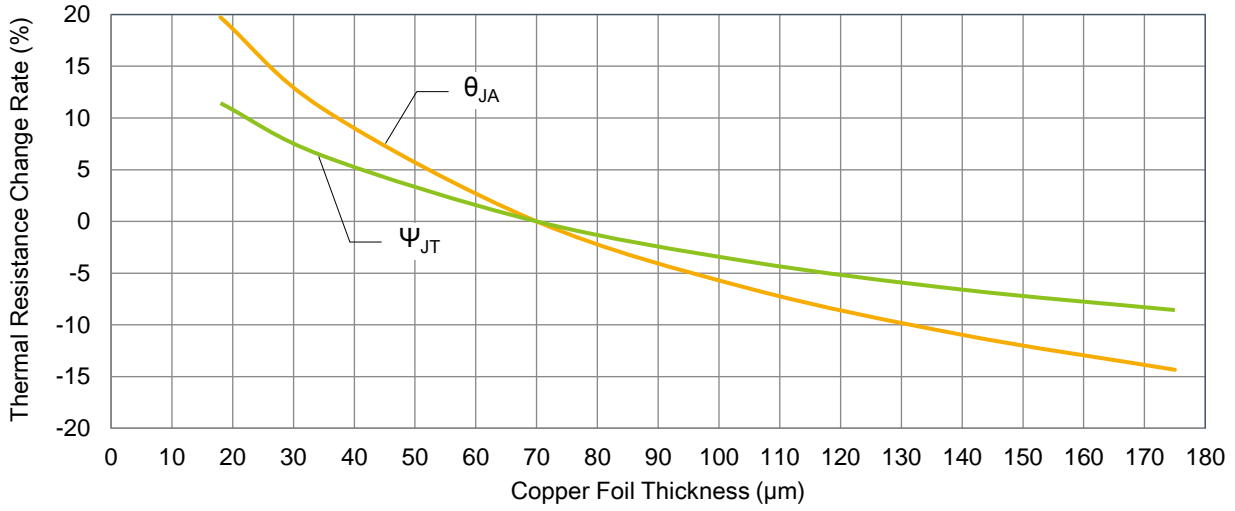

Figure 3-2-1-1. Variation rates of θ_{JA} and ψ_{JT} vs. copper foil thickness

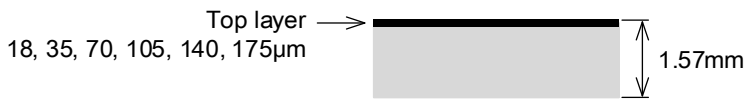

Figure 3-2-1-2. 1-layer board sectional view

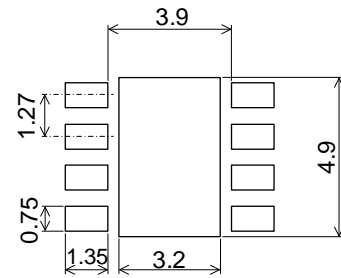

Figure 3-2-1-3. Footprint dimensions

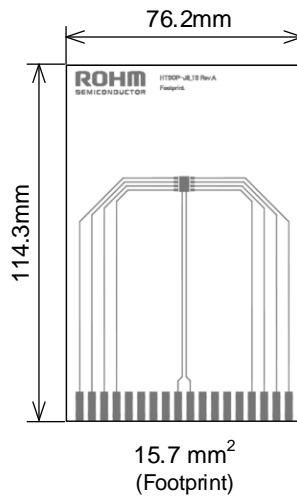

Figure 3-2-1-4. Top layer

3-2. Change in copper foil thickness (continued)

3-2-2. 2 layers

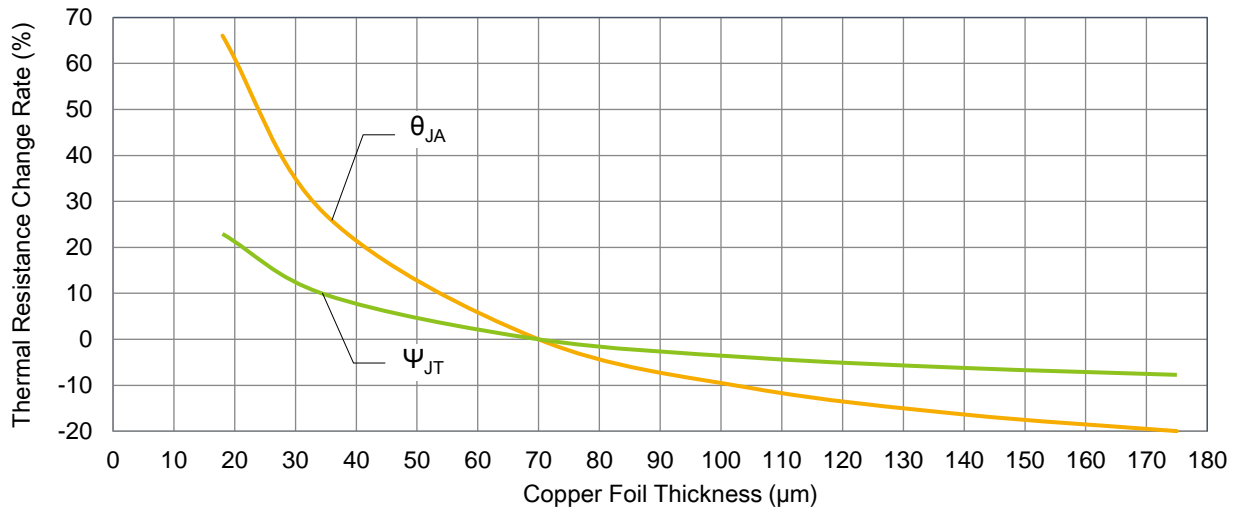

Figure 3-2-2-1. Variation rates of θ_{JA} and Ψ_{JT} vs. copper foil thickness

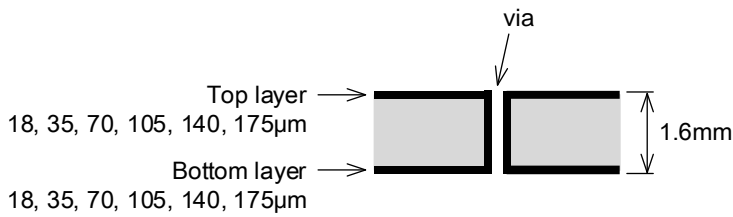

Figure 3-2-2-2. 2-layer board sectional view

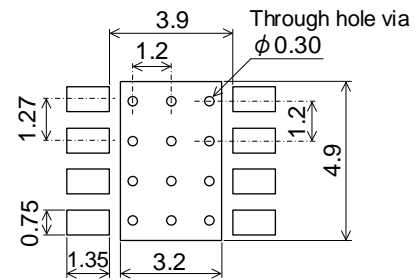

Figure 3-2-2-3. Footprint dimensions

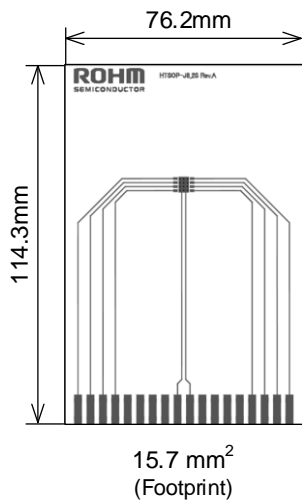

Figure 3-2-2-4. Top layer

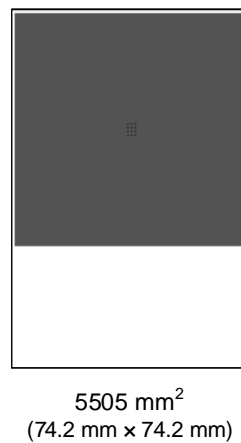

Figure 3-2-2-5. Bottom layer

3-2. Change in copper foil thickness (continued)

3-2-3. 4 layers

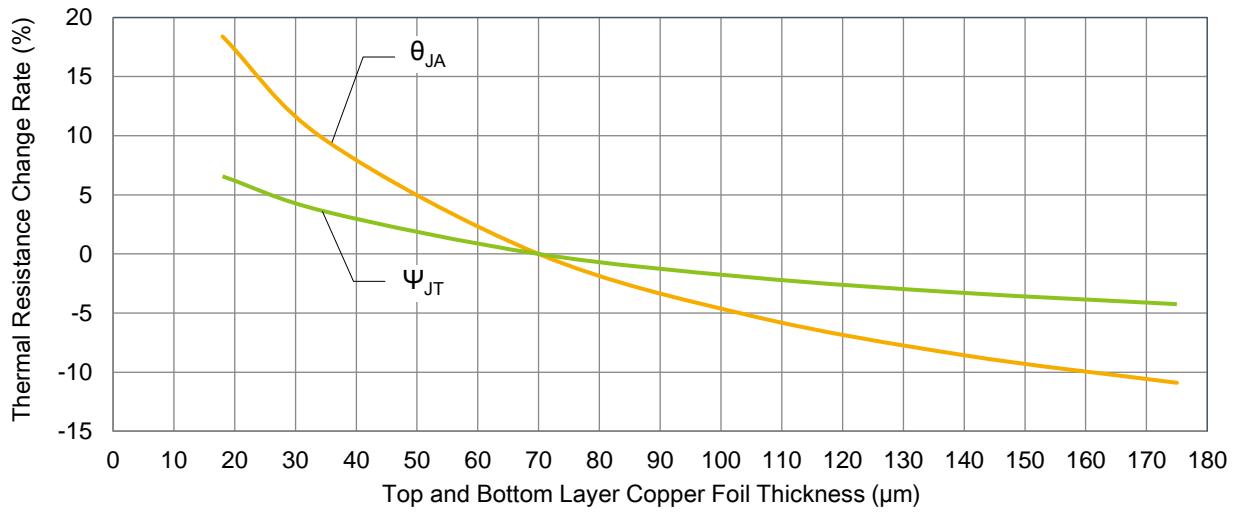

Figure 3-2-3-1. Variation rates of θ_{JA} and Ψ_{JT} vs. copper foil thickness

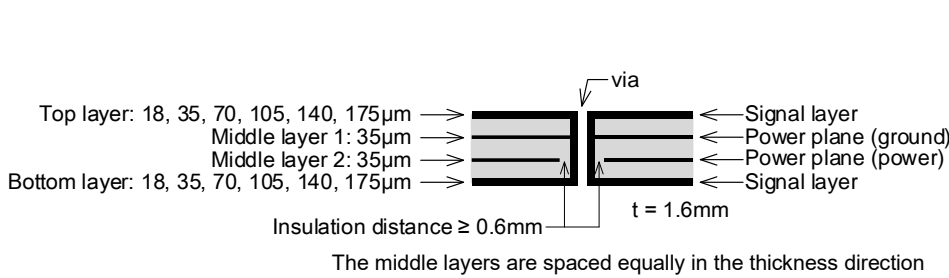

Figure 3-2-3-2. 4-layer board sectional view

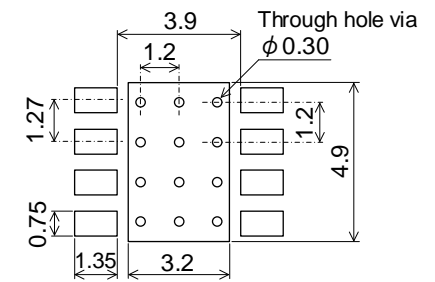

Figure 3-2-3-3. Footprint dimensions

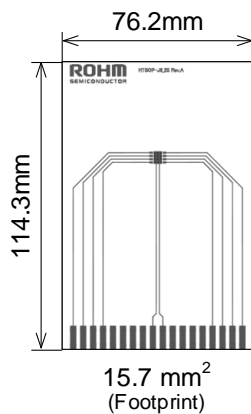

Figure 3-2-3-4. Top layer

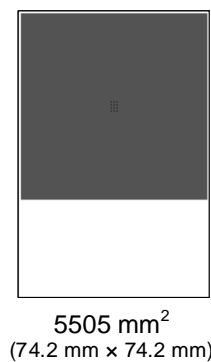

Figure 3-2-3-5. Middle layer 1

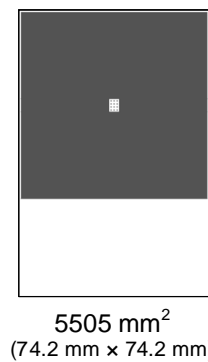

Figure 3-2-3-6. Middle layer 2

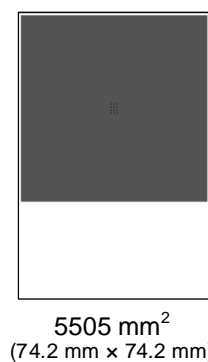

Figure 3-2-3-7. Bottom layer

3-3. Thermal via configuration

3-3-1. 2 layers

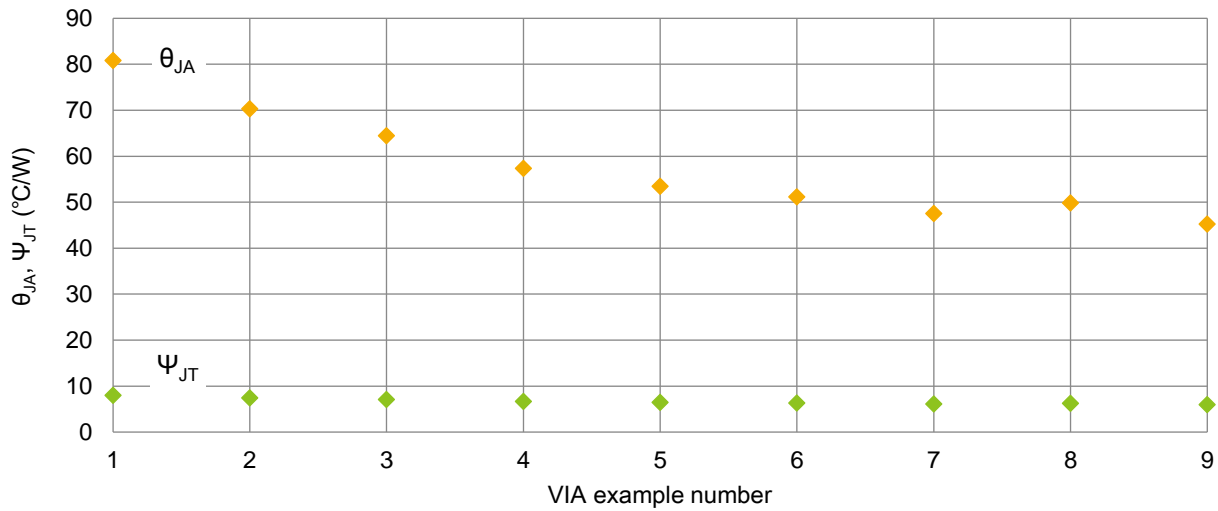

Figure 3-3-1-1. θ_{JA} , ψ_{JT} vs. thermal via configuration

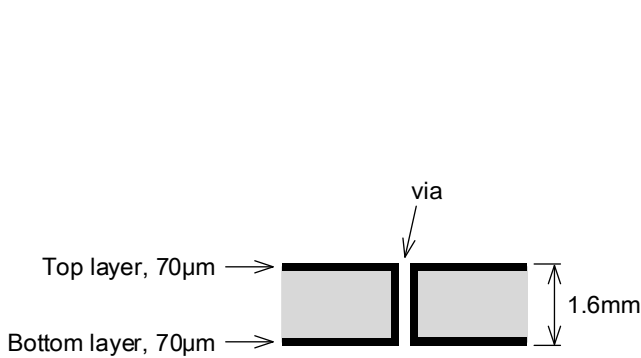

Figure 3-3-1-2. 2-layer board sectional view

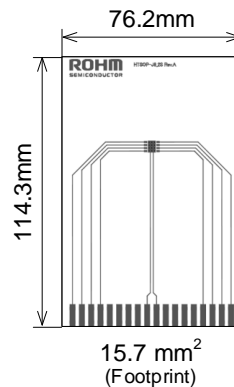

Figure 3-3-1-3. Top layer

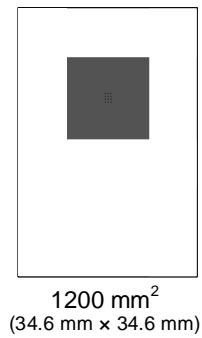
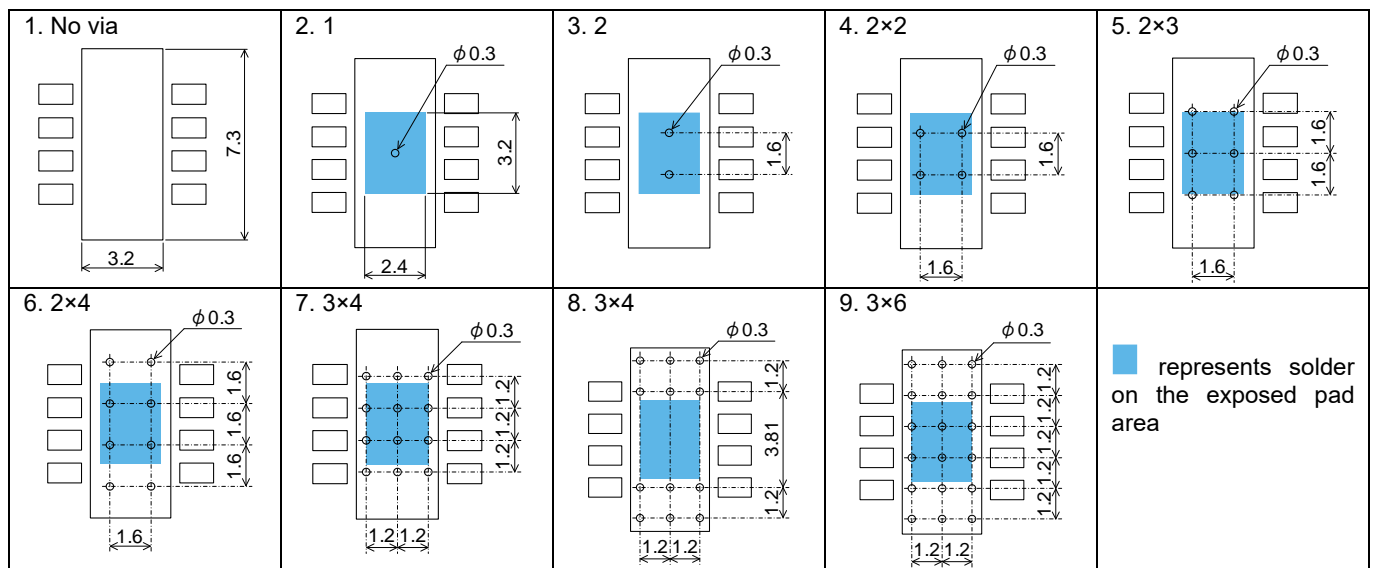

Figure 3-3-1-4. Bottom layer

Numbers for via examples



3-4. Change in board thickness

3-4-1. 1 layer

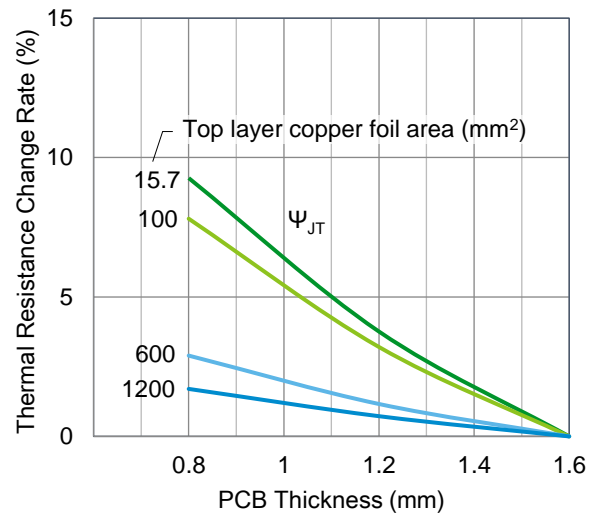
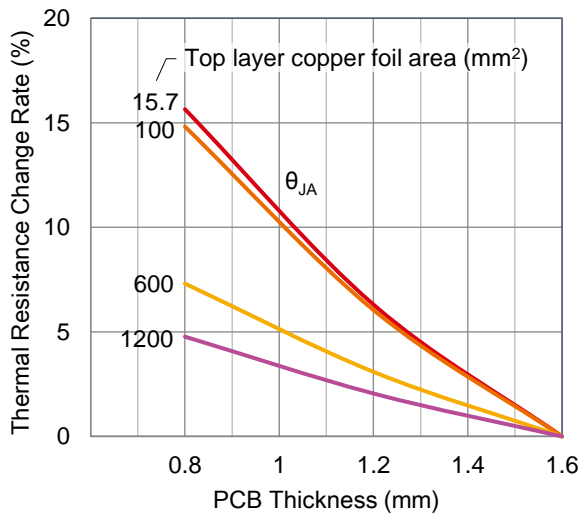

Figure 3-4-1-1. Variation rates of θ_{JA} and Ψ_{JT} vs. board thickness



Figure 3-4-1-2. 1-layer board sectional view

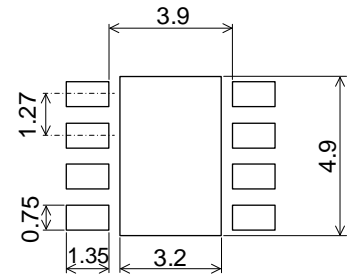

Figure 3-4-1-3. Footprint dimensions

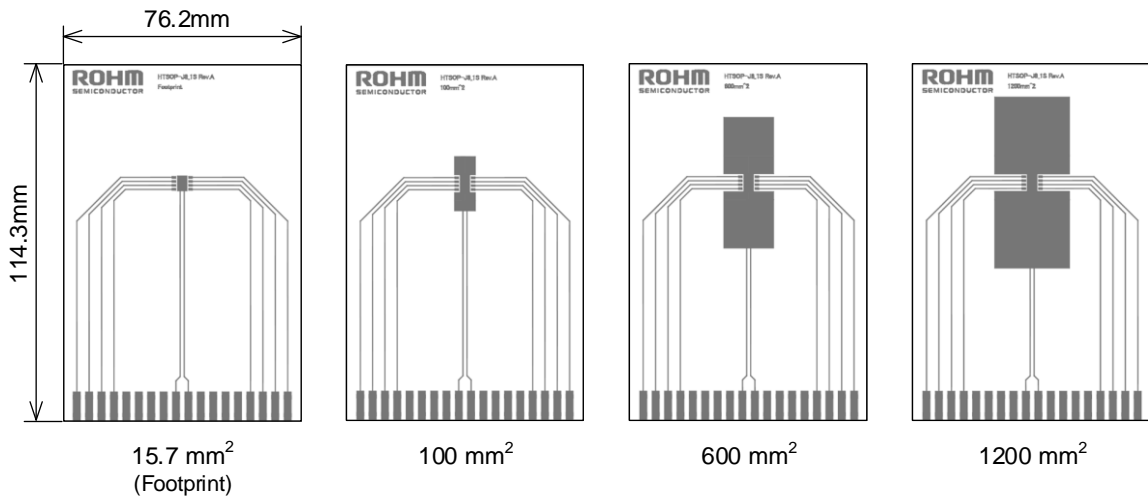

Figure 3-4-1-4. Top layer

3-4. Change in board thickness (continued)

3-4-2. 2 layers

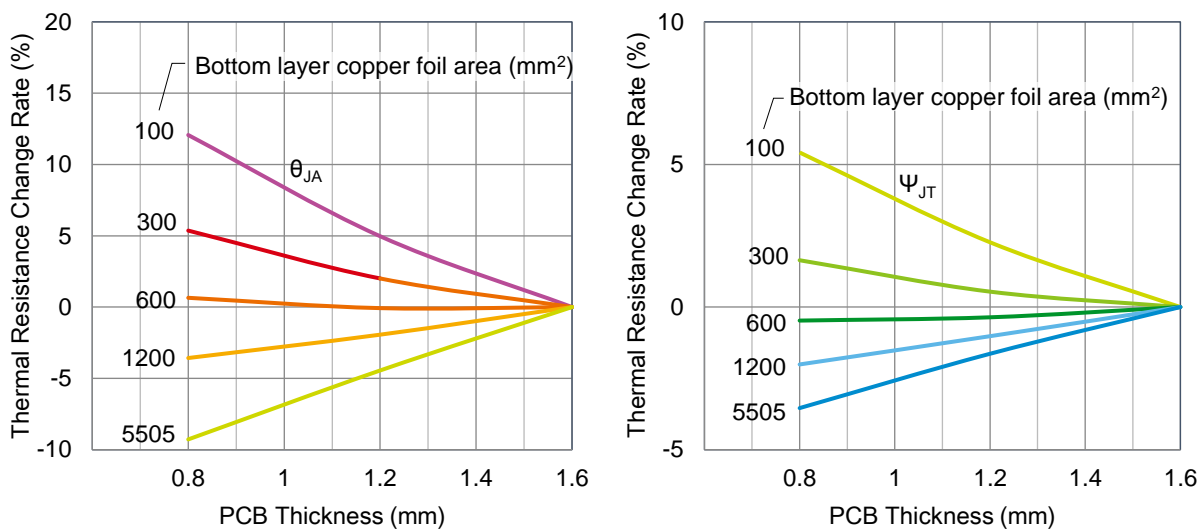

Figure 3-4-2-1. Variation rates of θ_{JA} and Ψ_{JT} vs. board thickness

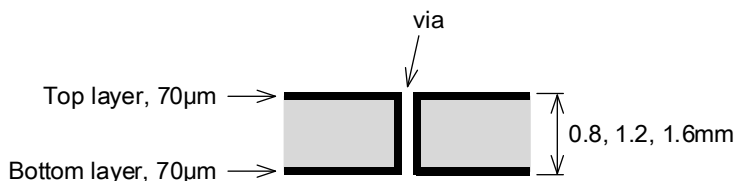

Figure 3-4-2-2. 2-layer board sectional view

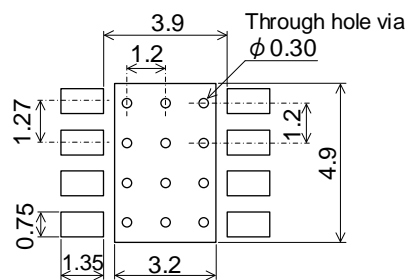

Figure 3-4-2-3. Footprint dimensions

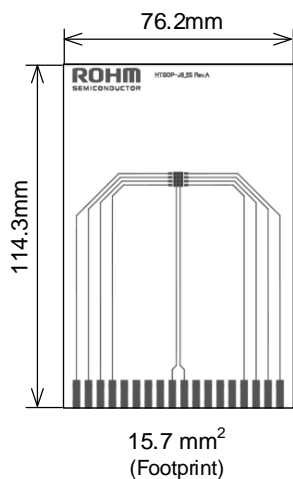

Figure 3-4-2-4. Top layer

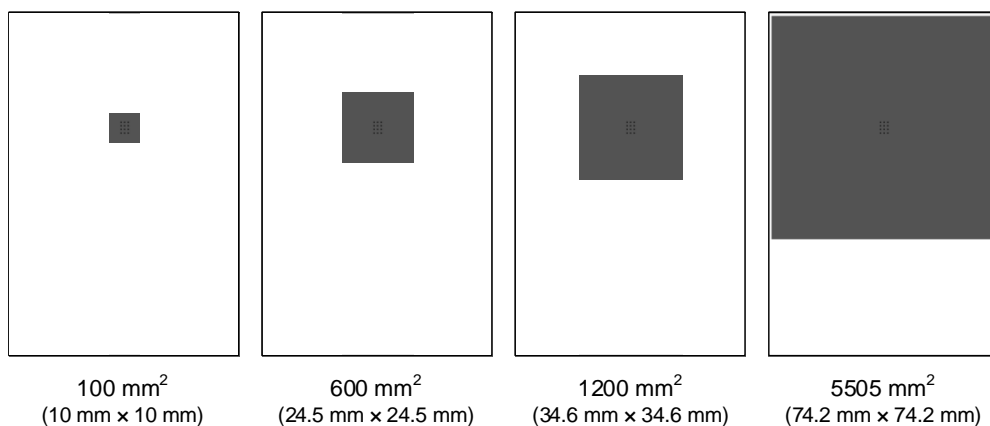

Figure 3-4-2-5. Bottom layer

3-4. Change in board thickness (continued)

3-4-3. 4 layers

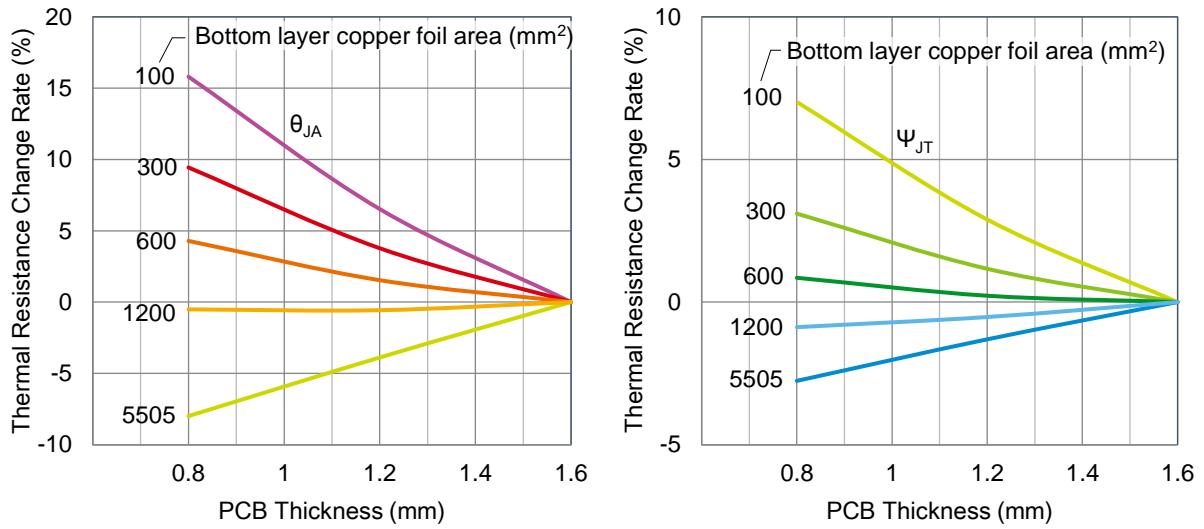

Figure 3-4-3-1. Variation rates of θ_{JA} and ψ_{JT} vs. board thickness

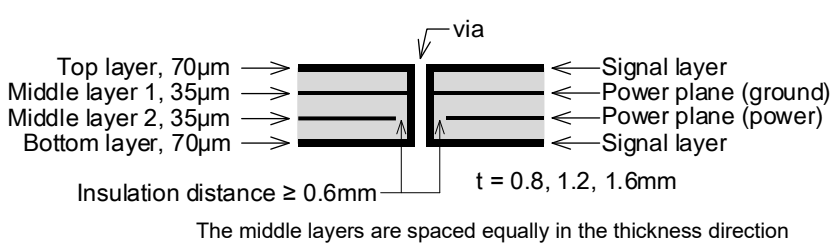

Figure 3-4-3-2. 4-layer board sectional view

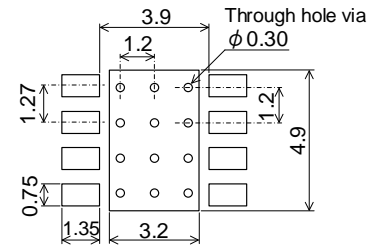

Figure 3-4-3-3. Footprint dimensions

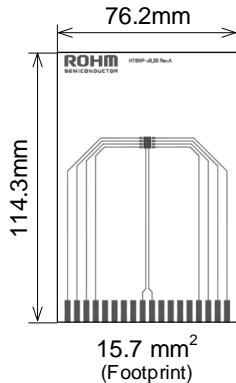

Figure 3-4-3-4. Top layer

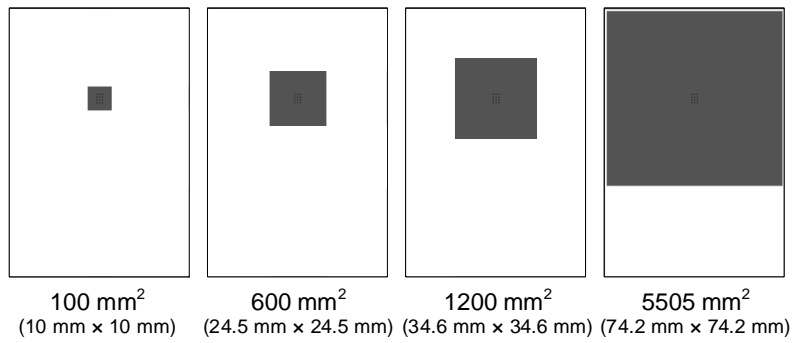

Figure 3-4-3-5. Middle layer 1, Bottom layer

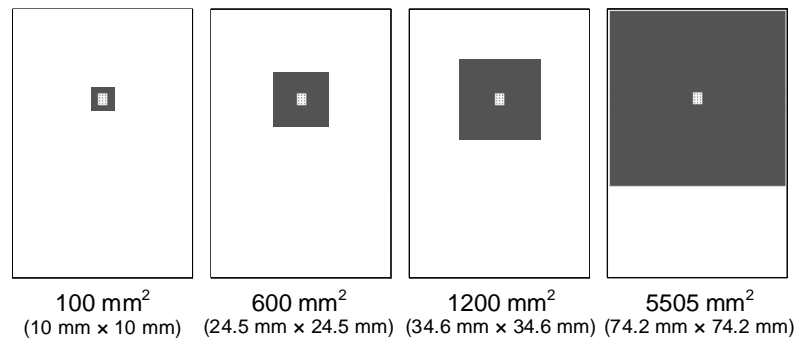
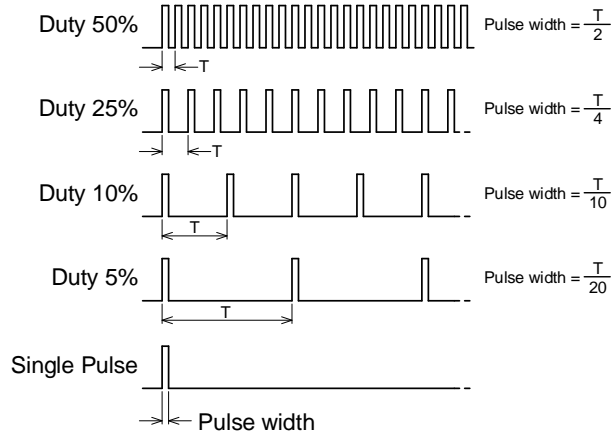

Figure 3-4-3-6. Middle layer 2

4. Transient thermal resistance

Graph axes descriptions

X-axis: The pulse width refers to the time during which the power is applied to a device



Y-axis: Transient thermal resistance

4-1. Transient thermal resistance, 1 layer



Figure 4-1-1. 1-layer board sectional view

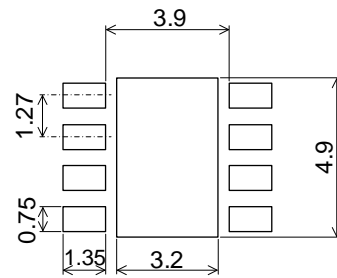

Figure 4-1-2. Footprint dimensions

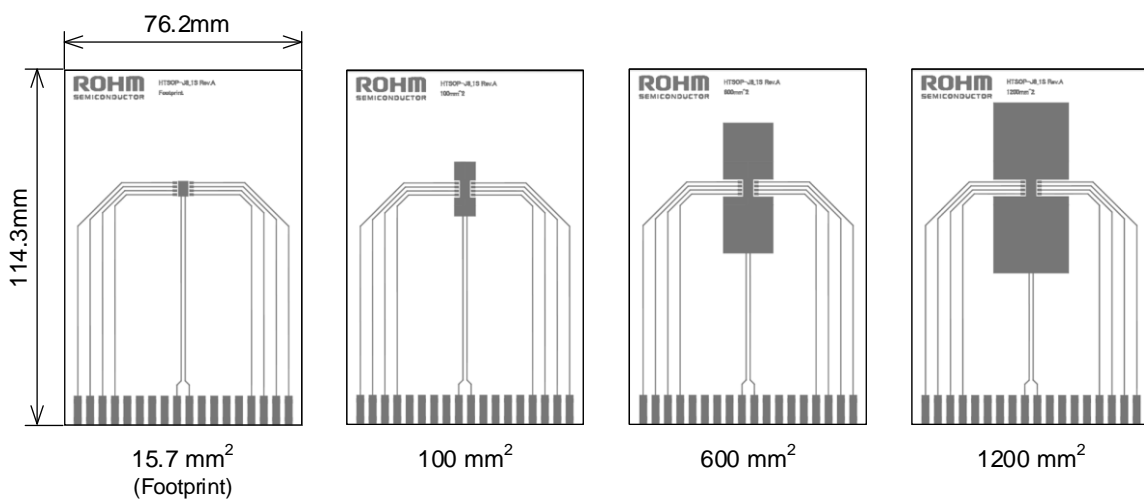

Figure 4-1-3. Top layer

4-1. Transient thermal resistance, 1 layer (continued)

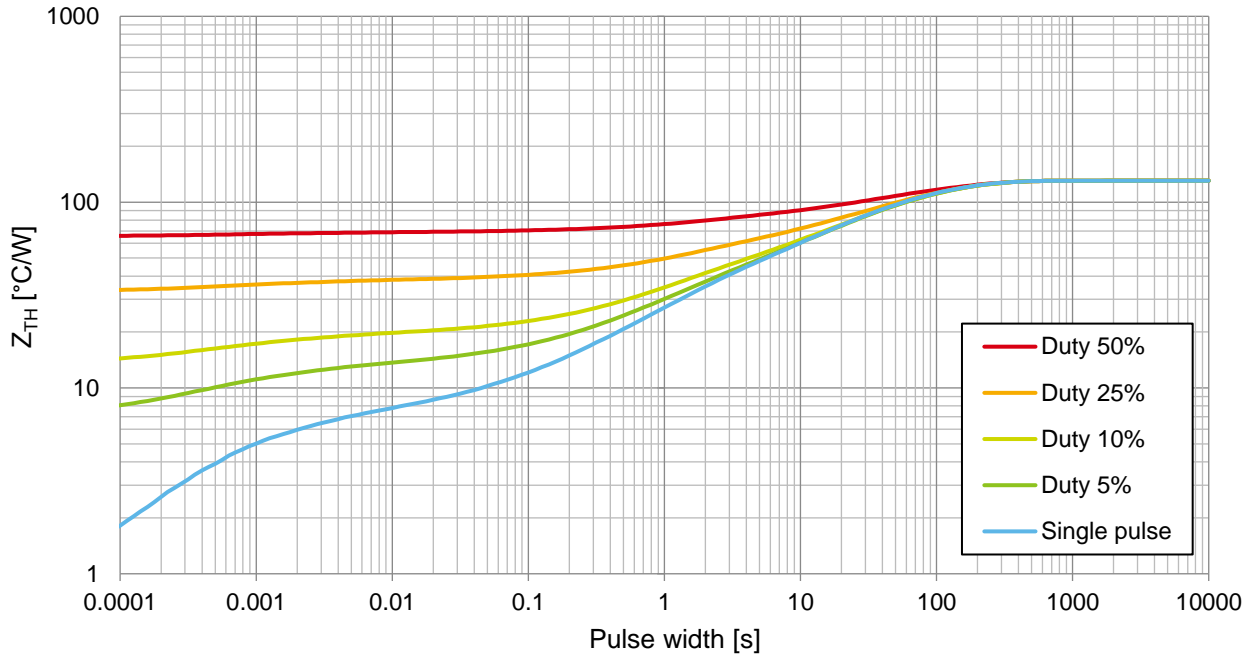

Figure 4-1-4. Transient thermal resistance, 1 layer
Copper foil area 15.7 mm² (Footprint)

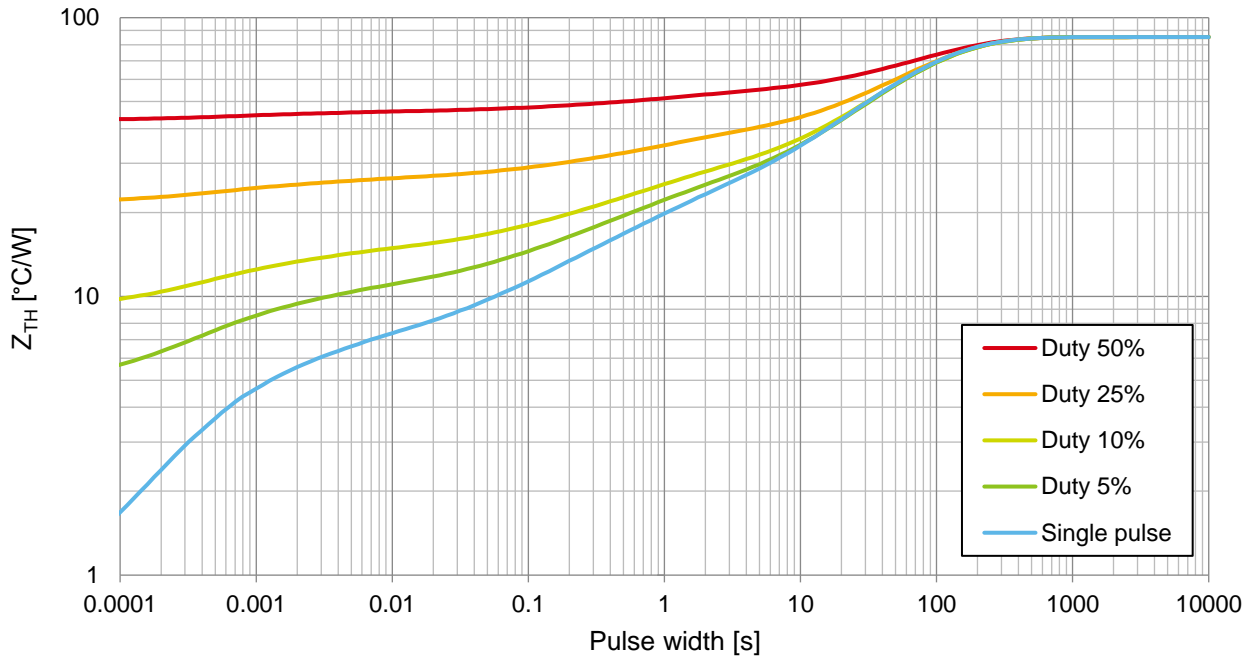

Figure 4-1-5. Transient thermal resistance, 1 layer
Copper foil area 100 mm²

4-1. Transient thermal resistance, 1 layer (continued)

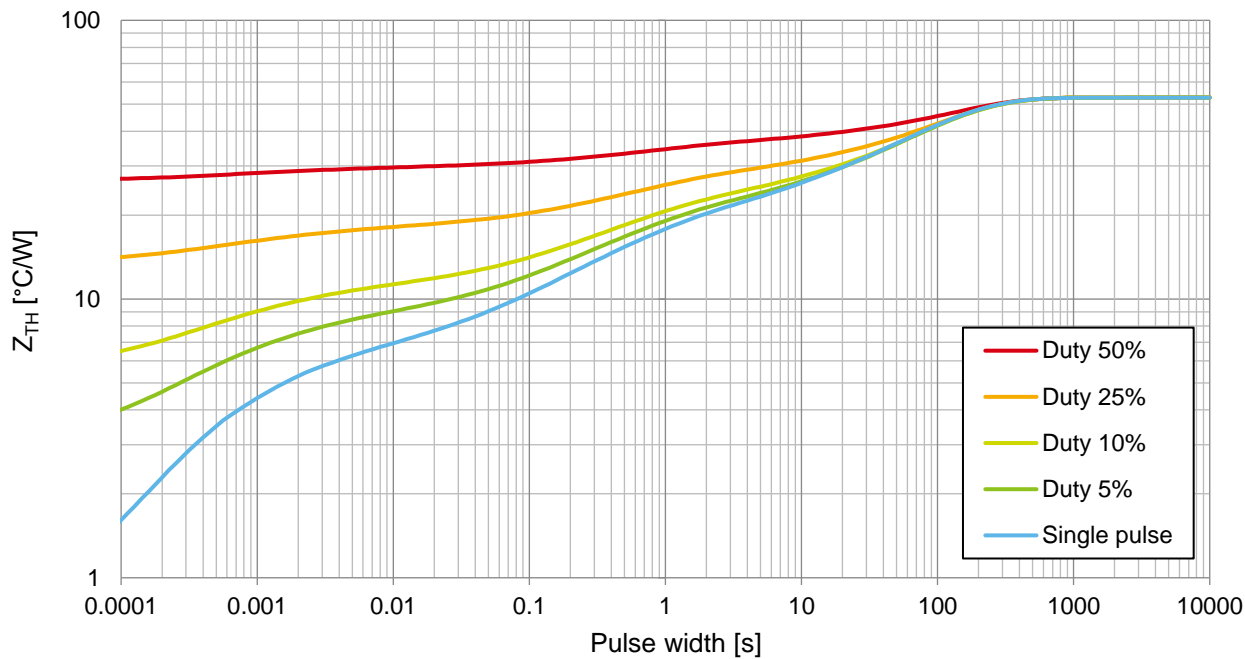

Figure 18. Transient thermal resistance, 1 layer
Copper foil area 600 mm²

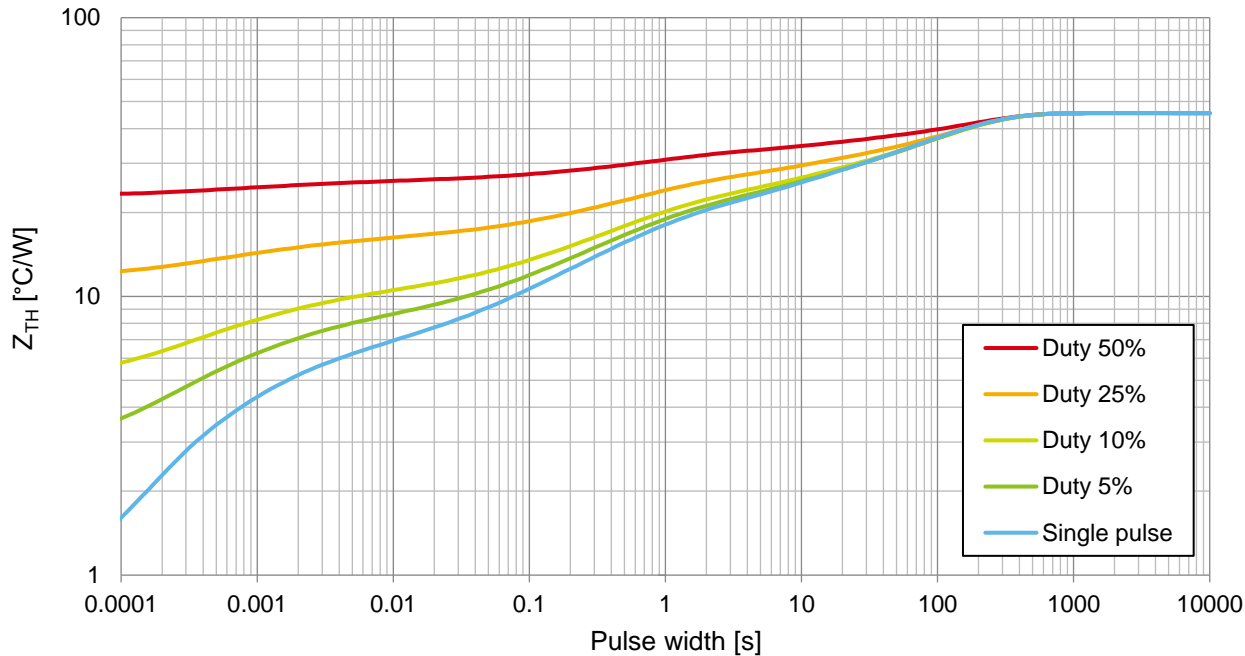

Figure 19. Transient thermal resistance, 1 layer
Copper foil area 1,200 mm²

4-2. Transient thermal resistance, 2 layers

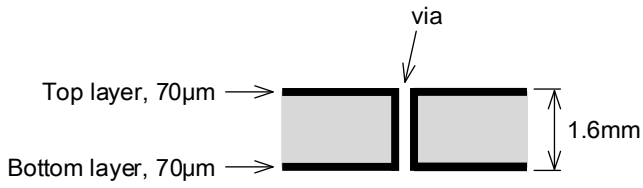

Figure 4-2-1. 2-layer board sectional view

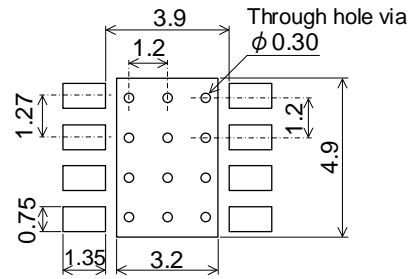

Figure 4-2-2. Footprint dimensions

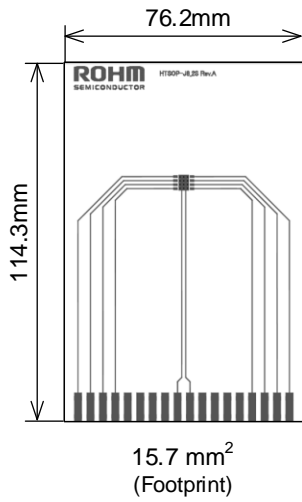

Figure 4-2-3. Top layer

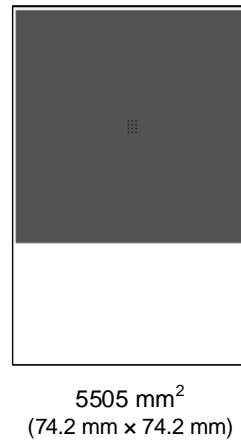

Figure 4-2-4. Bottom layer

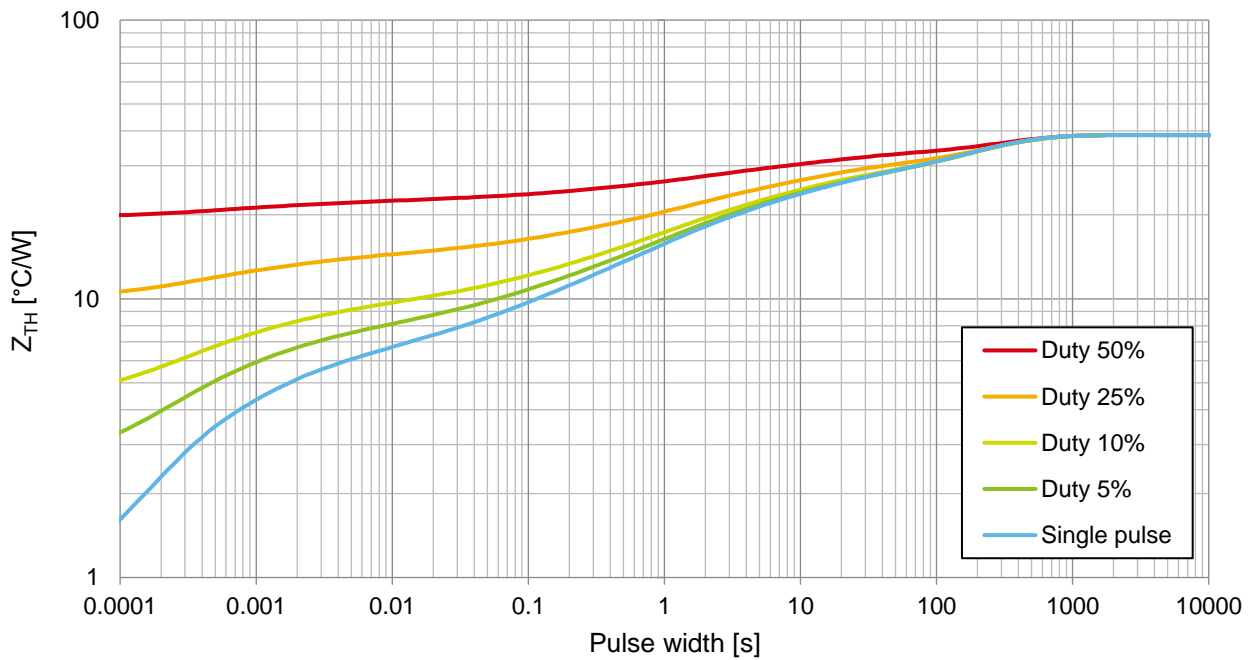

Figure 4-2-5. Transient thermal resistance, 2 layers

4-3. Transient thermal resistance, 4 layers

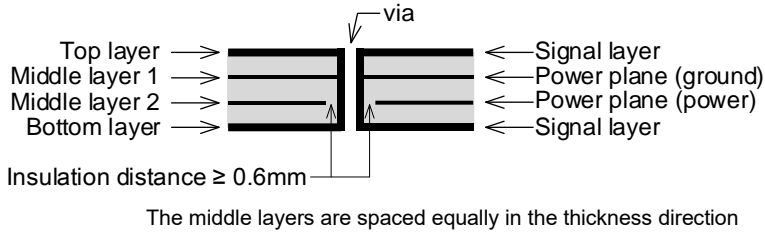

Figure 4-3-1. 4-layer board sectional view

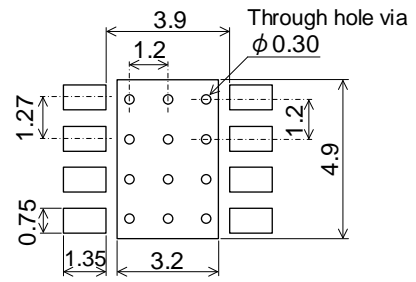

Figure 4-3-2. Footprint dimensions

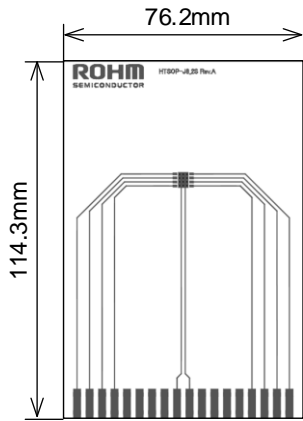

Figure 4-3-3. Top layer

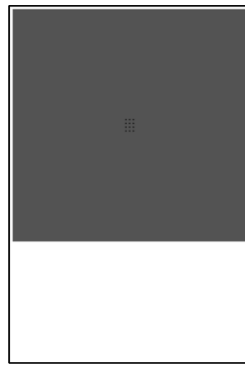

Figure 4-3-4. Middle 1 layer

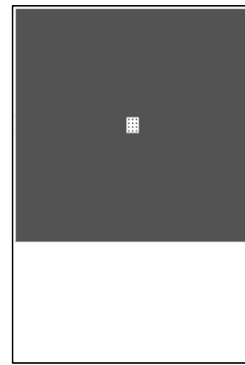

Figure 4-3-5. Middle 2 layer

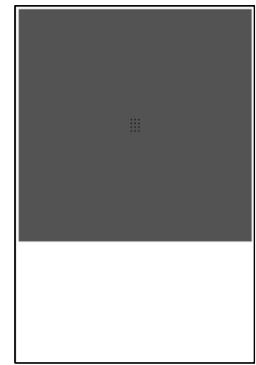

Figure 4-3-6. Bottom layer

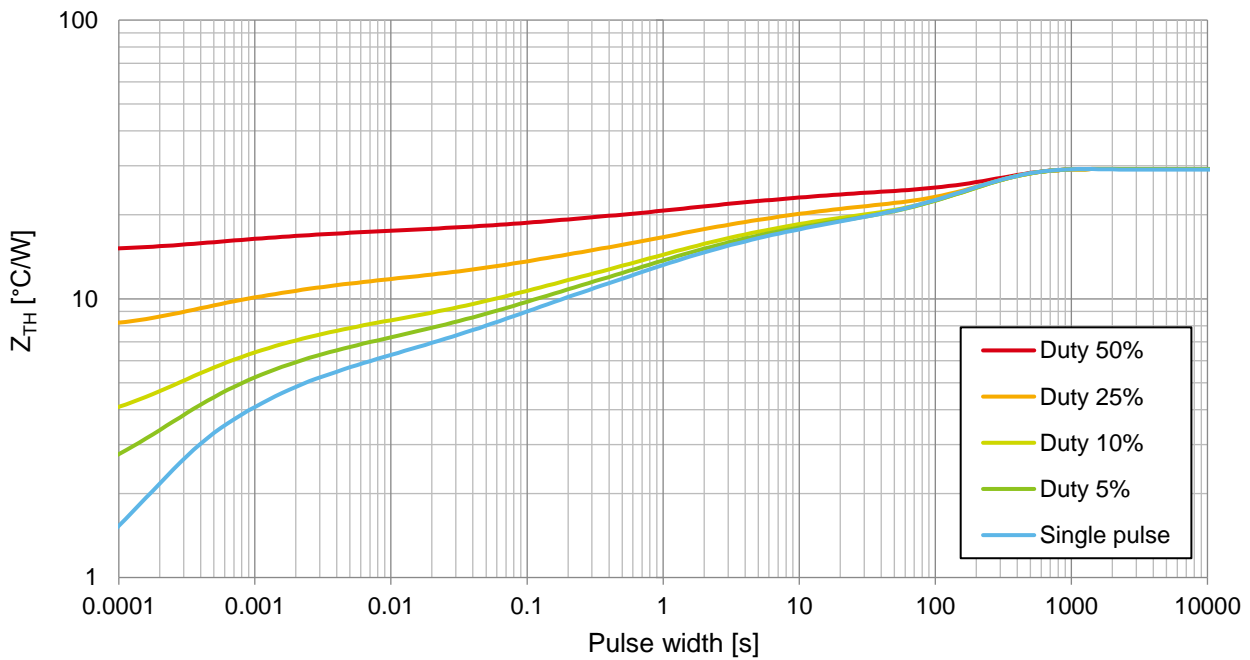

Figure 4-3-7. Transient thermal resistance, 4 layers

Notes

- 1) The information contained herein is subject to change without notice.
- 2) Before you use our Products, please contact our sales representative and verify the latest specifications :
- 3) Although ROHM is continuously working to improve product reliability and quality, semiconductors can break down and malfunction due to various factors.
Therefore, in order to prevent personal injury or fire arising from failure, please take safety measures such as complying with the derating characteristics, implementing redundant and fire prevention designs, and utilizing backups and fail-safe procedures. ROHM shall have no responsibility for any damages arising out of the use of our Products beyond the rating specified by ROHM.
- 4) Examples of application circuits, circuit constants and any other information contained herein are provided only to illustrate the standard usage and operations of the Products. The peripheral conditions must be taken into account when designing circuits for mass production.
- 5) The technical information specified herein is intended only to show the typical functions of and examples of application circuits for the Products. ROHM does not grant you, explicitly or implicitly, any license to use or exercise intellectual property or other rights held by ROHM or any other parties. ROHM shall have no responsibility whatsoever for any dispute arising out of the use of such technical information.
- 6) The Products specified in this document are not designed to be radiation tolerant.
- 7) For use of our Products in applications requiring a high degree of reliability (as exemplified below), please contact and consult with a ROHM representative : transportation equipment (i.e. cars, ships, trains), primary communication equipment, traffic lights, fire/crime prevention, safety equipment, medical systems, servers, solar cells, and power transmission systems.
- 8) Do not use our Products in applications requiring extremely high reliability, such as aerospace equipment, nuclear power control systems, and submarine repeaters.
- 9) ROHM shall have no responsibility for any damages or injury arising from non-compliance with the recommended usage conditions and specifications contained herein.
- 10) ROHM has used reasonable care to ensure the accuracy of the information contained in this document. However, ROHM does not warrants that such information is error-free, and ROHM shall have no responsibility for any damages arising from any inaccuracy or misprint of such information.
- 11) Please use the Products in accordance with any applicable environmental laws and regulations, such as the RoHS Directive. For more details, including RoHS compatibility, please contact a ROHM sales office. ROHM shall have no responsibility for any damages or losses resulting non-compliance with any applicable laws or regulations.
- 12) When providing our Products and technologies contained in this document to other countries, you must abide by the procedures and provisions stipulated in all applicable export laws and regulations, including without limitation the US Export Administration Regulations and the Foreign Exchange and Foreign Trade Act.
- 13) This document, in part or in whole, may not be reprinted or reproduced without prior consent of ROHM.



Thank you for your accessing to ROHM product informations.
More detail product informations and catalogs are available, please contact us.

ROHM Customer Support System

<http://www.rohm.com/contact/>