

Linear Regulator Series

Thermal Resistance Data: TO263-5

BD4xxM5WFP2-C Series

This application note provides the thermal resistance data of the TO263-5 package used for the thermal design of the BD4xxM5WFP2-C series linear regulator IC.

IC summary

The BD4xxM5WFP2-C series includes low quiescent current regulators with a breakdown voltage of 45 V, output current of 500 mA, and current consumption of 38 μ A. These regulators are ideal for reducing the current consumption of systems directly connected to batteries. They support AEC-Q100 and allow usage in every automotive application.

- Operating temperature range: T_J -40°C to +150°C
- Operating voltage range: 3.0 V to 42 V
- Low quiescent current: 38 μ A
- Output current: 500 mA
- Output voltage: 3.3 V, 5.0 V
- Output voltage precision: $\pm 2\%$

See Datasheet for more details.

Package

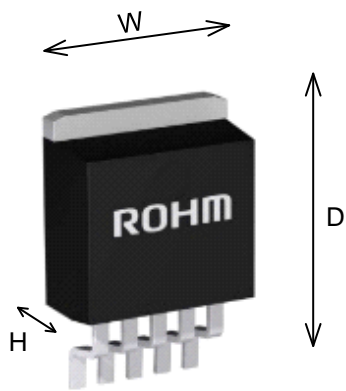

TO263-5

W (typ) D (typ) H (max)
10.16mm x 15.10mm x 4.70mm

Measurement environment

Content	Standard
Measurement environment	JEDEC STANDARD JESD51-2A (Still Air)
Measurement board standard	JEDEC STANDARD JESD51-3 JESD51-5 JESD51-7

Thermal resistance

Configuration	θ_{JA} (°C/W)	Ψ_{JT} (°C/W)
1 layer	74.7	8
2 layers	27.2	2
4 layers	20.5	1

θ_{JA} : Thermal resistance between
junction T_J - ambient temperature T_A

Ψ_{JT} : Thermal characteristics parameter between
junction T_J - package surface center temperature T_T

Note: The thermal resistances and thermal characteristics parameters in this application note are based on measurement under a JEDEC environment and may not always be consistent with the values for actual equipment. It is necessary to consider variations in the values due to the PCB characteristics, PCB layout, parts layout, chassis shape, surrounding environment, and so on.

PCB specifications, 1 layer (1s)

Conforms to JEDEC standard JESD51-3

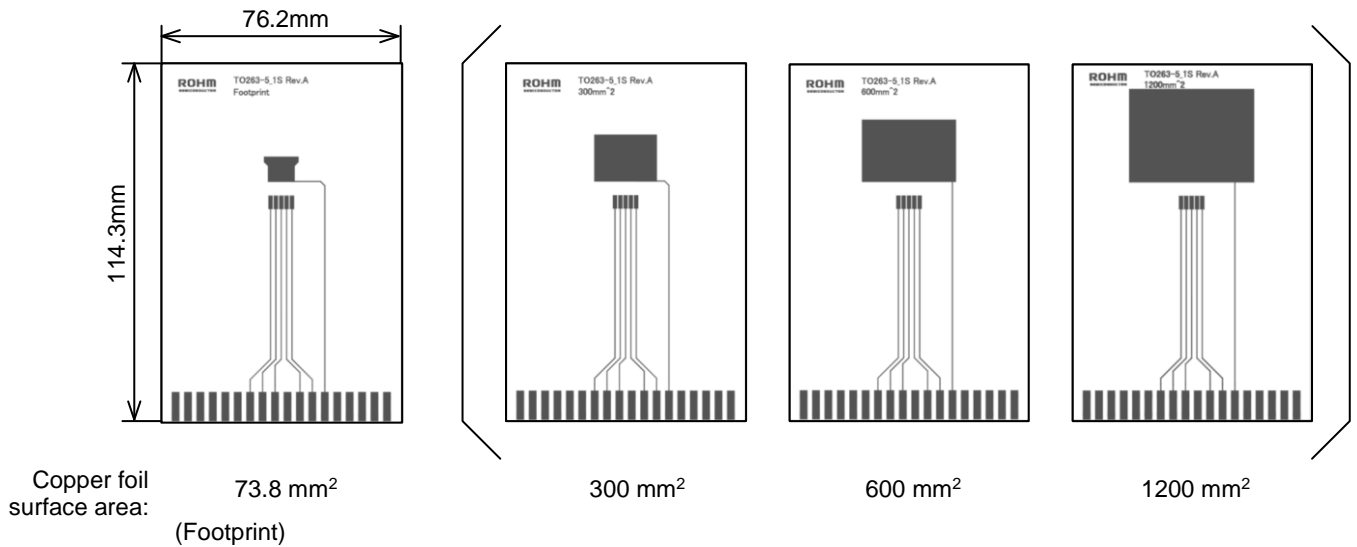

Figure 1. Top Layer Trace

Item	Value
Board thickness	1.57 mm
Board outline dimensions	76.2 mm × 114.3 mm
Board material	FR-4
Copper foil thickness	70 μm (2 oz copper foil)
Lead width	0.254 mm
Copper foil area	73.8 mm ² (Footprint), [300 mm ² , 600 mm ² , 1200 mm ²]

Table 1. 1 layer PCB specifications

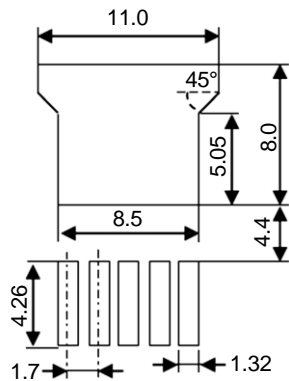

Figure 2. Footprint dimensions



Figure 3. 1 layer board sectional view

PCB specifications, 2 layers (2s)

Conforms to JEDEC standard JESD51-5, JESD51-7

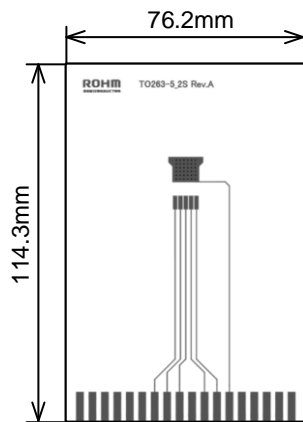

Figure 4. Top Layer Trace

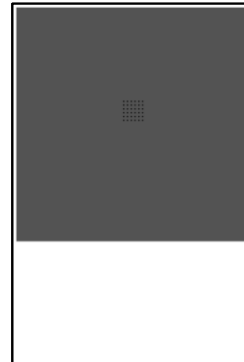

Figure 5. Bottom Layer Trace

Item	Value
Board thickness	1.60 mm
Board outline dimensions	76.2 mm × 114.3 mm
Board material	FR-4
Copper foil thickness	Top 70 μm (1 oz copper foil + plating) Bottom 70 μm (1 oz copper foil + plating)
Lead width	0.254 mm
Copper foil area	Top 73.8 mm ² (Footprint) Bottom 5,505 mm ² (74.2 mm × 74.2 mm)

Table 2. 2 layer PCB specifications

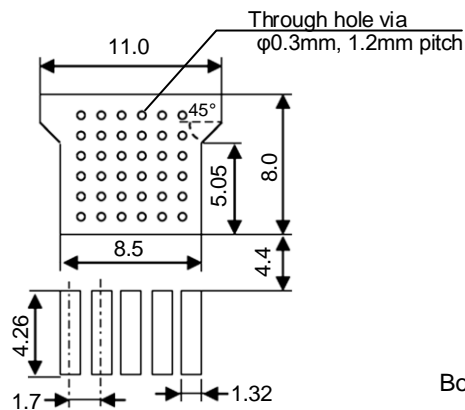

Figure 6. Footprint dimensions

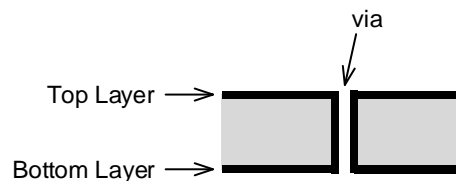

Figure 7. 2 layer board sectional view

PCB specifications, 4 layers (2s2p)

Conforms to JEDEC standard JESD51-5, JESD51-7

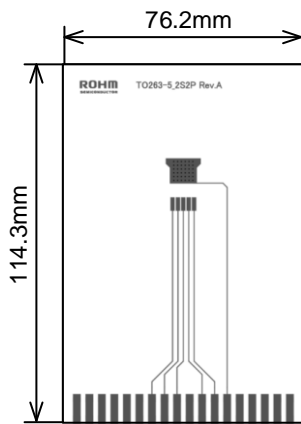

Figure 8.
Top Layer Trace

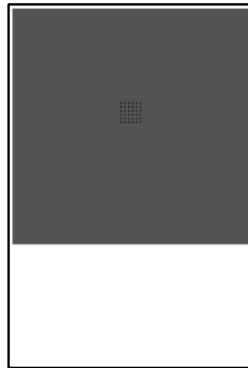

Figure 9.
Middle 1 Layer Trace

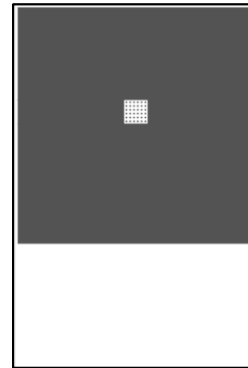

Figure 10.
Middle 2 Layer Trace

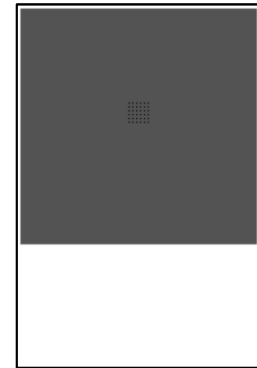

Figure 11.
Bottom Layer Trace

Item	Value
Board thickness	1.60 mm
Board outline dimensions	76.2 mm × 114.3 mm
Board material	FR-4
Copper foil thickness	Top 70 μm (1 oz copper foil + plating) Middle 1 35 μm (1 oz copper foil) Middle 2 35 μm (1 oz copper foil) Bottom 70 μm (1 oz copper foil + plating)
Lead width	0.254 mm
Copper foil area	Top 73.8 mm ² (Footprint) Middle 1 5505 mm ² (74.2 mm×74.2 mm) Middle 2 5505 mm ² (74.2 mm×74.2 mm) Bottom 5505 mm ² (74.2 mm×74.2 mm)

Table 3. 4 layer PCB specifications

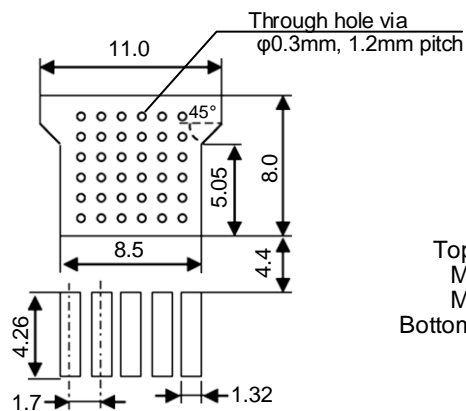

Figure 12. Footprint dimensions

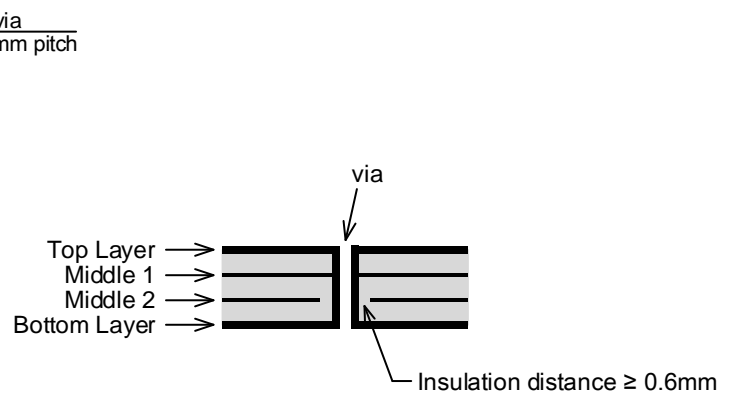

Figure 13. 4 layer board sectional view

Thermal resistance data, 1 layer (1s)

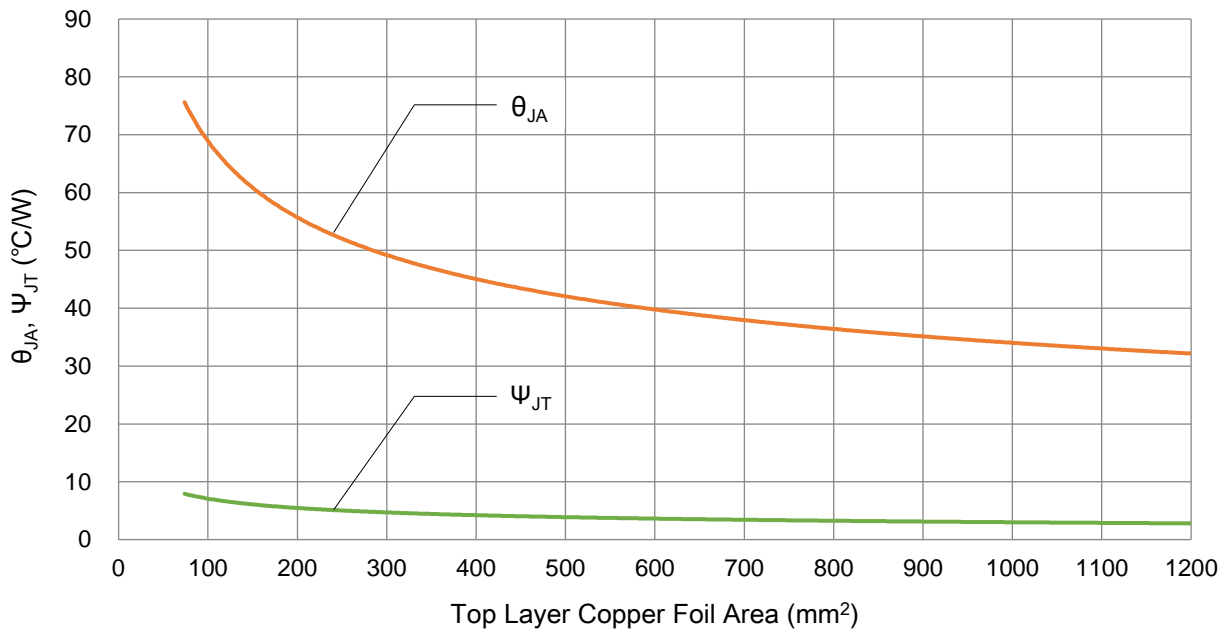

Figure 14. θ_{JA} , ψ_{JT} vs. copper foil surface area

Thermal resistance data, 2 layers (2s)

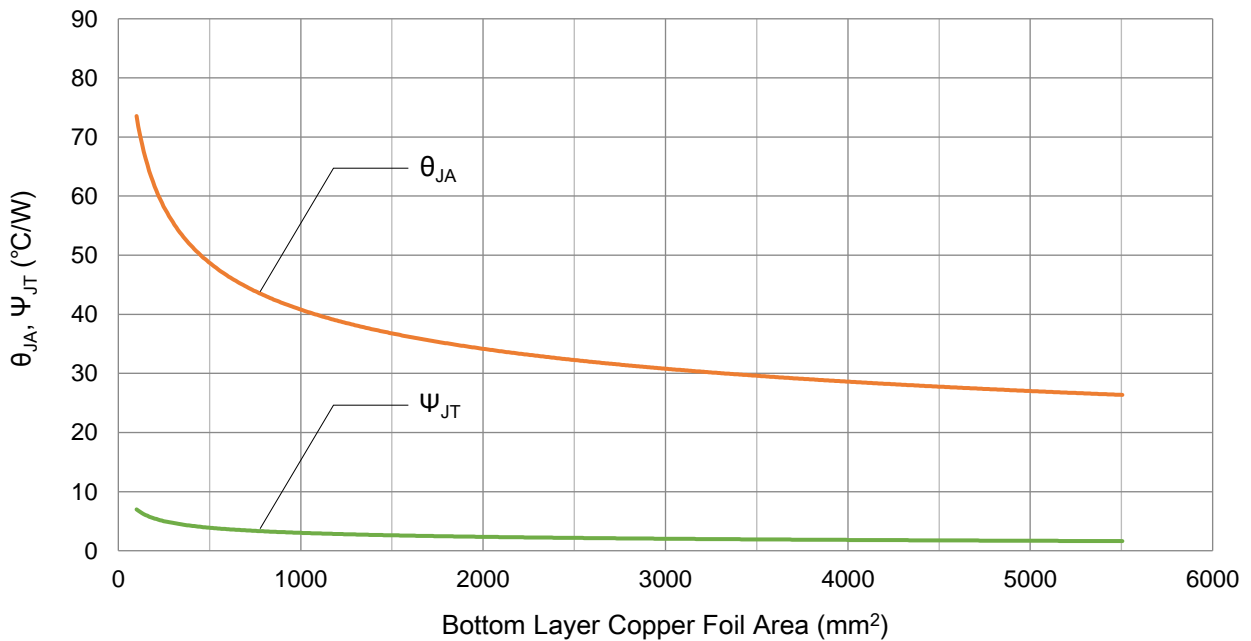

Figure 15. θ_{JA} , ψ_{JT} vs. copper foil back surface area

Transient thermal resistance data, 1 layer (1s)

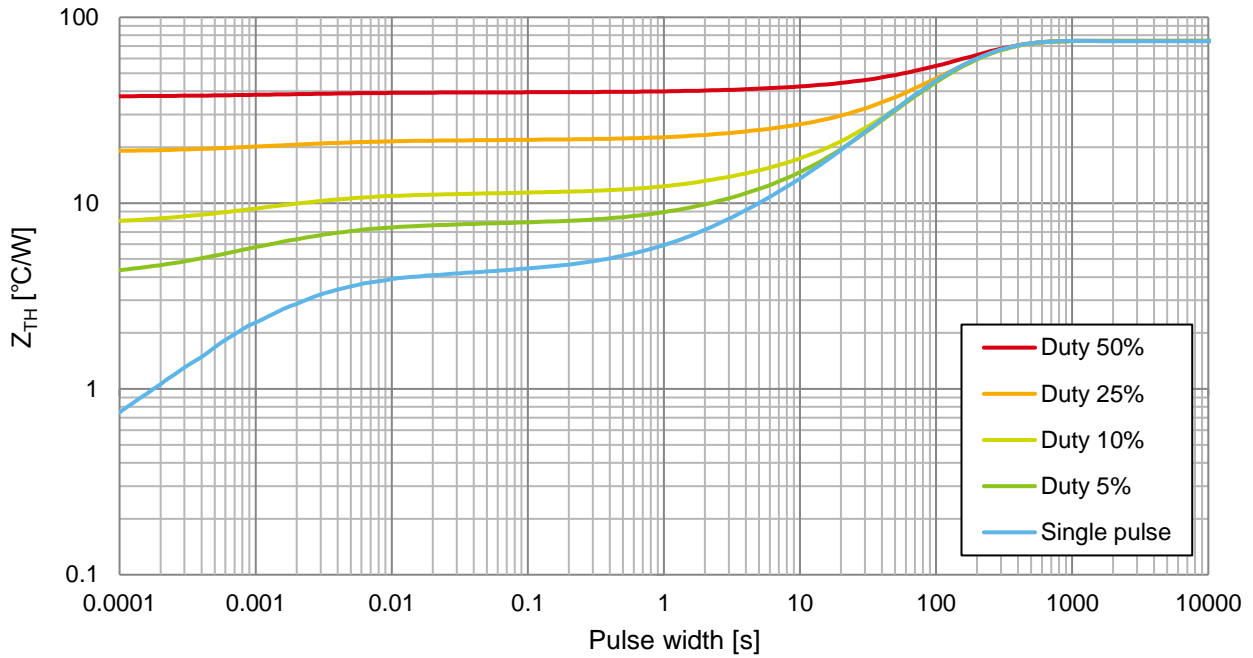

Figure 16. Transient thermal resistance, 1 layer
Copper foil surface area 73.8 mm² (Footprint)

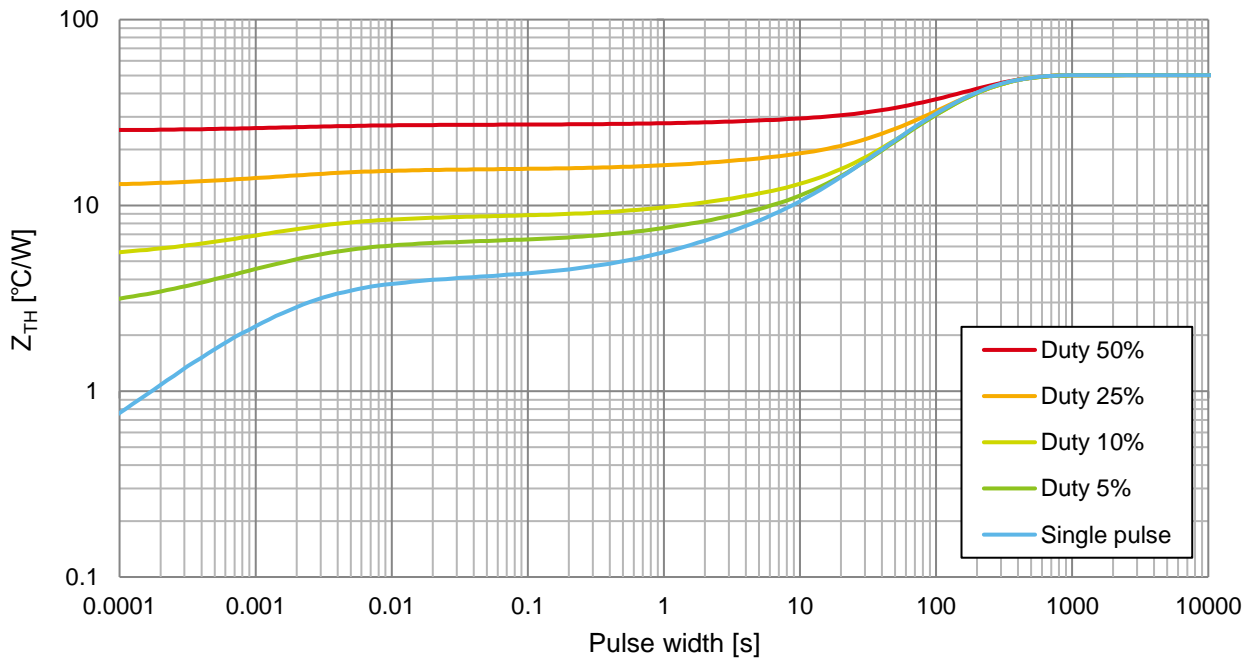

Figure 17. Transient thermal resistance, 1 layer
Copper foil surface area 300 mm²

Transient thermal resistance data, 1 layer (1s), continued

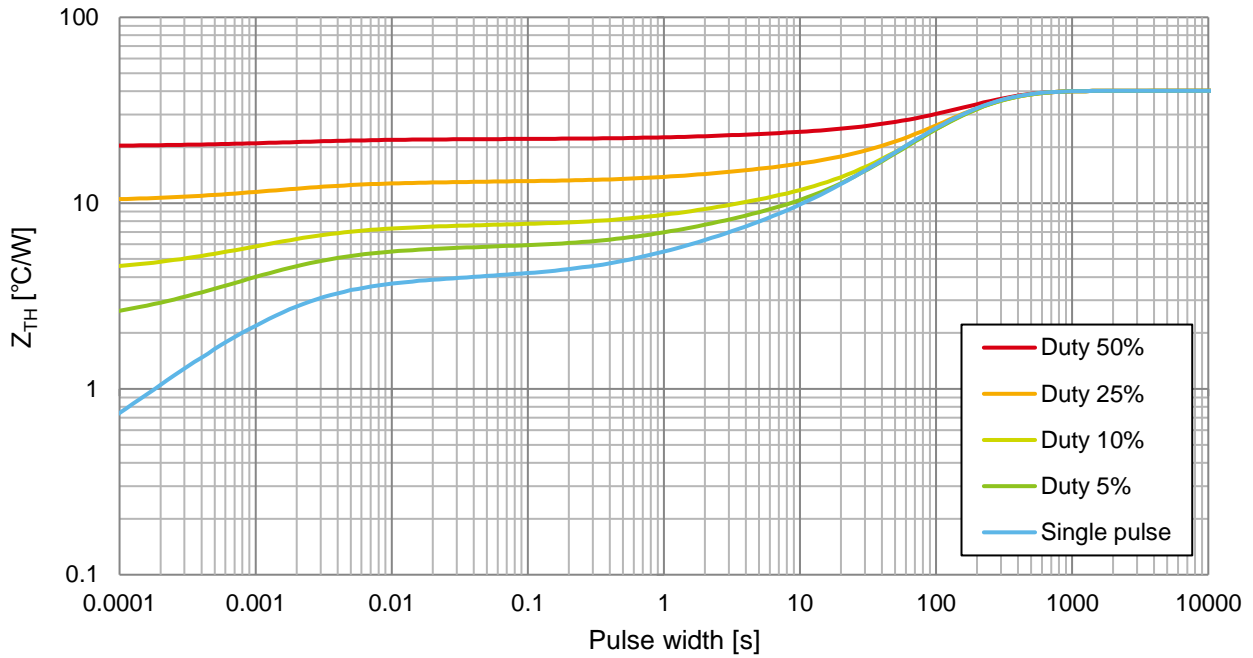

Figure 18. Transient thermal resistance, 1 layer
Copper foil surface area 600 mm²

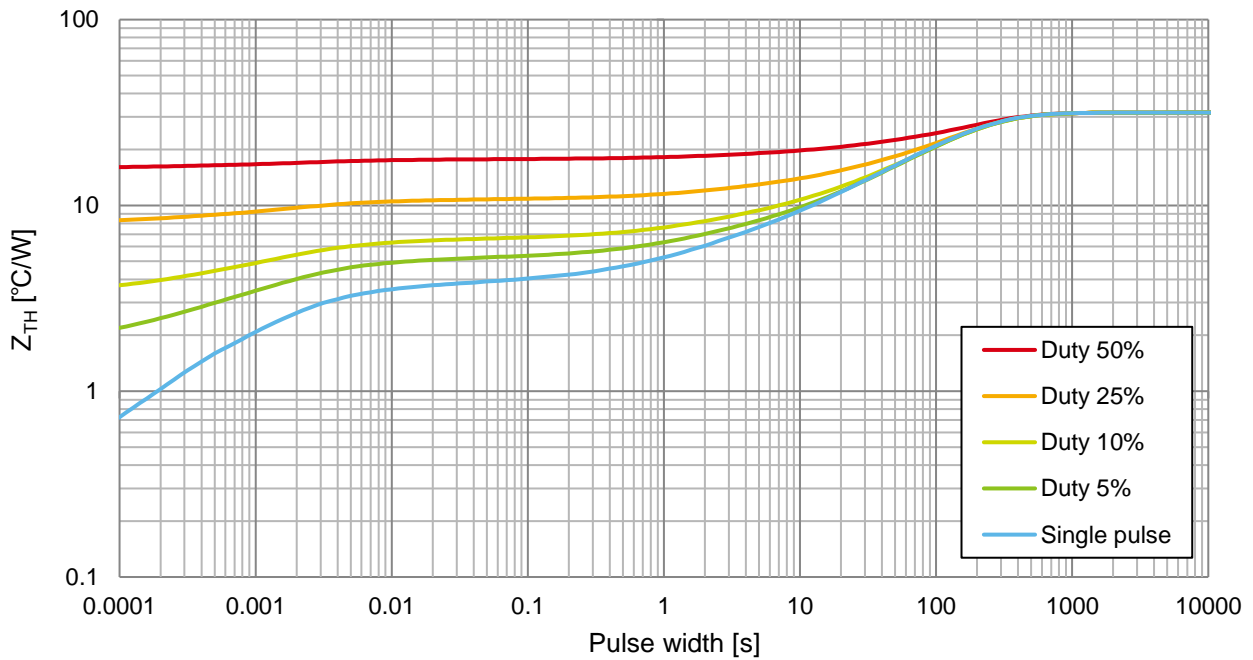

Figure 19. Transient thermal resistance, 1 layer
Copper foil surface area 1,200 mm²

Transient thermal resistance data, 2 layers (2s)

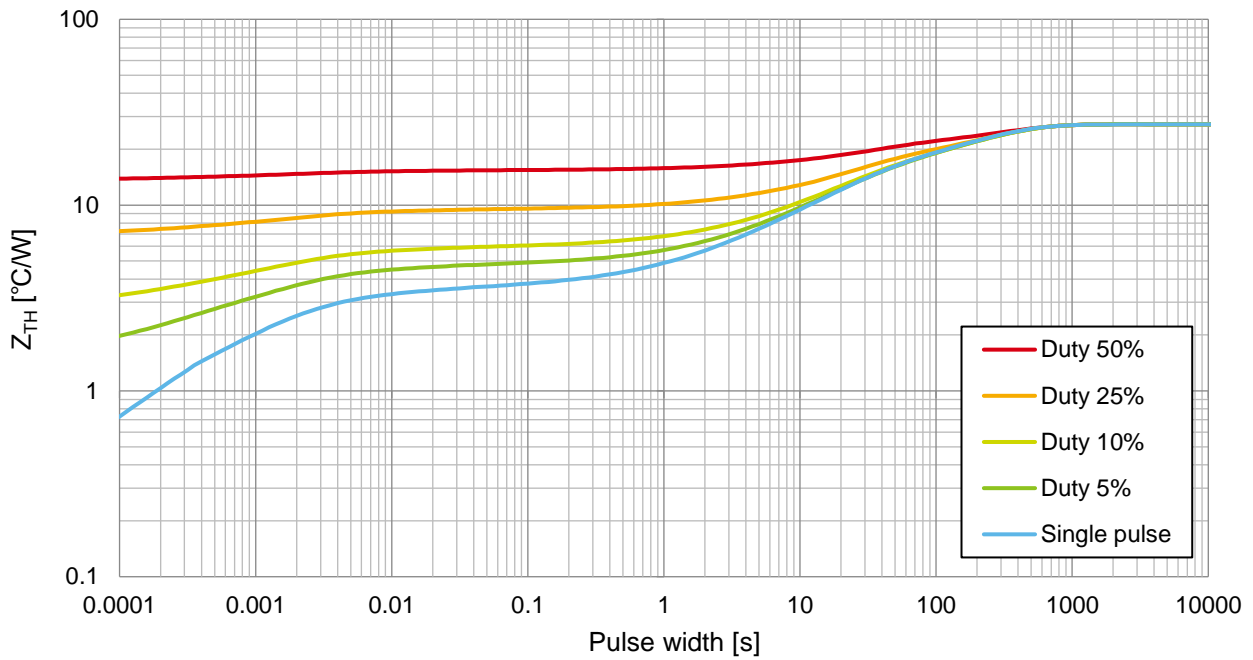

Figure 20. Transient thermal resistance, 2 layers

Transient thermal resistance data, 4 layers (2s2p)

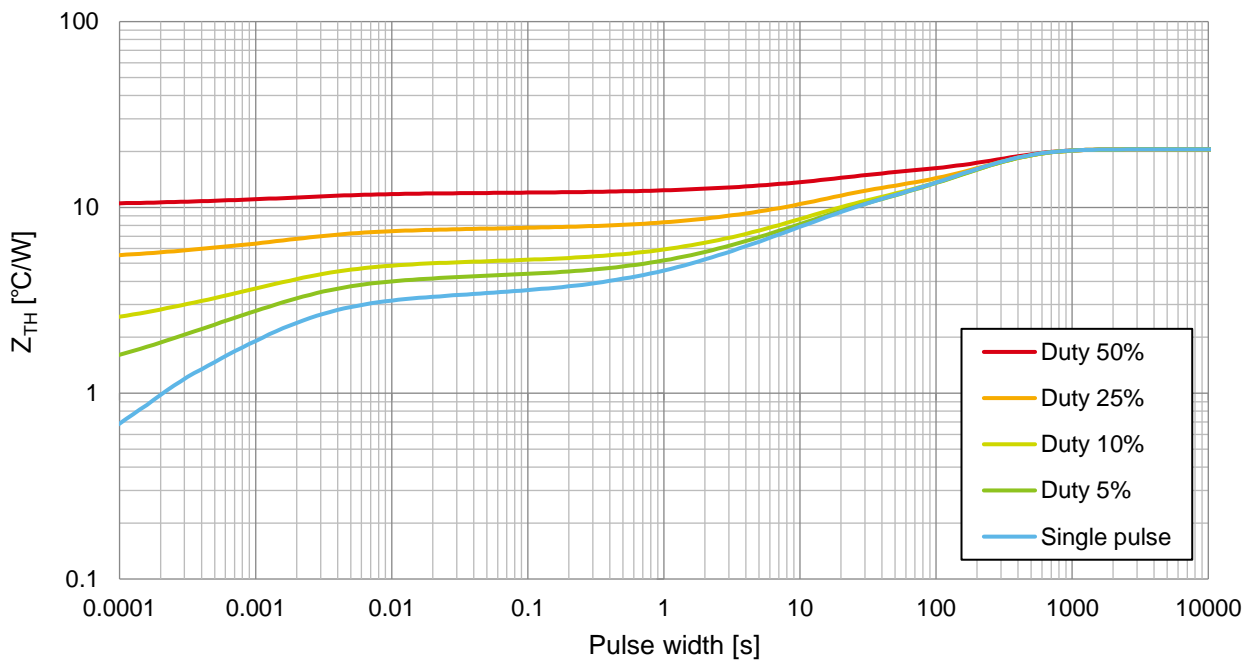

Figure 21. Transient thermal resistance, 4 layers

Notes

- 1) The information contained herein is subject to change without notice.
- 2) Before you use our Products, please contact our sales representative and verify the latest specifications :
- 3) Although ROHM is continuously working to improve product reliability and quality, semiconductors can break down and malfunction due to various factors.
Therefore, in order to prevent personal injury or fire arising from failure, please take safety measures such as complying with the derating characteristics, implementing redundant and fire prevention designs, and utilizing backups and fail-safe procedures. ROHM shall have no responsibility for any damages arising out of the use of our Products beyond the rating specified by ROHM.
- 4) Examples of application circuits, circuit constants and any other information contained herein are provided only to illustrate the standard usage and operations of the Products. The peripheral conditions must be taken into account when designing circuits for mass production.
- 5) The technical information specified herein is intended only to show the typical functions of and examples of application circuits for the Products. ROHM does not grant you, explicitly or implicitly, any license to use or exercise intellectual property or other rights held by ROHM or any other parties. ROHM shall have no responsibility whatsoever for any dispute arising out of the use of such technical information.
- 6) The Products specified in this document are not designed to be radiation tolerant.
- 7) For use of our Products in applications requiring a high degree of reliability (as exemplified below), please contact and consult with a ROHM representative : transportation equipment (i.e. cars, ships, trains), primary communication equipment, traffic lights, fire/crime prevention, safety equipment, medical systems, servers, solar cells, and power transmission systems.
- 8) Do not use our Products in applications requiring extremely high reliability, such as aerospace equipment, nuclear power control systems, and submarine repeaters.
- 9) ROHM shall have no responsibility for any damages or injury arising from non-compliance with the recommended usage conditions and specifications contained herein.
- 10) ROHM has used reasonable care to ensure the accuracy of the information contained in this document. However, ROHM does not warrants that such information is error-free, and ROHM shall have no responsibility for any damages arising from any inaccuracy or misprint of such information.
- 11) Please use the Products in accordance with any applicable environmental laws and regulations, such as the RoHS Directive. For more details, including RoHS compatibility, please contact a ROHM sales office. ROHM shall have no responsibility for any damages or losses resulting non-compliance with any applicable laws or regulations.
- 12) When providing our Products and technologies contained in this document to other countries, you must abide by the procedures and provisions stipulated in all applicable export laws and regulations, including without limitation the US Export Administration Regulations and the Foreign Exchange and Foreign Trade Act.
- 13) This document, in part or in whole, may not be reprinted or reproduced without prior consent of ROHM.



Thank you for your accessing to ROHM product informations.
More detail product informations and catalogs are available, please contact us.

ROHM Customer Support System

<http://www.rohm.com/contact/>