

Switching regulator series

Single Synchronous Buck DC/DC Converter BD9B406NF-Z Evaluation Board

BD9B406NF-EVK-001 (2.7V to 5.5V Input, 4A)

Introduction

This user's guide will provide the necessary steps to operate the Evaluation Board of ROHM's BD9B406NF-Z Buck DC/DC converters. This includes the external parts, operating procedures and application data.

Description

This Evaluation Board was developed for ROHM's Single Synchronous Buck DC/DC Converter BD9B406NF-Z. BD9B406NF-Z is a synchronous buck DC/DC converter with built-in low on-resistance power MOSFETs. The output voltage can achieve a high accuracy due to $\pm 1\%$ reference voltage. It features fast transient response due to constant on-time control system. The Light Load Mode control improves efficiency in light-load conditions. It is ideal for reducing standby power consumption of equipment. Power Good function makes it possible for system to control sequence. It achieves high power density and offers a small footprint on the PCB by employing 6 pins in a 1.5 mm x 1.5 mm small package.

Application

Printer, OA Equipment / Laptop PC / Tablet PC / Server / Storage Device (HDD / SSD)

Step-down Power Supply for SoC, FPGA, Microprocessor

Video Surveillance, LCD TV

Distributed Power Supply, Secondary Power Supply

Recommended Operating Conditions

Table 1. Recommended Operating Conditions

Parameter	Min	Typ	Max	Units	Conditions
Input Voltage	2.7	-	5.5	V	
Output Voltage	0.6	-	4.0	V	
Output Current (Note1)	-	-	4	A	
Switching Frequency	-	2.2	-	MHz	
On Time	-	248	-	ns	VIN = 3.3 V, VOUT = 1.8 V, PWM mode, Tj = 25 °C
Maximum Efficiency	-	93.6	-	%	VIN = 3.3 V, VOUT = 1.8 V, Tj = 25 °C
Maximum Efficiency	-	91.8	-	%	VIN = 5.0 V, VOUT = 1.8 V, Tj = 25 °C

(Note1) Tj must be lower than 125 °C under the actual operating environment.

Evaluation Board

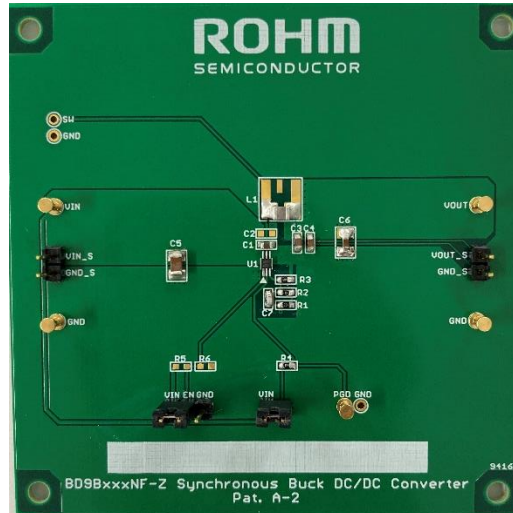

Figure 1. Evaluation Board Top View

Evaluation Board Schematic

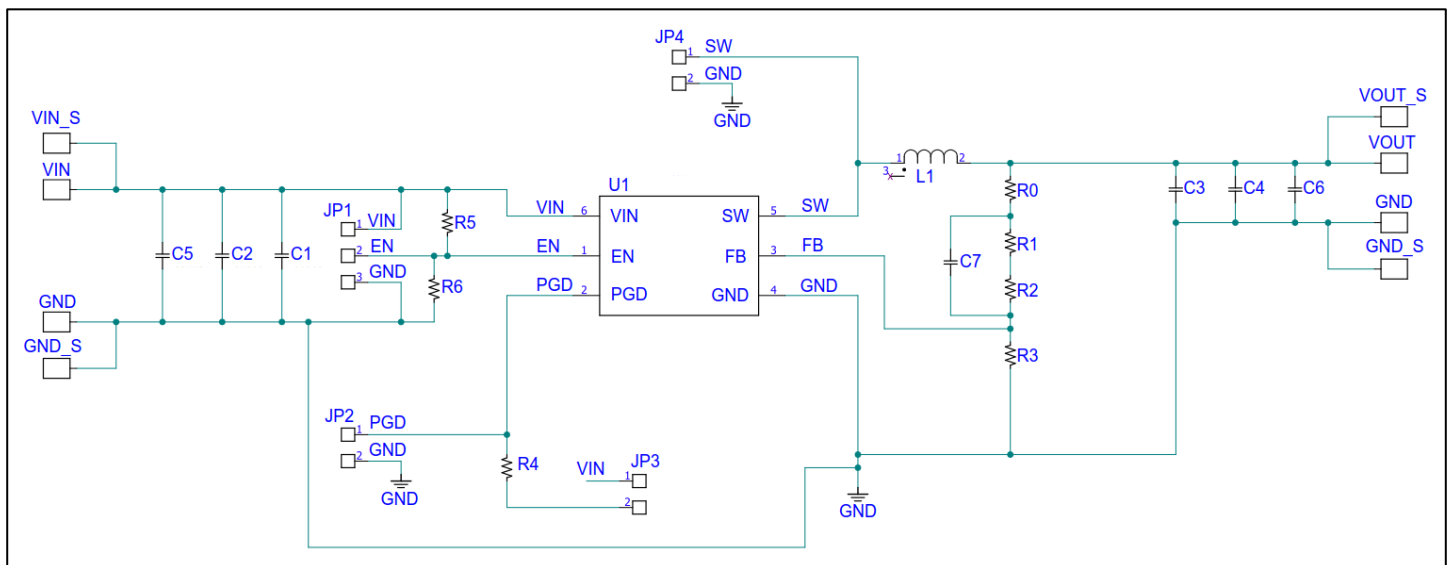

Figure 2. Circuit Diagram

Operating Procedure

1. Turn off EN and connect the GND terminal of the power supply to the GND terminal of Evaluation Board.
2. Connect power supply to the VIN terminal of the Evaluation Board.
3. Connect the load to the Evaluation Board's VOUT and GND terminals. When using an electronic load, connect with the load turned off.
4. Connect a voltmeter to the Evaluation Board's VOUT and GND terminals.
5. Turn on the Power supply of VIN. Turn on the switch of EN terminal.
6. Make sure that the voltmeter is set to measure voltage.
7. Turn on the electronic load.

(Caution) This Evaluation Board does not support hot plug. Do not perform hot plug test.

(Note) If EN = High (EN short to VIN) before power on, the turn on and turn off is controlled by VIN only.

Pin Configuration

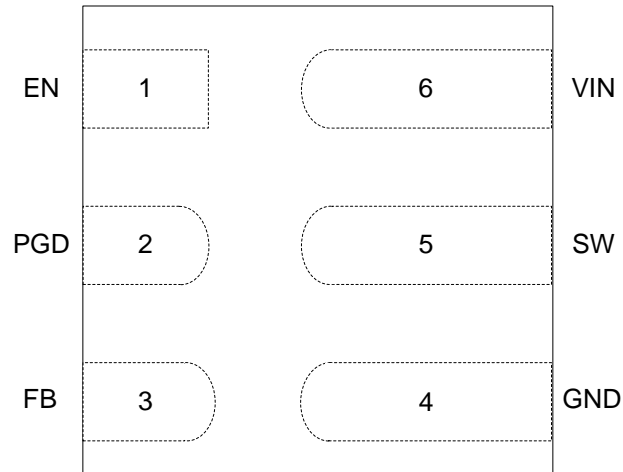

Figure 3. Pin Configuration

Parts list

Table 2. Parts list

No	Package	Parameters	Part Name (Series)	Type	Manufacturer
L1	2520	0.47 μ H	DFE252012F-R47M	Inductor	Murata
C1	1608	4.7 μ F (6.3 V)	JMK107BB7475MA	Ceramic Capacitor	Taiyo Yuden
C2	-	-	-	-	-
C3	1608	10 μ F (10 V)	GRM188Z71A106MA73	Ceramic Capacitor	Murata
C4	1608	10 μ F (10 V)	GRM188Z71A106MA73	Ceramic Capacitor	Murata
C5 (Note 1)	3225	47 μ F (10 V)	GRM32ER71A476ME15L	Ceramic Capacitor	Murata
C6	1608	10 μ F (10 V)	GRM188Z71A106MA73	Ceramic Capacitor	Murata
C7	1005	Depending on Table.3	GRM1555C2A Series	Ceramic Capacitor	Murata
R1	1005	Depending on Table.3	MCR01MZPF Series	Chip Resistor	ROHM
R2	1005	Depending on Table.3	MCR01MZPF Series	Chip Resistor	ROHM
R3	1005	Depending on Table.3	MCR01MZPF Series	Chip Resistor	ROHM
R4	1005	100 k Ω (1 %, 1/16 W)	MCR01MZPF1003	Chip Resistor	ROHM
R5	-	-	-	-	-
R6	-	-	-	-	-
R0 (Note 2)	-	Short	-	-	-
JP1	-	Short to VIN	EN switch	-	-
JP2	-	Open	PGOOD monitor pin	-	-
JP3	-	Short	PGOOD pull up pin	-	-
JP4	-	Open	SW monitor pin	-	-
VIN	-	-	Power of VIN supply	-	-
VIN_S	-	-	Sense of VIN	-	-
GND	-	-	Power of GND supply	-	-
GND_S	-	-	Sense of GND	-	-
VOUT	-	-	Power of VOUT supply	-	-
VOUT_S	-	-	Sense of VOUT	-	-

(Note 1) C5 is mounted to stabilize the power supply voltage and reduce input voltage ripple. Even if C5 is not used, the IC will operate normally.

(Note 2) R0 is an option, used for feedback's frequency characteristics measurement. By inserting a resistor at R0, it is possible to measure the frequency characteristics (phase margin) using an FRA. However, the resistor will not be used in actual application, use this resistor pattern in short-circuit mode.

Table 3. Recommended Feedback Resistances and CFB Capacitance

VIN	VOUT	RUP (Note 1)		RDW (Note 1)	CFB (Note 1)
		R1	R2	R3	C7
5.0 V	0.6 V	100 kΩ	0 Ω	Open	120 pF
5.0 V	0.9 V	100 kΩ	0 Ω	200 kΩ	120 pF
5.0 V	1.0 V	100 kΩ	0 Ω	150 kΩ	120 pF
5.0 V	1.2 V	150 kΩ	0 Ω	150 kΩ	120 pF
5.0 V	1.5 V	150 kΩ	0 Ω	100 kΩ	120 pF
5.0 V	1.8 V	200 kΩ	0 Ω	100 kΩ	120 pF
5.0 V	2.5 V	270 kΩ	47 kΩ	100 kΩ	47 pF
5.0 V	3.3 V	200 kΩ	12 kΩ	47 kΩ	33 pF
3.3 V	0.6 V	100 kΩ	0 Ω	Open	120 pF
3.3 V	0.9 V	100 kΩ	0 Ω	200 kΩ	120 pF
3.3 V	1.0 V	100 kΩ	0 Ω	150 kΩ	120 pF
3.3 V	1.2 V	150 kΩ	0 Ω	150 kΩ	120 pF
3.3 V	1.5 V	150 kΩ	0 Ω	100 kΩ	120 pF
3.3 V	1.8 V	200 kΩ	0 Ω	100 kΩ	68 pF

(Note 1) Please refer to P.19 of the datasheet for the details about setting RUP, RDW and CFB values.

(Note 2) The standard tolerance and wattage of R1, R2 and R3 is 1 %, 1/16 W.

Table 4. Recommended Inductors

Inductance [μH]	Part Name	Manufacturer	DCR [mΩ]	Current Rating [A]	L x W x H [mm]
0.47	DFE252012F-R47M	Murata	23	6.7	2.5 x 2.0 x 1.2
	DFE201610E-R47M	Murata	32	4.8	2.0 x 1.6 x 1.0
	LBENA2520MKTR47M0NK	TAIYO YUDEN	20	5.9	2.5 x 2.0 x 1.2
	LSEUC2016KKTR47M	TAIYO YUDEN	26	6.3	2.0 x 1.6 x 1.0
	TFM201610ALM-R47MTAA	TDK	34	5.1	2.0 x 1.6 x 1.0
	XGL4015-471ME	Coilcraft	7.5	10.5	4.0 x 4.0 x 1.5
	XFL4015-471ME	Coilcraft	8.36	6.6	4.0 x 4.0 x 1.6
	XEL3520-471ME	Coilcraft	10.85	8.0	3.5 x 3.2 x 2.0

(Note) If the recommended parts on tables 2, 3 and 4 are not available anymore due to end of production, different parts will be used on the test board because the end of production parts are deprecated.

Board Layout

Evaluation Board PCB information

Number of Layers	Material	Board Size	Copper Thickness
4	FR4	80mm x 80mm x 1.6mm	2oz (70μm) / 1oz (35μm) / 1oz (35μm) / 2oz(70μm)

The layout of BD9B406NF series is shown below:

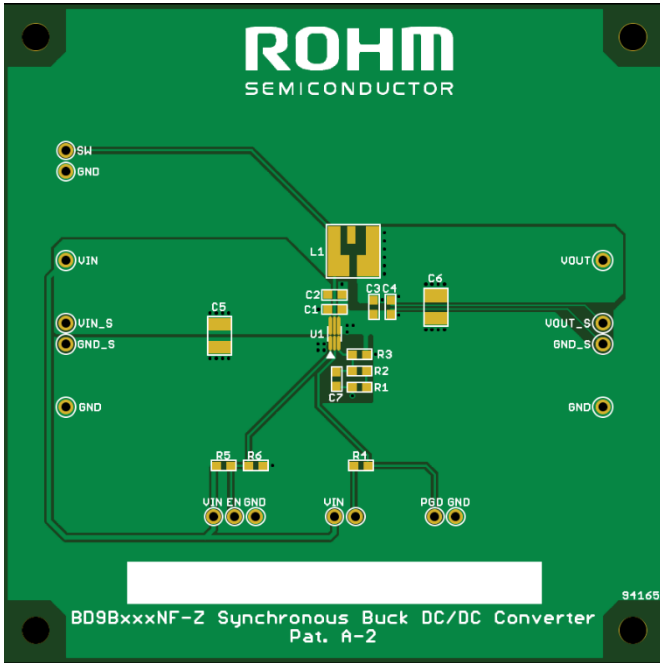

Figure 4. Top PCB Image

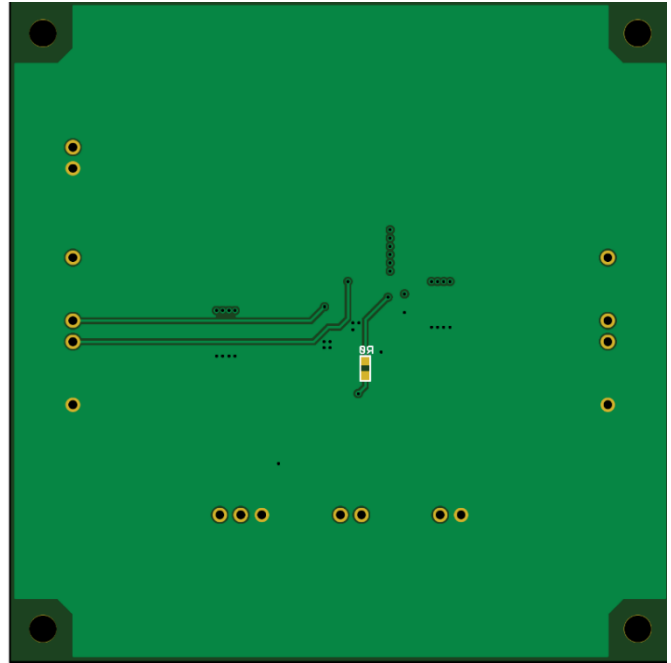

Figure 5. Bottom PCB Image

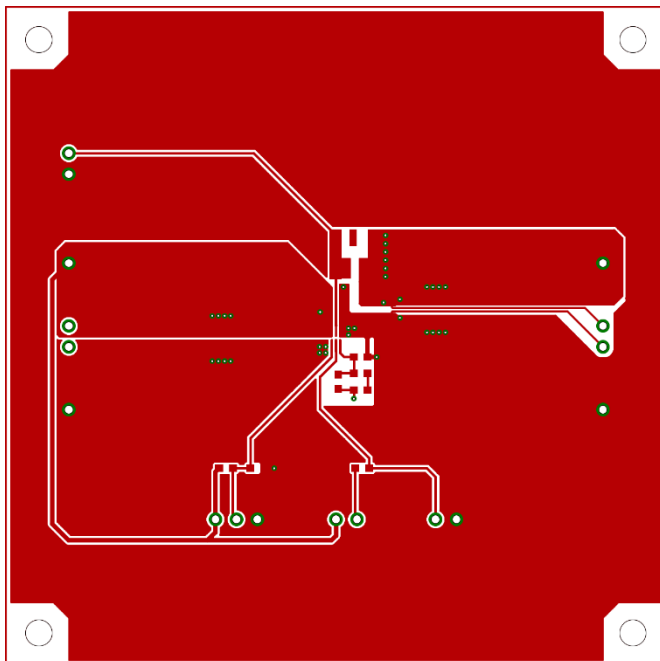

Figure 6. Top Layer Layout

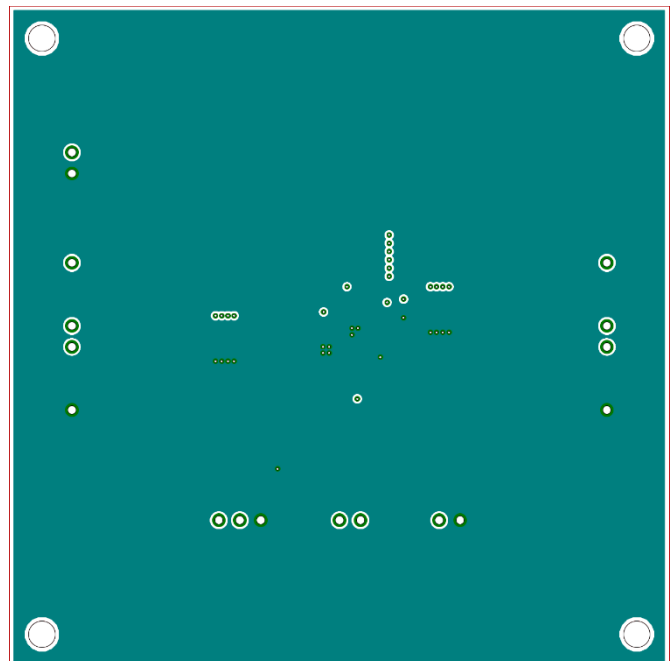

Figure 7. Middle1 Layer Layout

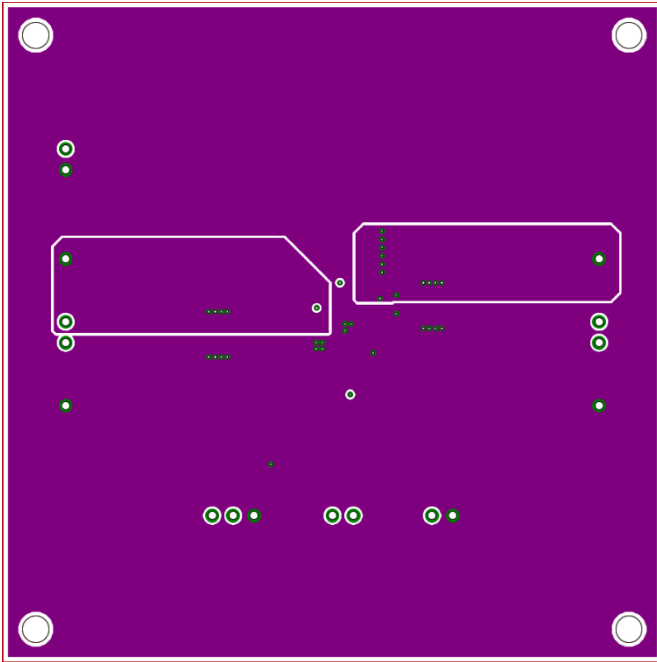

Figure 8. Middle2 Layer Layout

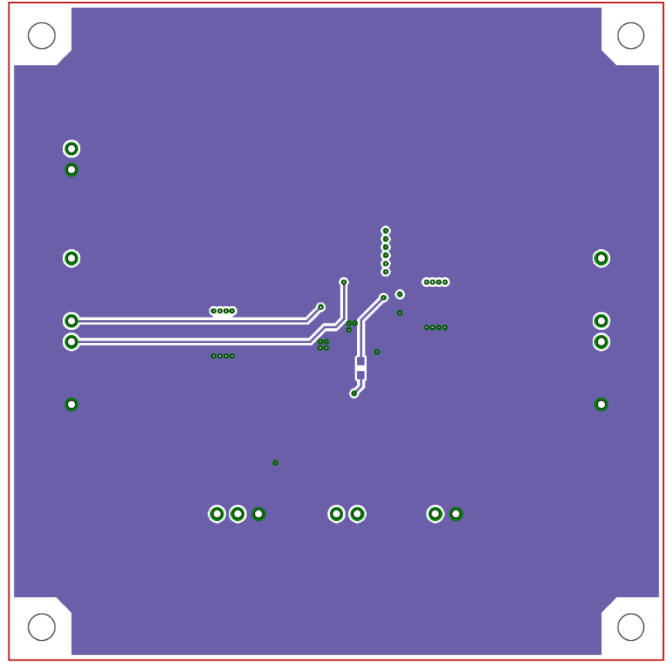

Figure 9. Bottom Layer Layout

Reference Application Data

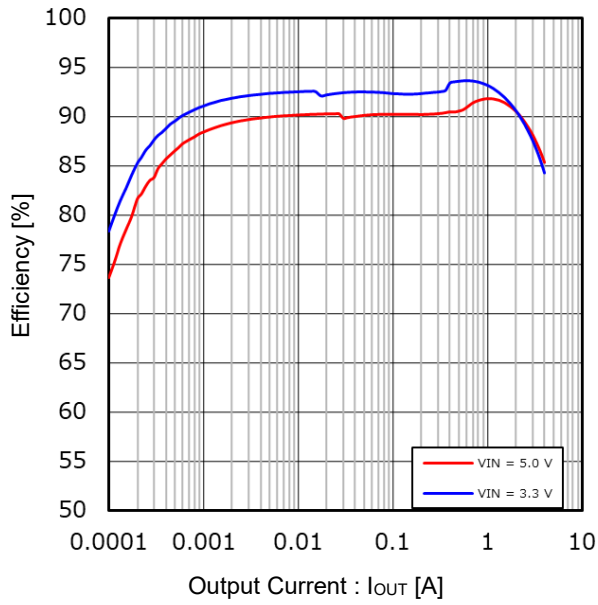

Figure 10. Efficiency vs Output Current
(VOUT = 1.8 V)

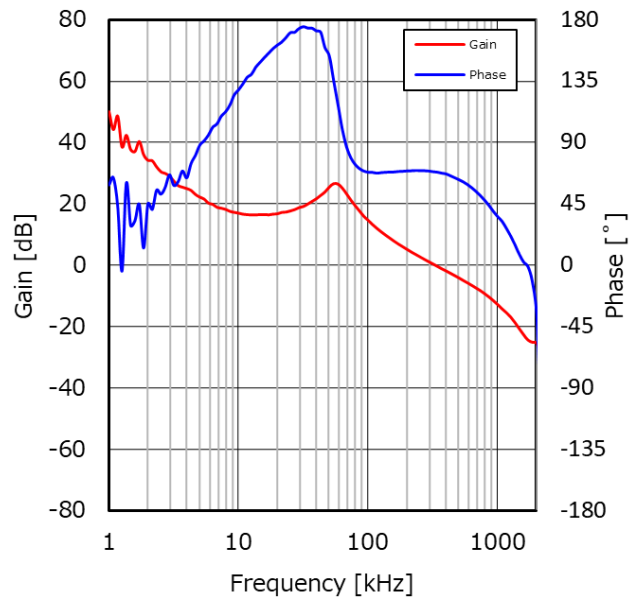

Figure 11. Frequency Characteristics
(VIN = 5 V, VOUT = 1.8 V, IOUT = 1 A)

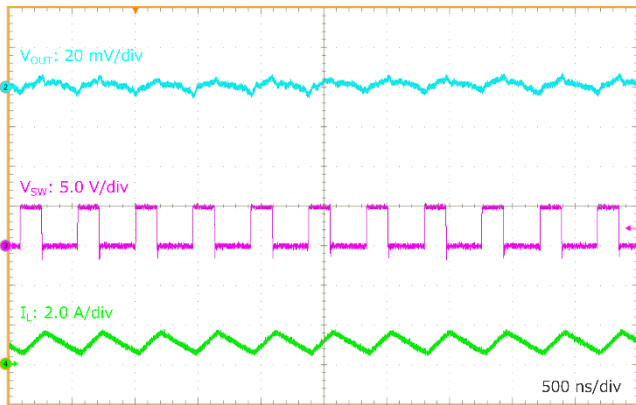

Figure 12. VOUT Ripple
(VIN = 5 V, VOUT = 1.8 V, IOUT = 1 A)

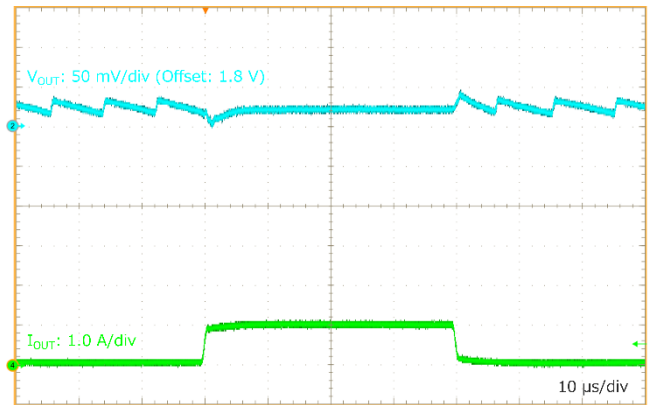

Figure 13. Load Transient Response
(VIN = 5 V, VOUT = 1.8 V, IOUT = 0.05 to 1 A)

Other series application data please refer to datasheet.

Revision History

Date	Revision	Changes
24.Aug.2023	Rev. 001	Initial release

Notice

- 1) The information contained in this document is intended to introduce ROHM Group (hereafter referred to as ROHM) products. When using ROHM products, please verify the latest specifications or datasheets before use.
- 2) ROHM products are designed and manufactured for use in general electronic equipment and applications (such as Audio Visual equipment, Office Automation equipment, telecommunication equipment, home appliances, amusement devices, etc.) or specified in the datasheets. Therefore, please contact the ROHM sales representative before using ROHM products in equipment or devices requiring extremely high reliability and whose failure or malfunction may cause danger or injury to human life or body or other serious damage (such as medical equipment, transportation, traffic, aircraft, spacecraft, nuclear power controllers, fuel control, automotive equipment including car accessories, etc. hereafter referred to as Specific Applications). Unless otherwise agreed in writing by ROHM in advance, ROHM shall not be in any way responsible or liable for any damages, expenses, or losses incurred by you or third parties arising from the use of ROHM Products for Specific Applications.
- 3) Electronic components, including semiconductors, can fail or malfunction at a certain rate. Please be sure to implement, at your own responsibilities, adequate safety measures including but not limited to fail-safe design against physical injury, and damage to any property, which a failure or malfunction of products may cause.
- 4) The information contained in this document, including application circuit examples and their constants, is intended to explain the standard operation and usage of ROHM products, and is not intended to guarantee, either explicitly or implicitly, the operation of the product in the actual equipment it will be used. As a result, you are solely responsible for it, and you must exercise your own independent verification and judgment in the use of such information contained in this document. ROHM shall not be in any way responsible or liable for any damages, expenses, or losses incurred by you or third parties arising from the use of such information.
- 5) When exporting ROHM products or technologies described in this document to other countries, you must abide by the procedures and provisions stipulated in all applicable export laws and regulations, such as the Foreign Exchange and Foreign Trade Act and the US Export Administration Regulations, and follow the necessary procedures in accordance with these provisions.
- 6) The technical information and data described in this document, including typical application circuits, are examples only and are not intended to guarantee to be free from infringement of third parties intellectual property or other rights. ROHM does not grant any license, express or implied, to implement, use, or exploit any intellectual property or other rights owned or controlled by ROHM or any third parties with respect to the information contained herein.
- 7) No part of this document may be reprinted or reproduced in any form by any means without the prior written consent of ROHM.
- 8) All information contained in this document is current as of the date of publication and subject to change without notice. Before purchasing or using ROHM products, please confirm the latest information with the ROHM sales representative.
- 9) ROHM does not warrant that the information contained herein is error-free. ROHM shall not be in any way responsible or liable for any damages, expenses, or losses incurred by you or third parties resulting from errors contained in this document.



Thank you for your accessing to ROHM product informations.
More detail product informations and catalogs are available, please contact us.

ROHM Customer Support System

<https://www.rohm.com/contactus>