

Switching Regulator Series

Buck Converter with Integrated FET BD9G102G-LB EVK

BD9G102G-EVK-001 (18V→ 5V, 0.5A)

Introduction

This user's guide will provide the steps necessary to operate the BD9G102G-EVK-001 and evaluate ROHM's BD9G102G-LB 1channel Buck DC/DC converter. Component selection, operating procedures, and application data are included.

Description

This EVK has been developed for ROHM's non-synchronous buck DC/DC converter customers evaluating BD9G102G-LB. While the BD9G102G-LB accepts a power supply input range of 6V to 42V, and generates output voltages from 0.75V ^(Note 1) to VCC×0.8, this EVK is setup for the input voltage range of 8V to 42V and a fixed output of 5V can be produced. The IC has internal 800mΩ N-channel MOSFET and the operating frequency is fixed 1.0MHz. A fixed Soft Start circuit prevents inrush current during startup along with UVLO (under voltage lock out), OVP (over voltage protection) and TSD (thermal shutdown detection), OCP (over current protection) protection circuits. The under voltage lock out and hysteresis can be set by external resistor using EN pin. EN pin allows for simple ON/OFF control of the IC to reduce standby current consumption.

^(Note 1) Restricted by Minimum duty cycle. (About the restriction of input/output voltage by minimum duty cycle, refer to p.5 of the datasheet)

Application

Industrial Equipment
Battery Powered Equipment
OA Instrument

Operating Limits

Parameter	Min	Typ	Max	Units	Conditions
Input Voltage	8	18	42	V	
Output Voltage		5.0		V	
Output Current Range			0.5	A	
Operating Frequency		1000		kHz	
Maximum Efficiency		86		%	IOUT = 0.5A
UVLO Detect Voltage		5.3		V	VCC sweep down
UVLO Release Voltage		5.5		V	VCC sweep up

EVK

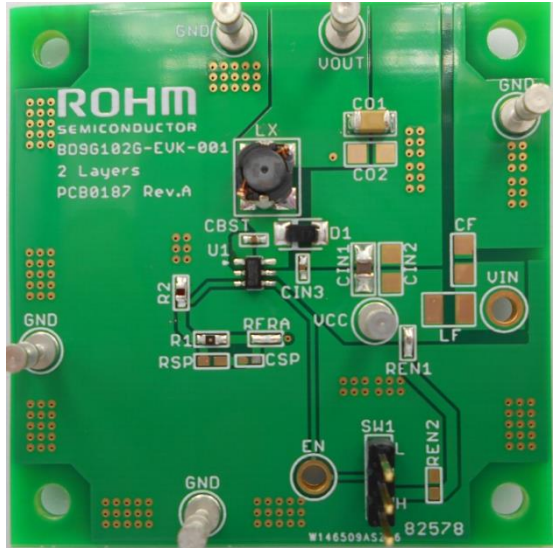

Figure 1. BD9G102G-EVK-001(Top View)

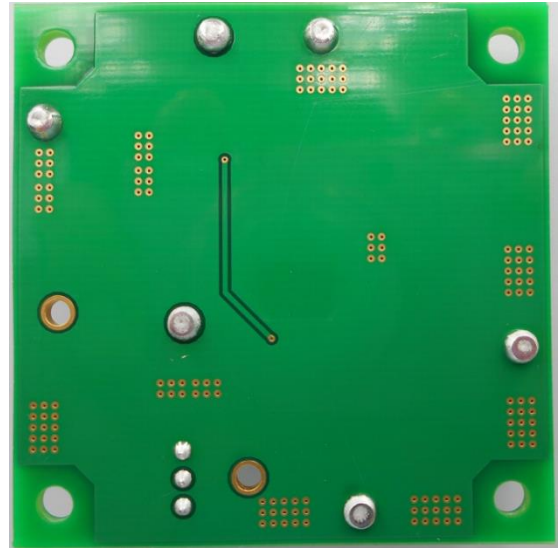

Figure 2. BD9G102G-EVK-001(Bottom View)

EVK Schematic

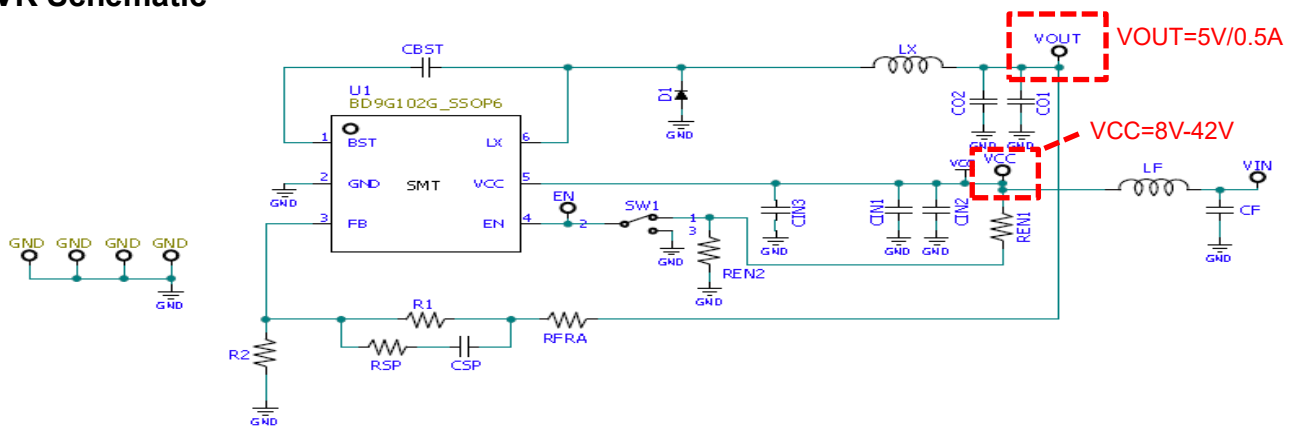

Figure 3. BD9G102G-EVK-001 Schematic

The input/output pins are in the broken line (VCC pin and VOUT pin) in Figure 3.

Operating Procedure

Below is the procedure to operate the EVK.

1. Turn off the power supply and connect power supply's GND pin to the GND pin of the EVK.
2. Connect the power supply's positive pin to the VCC pin of the EVK.
3. Connect the shunt jumper of SW1 is at position "H" (The EN pin of IC U1 is pulled high. In the default setting, EN is high that is connected by VCC and REN1.)
4. Check if the electronic load is turned off and connect the electronic load to the VOUT pin and the GND pin of the EVK.
5. Connect the voltmeter to the VOUT pin and the GND pin of the EVK.
6. Turn on the power supply and check if the measured value of the voltmeter is 5V.
7. Turn on the electronic load.

Notes:

The board does not support hot plugging protection. Do not perform hot plugging on this board.

Operation State Settings

Below is a table of BD9G102G-LB condition selectable using EN terminal

Table 1. . EN Pin Settings

EN terminal voltage	BD9G102G-LB condition
EN > 1.8 V	Enable
1.8 V ≥ EN > 0.5 V	Internal REG circuit turn on
EN ≤ 0.5 V	Shutdown

Please refer to item 9 of the data sheet page 3 and p20 (7) for how to set the voltage divider resistance of the external UVLO.

BOM

Below is a table with the bill of materials.

Table 2. Bill of Materials

Quantity	Reference Designator	Part Number	Manufacturer	Value	Description [Unit: inch (mm)]
IC					
1	U1	BD9G102G-LB	ROHM		Buck
Capacitor					
1	CIN1	GRM21BC71H475KE11L	Murata	4.7μF	Capacitor, 50V, ±10%, 0805 (2012)
1	CIN2	-	-	-	Open
1	CIN3	GRM155R71H104KE14D	Murata	0.1μF	Capacitor, 50V, ±10%, 0402 (1005)
1	CO1	GRM31CC81E226KE11L	Murata	22μF	Capacitor, 25V, ±20%, 1206 (3216)
1	CO2	-	-	-	Open
1	CBST	GRM155R61E104KA87D	Murata	0.1μF	Capacitor, 25V, ±10%, 0402 (1005)
1	CSP	-	-	-	Open
Resistor					
1	R1	MCR03EZPF6802	ROHM	68kΩ	Resistor, 50V, 0.1W, ±1%, 0603 (1608)
1	R2	MCR03EZPF1202	ROHM	12kΩ	Resistor, 50V, 0.1W, ±1%, 0603 (1608)
1	RFRA	-	-	-	Short
1	RSP	-	-	-	Open
1	REN1	-	-	-	Short
1	REN2	-	-	-	Open
Diode					
1	D1	RB060MM-60	ROHM		Diode, 60V, 2A, 1406 (3516)
Inductor					
1	LX	CLF5030NIT-220M-D	TDK	22μH	Inductor, 1.1A(max), ±20%, 2120 (5.3 x 5.0)
Common Mode Filter					
1	LF	-	-	-	Open
1	CF	-	-	-	Open

Recommended parts are selected from those products and information available at the time this user's guide (Rev.002) was released. If supply conditions change and parts are not available, use similar parts.

Board Layout

EVK PCB information

Number of Layers	Material	Board Size	Copper Thickness
2	FR-4	50mm x 50mm x 1.6mmt	1oz (35μm)

Followings are the layout of BD9G102G-EVK-001

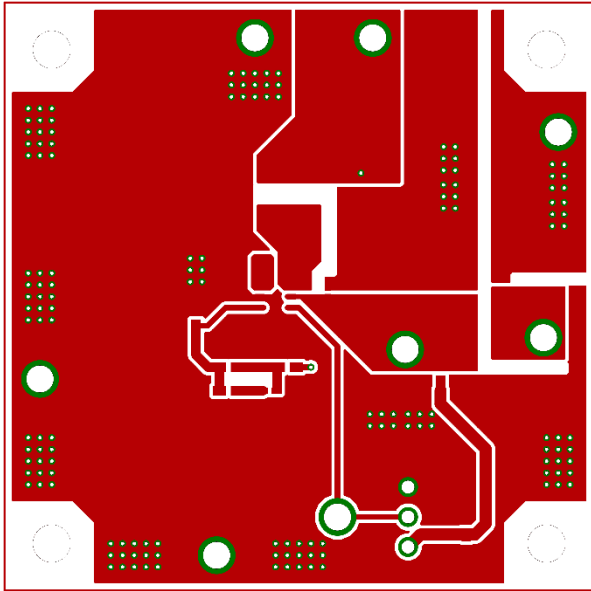

Figure 4. Top Layer Layout
(Top View)

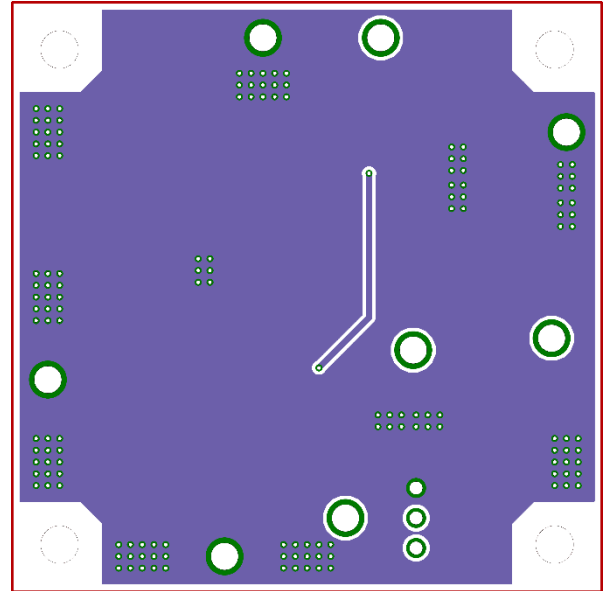

Figure 5. Bottom Layer Layout
(Top View)

Reference Application Data

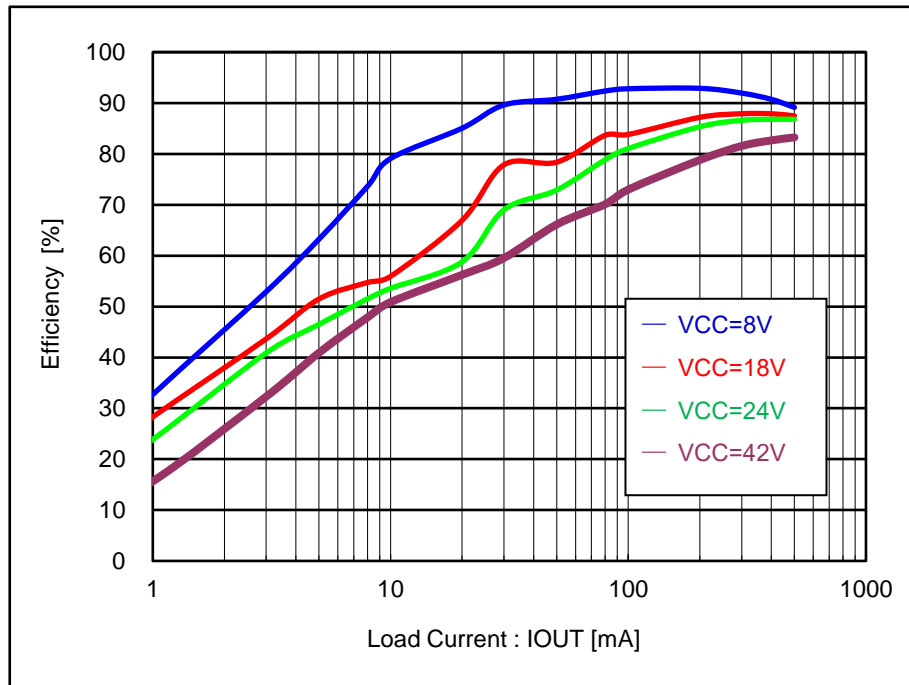

Figure 6. Efficiency vs Load Current (VCC=8V to 42V, VOUT=5V)

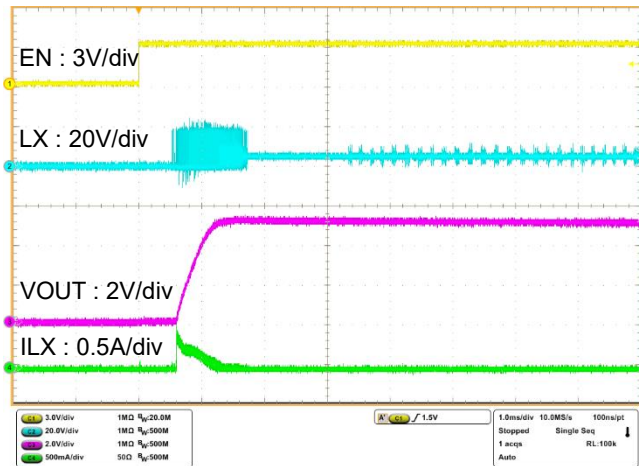

Figure 7. Start-up Characteristics (VCC=18V, VOUT=5V, IOU=0mA)

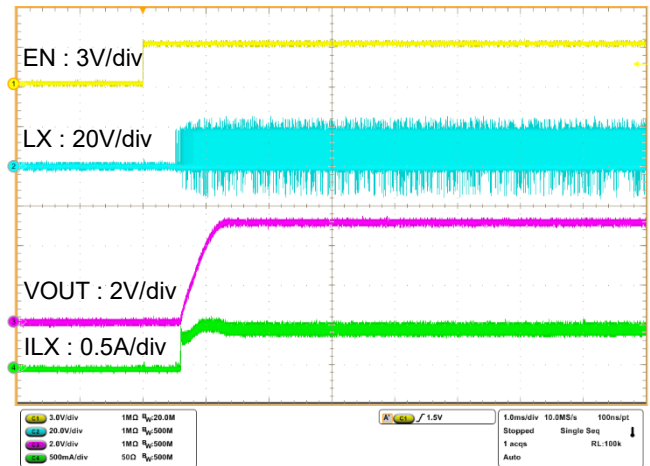

Figure 8 Start-up Characteristics (VCC=18V, VOUT=5V, IOU=500mA)

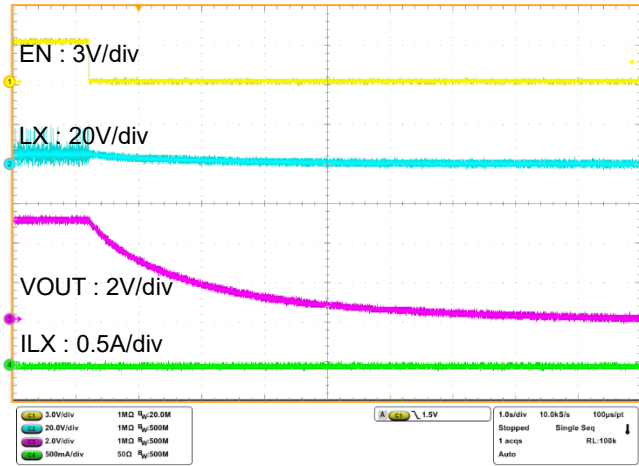

Figure 9 Shut-down Characteristics
(VCC=18V, VOUT=5V, IOUT=0mA)

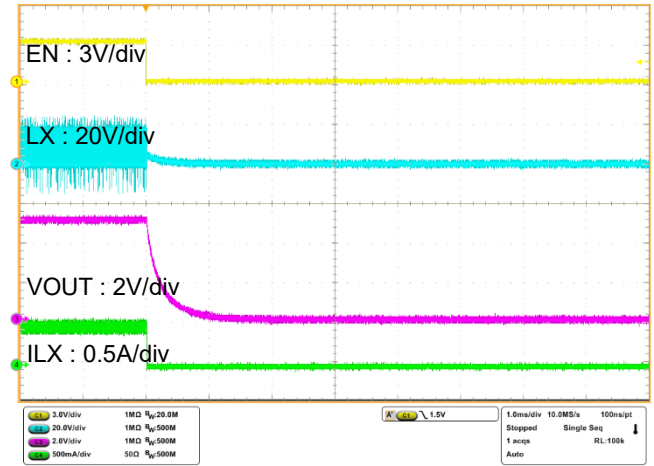

Figure 10 Shut-down Characteristics
(VCC=18V, VOUT=5V, IOUT=500mA)

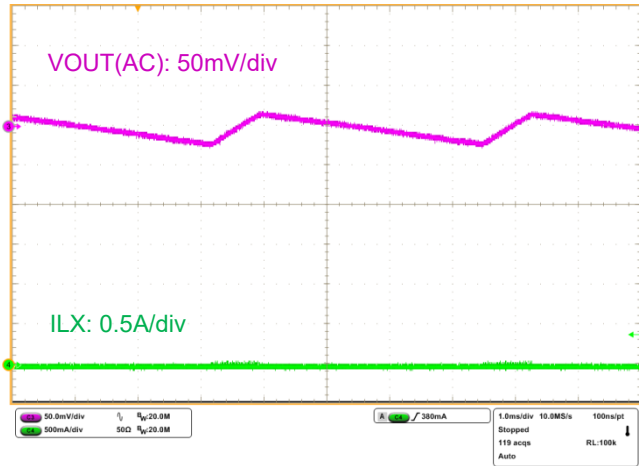

Figure 11. Output Ripple Voltage
(VCC=18V, VOUT=5V, IOUT=0A)

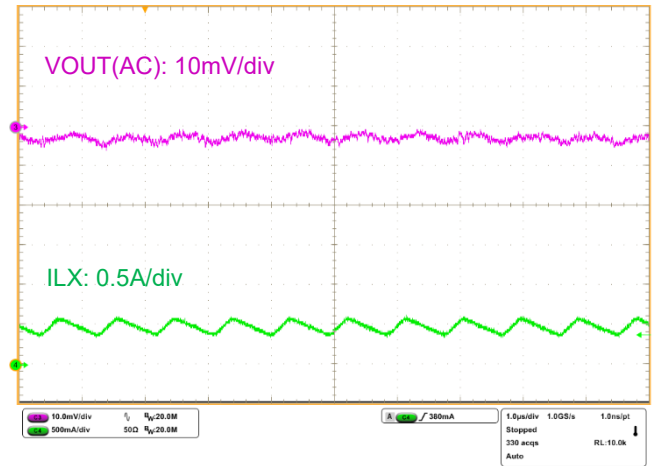

Figure 12. Output Ripple Voltage
(VCC=18V, VOUT=5V, IOUT=500mA)

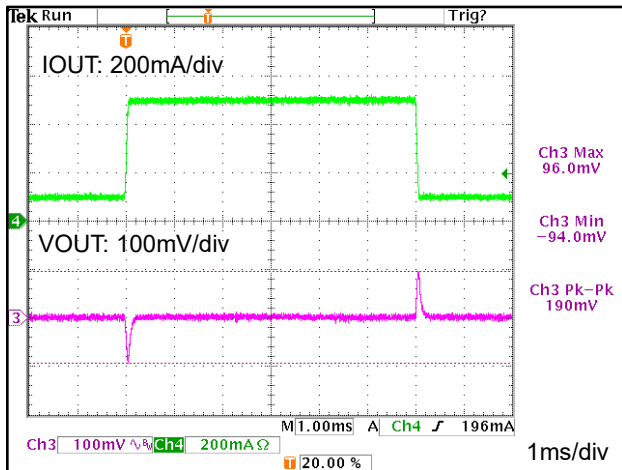

Figure 13. Load Response
(VCC=18V, VOUT=5V, IOUT=100mA↔500mA)

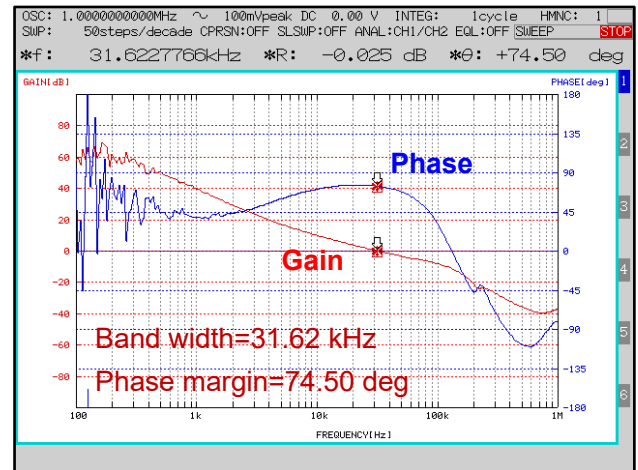

Figure 14. Frequency Response
(VCC=18V, VOUT=5V, IOUT=500mA)

Revision History

Date	Revision Number	Description
29. Jun. 2020	001	Initial release
10. Dec. 2023	002	<p>p.1 Changed Operating Limits condition from I_o to IOUT.</p> <p>p.3 U1 of Table.2 is changed from BD9G102G to BD9G102G-LB.</p> <p>p.3 CBST of Table.2 is changed from GRM266R71H104ME14D to RM155R61E104KA87D. Changed from "Capacitor, 50V, ±10%" to "Capacitor, 25V, ±10%".</p> <p>p.3 CO1 of Table.2 is changed from GRT155R71H104ME14D to GRM31CC81E226KE11L. Changed from "Capacitor, 50V, ±10%" to "Capacitor, 25V, ±20%".</p> <p>p.3 LX of Table.2 is changed from CLD5030NIT-220M-D to CLF5030NIT-220M-D.</p> <p>p.3 CIN1 of Table.2 is changed from GRAM21BC71H475KE11 to GRM21BC71H475KE11L.</p> <p>p.3 CIN3 of Table.2 is changed from GRM155R71H104KE14 to GRM155R71H104KE14D.</p> <p>p.3 Add comment. "Recommended parts are selected from those products and information available at the time this user's guide (Rev.002) was released. If supply conditions change and parts are not available, use similar parts."</p> <p>p.1 Changed comment." <i>(Note 1)</i> Restricted by Minimum duty cycle. (About the restriction of input/output voltage by minimum duty cycle, refer to p.5 of the datasheet Rev.001)" to "<i>(Note 1)</i> Restricted by Minimum duty cycle. (About the restriction of input/output voltage by minimum duty cycle, refer to p.5 of the datasheet)"</p> <p>p.2 Changed comment. "power supply's VCC pin" to "power supply's positive pin".</p> <p>p.3 Changed comment. "Please refer to the data sheet p39" to "Please refer to item 9 of the data sheet page 3"</p> <p>p.5 Changed comment. "Output Current: IOUT" to "Load Current: IOUT"</p>

