

Switching Regulator Series

Buck Converter with Integrated FET BD9G201EFJ-M EVK

BD9G201EFJ-EVK-001 (12V → 5V, 1.5A)

Introduction

This user's guide will provide the steps necessary to operate the BD9G201EFJ-EVK-001 and evaluate ROHM's BD9G201EFJ-M 1channel Buck DC/DC converter. Component selection, operating procedures and application data are included.

Description

This EVK has been developed for ROHM's non-synchronous buck DC/DC converter customers evaluating BD9G201EFJ-M. While the BD9G201EFJ-M accepts a power supply input range of 4.5V to 42V, and generates output voltages from 1V to VCC^(Note 1), this EVK is setup for the input voltage range of 10V to 42V and a fixed output of 5V can be produced. The IC has internal 140mΩ N-channel MOSFET and the operating frequency is fixed 300kHz. A fixed Soft Start circuit prevents inrush current during startup along with UVLO (under voltage lock out) and TSD (thermal shutdown detection), OCP (over current protection) protection circuits. The under voltage lock out and hysteresis can be set by external resistor using EN pin. EN pin allows for simple ON/OFF control of the IC to reduce standby current consumption. In addition, it has a synchronization function with an external clock that provides noise management.

^(Note 1) Restricted by Maximum duty cycle. (About the restriction of input/output voltage by maximum duty cycle, refer to p.10 of the datasheet Rev.001)

Application

- General consumer devices with 12V/24V lines
- Automotive applications (Audio system, Navigation system, etc)
- Industrial distributed-power applications
- Entertainment equipment

Operating Limits

Parameter	Min	Typ	Max	Units	Conditions
Input Voltage	10	12	42	V	
Output Voltage		5.0		V	
Output Current Range			1.5	A	
Operating Frequency		300		kHz	
Maximum Efficiency		93		%	I _o = 1A
UVLO Detect Voltage		5.8		V	VCC sweep down
UVLO Release Voltage		6.9		V	VCC sweep up

EVK

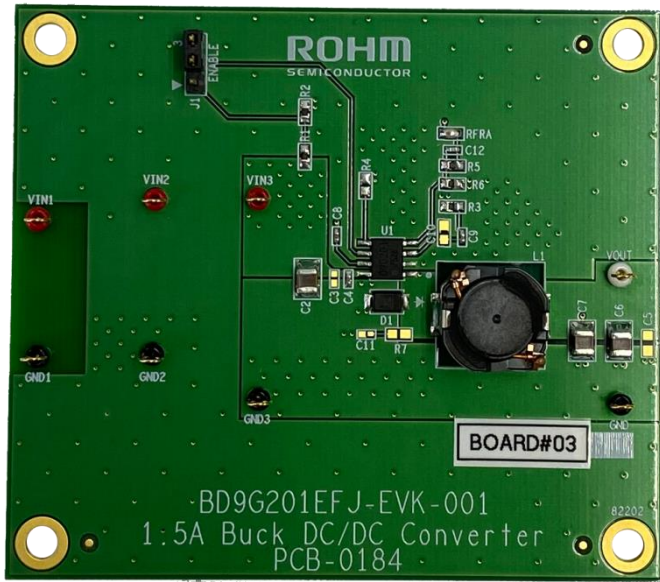

Figure 1. BD9G201EFJ-EVK-001(Top View)

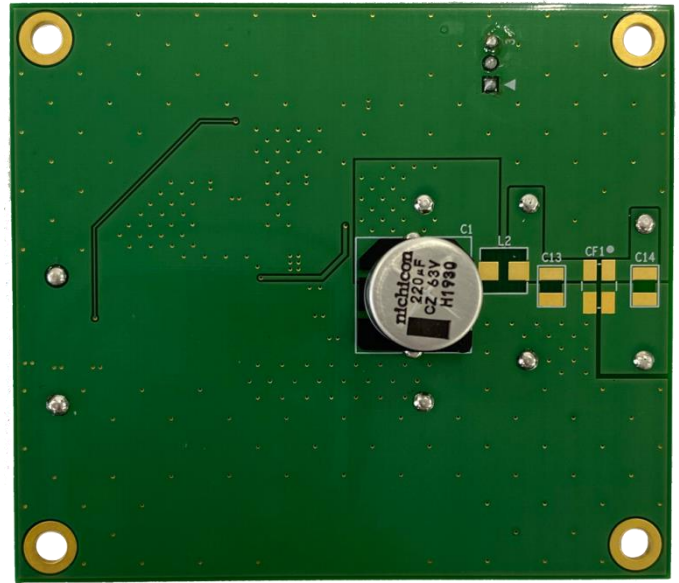

Figure 2. BD9G201EFJ-EVK-001(Bottom View)

EVK Schematic

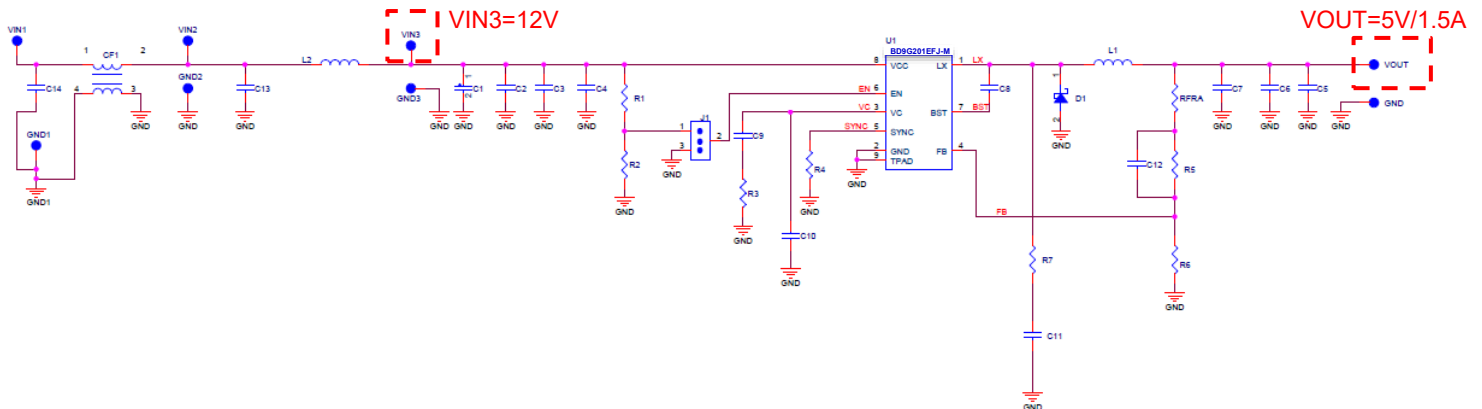

Figure 3. BD9G201EFJ-EVK-001 Schematic

The input/output pins are in the broken line (VIN3 pin and VOUT pin) in Figure 2.

Operating Procedure

Below is the procedure to operate the EVK.

1. Turn off the power supply and connect power supply's GND pin to the GND3 pin of the EVK.
2. Connect the power supply's VCC pin to the VIN3 pin of the EVK.
3. Check if the shunt jumper of J1 is at position ON (Pin 2 connect to Pin 1, the EN pin of IC U1 is pulled high)
4. Check if the electronic load is turned off and connect the electronic load to the VOUT pin and the GND pin of the EVK.
5. Connect the voltmeter to the VOUT pin and the GND pin of the EVK.
6. Turn on the power supply and check if the measured value of the voltmeter is 5V.
7. Turn on the electronic load.

Notes:

The board does not support hot plugging protection. Do not perform hot plugging on this board.

BOM

Below is a table with the bill of materials.

Table 1. Bill of Materials

Quantity	Reference Designator	Part Number	Manufacturer	Value	Description [Unit: inch(mm)]
IC					
1	U1	BD9G201EFJ-M	Rohm	-	Buck DC/DC
Capacitor					
1	C1	UCZ1J221MNQ1MS	Nichicon	220 μ F	Capacitor, 63V, \pm 20%, 5454(13.6 x 13.6)
1	C2	GCM32EC71H106KA03	Murata	10 μ F	Capacitor, 50V, X7S, \pm 10%, 1210(3225)
1	C3	-	-	-	Open
1	C4	GCM155R71H104KE02	Murata	0.1 μ F	Capacitor, 50V, X7R, \pm 10%, 0402(1005)
1	C5	-	-	-	
1	C6	GCM32EC71A476KE02	Murata	47 μ F	Capacitor, 10V, X7S, \pm 10%, 1210(3225)
1	C7	GCM32EC71A476KE02	Murata	47 μ F	Capacitor, 10V, X7S, \pm 10%, 1210(3225)
1	C8	GCM155R71E104KE02	Murata	0.1 μ F	Capacitor, 50V, X7R, \pm 10%, 0402(1005)
1	C9	GCM155R71H102KA37	Murata	1000pF	Capacitor, 50V, X7R, \pm 10%, 0402(1005)
1	C10	-	-	-	Open
1	C11	-	-	-	Open
1	C12	GCM1555C1H180JA16	Murata	18pF	Capacitor, 50V, X7R, \pm 5%, 0402(1005)
1	C13	-	-	-	Open
1	C14	-	-	-	Open
Resistor					
1	R1	MCR03EZPD1103	Rohm	110k Ω	Resistor, 50V, 0.1W, \pm 0.5%, 0603(1608)
1	R2	MCR03EZPD4302	Rohm	43k Ω	Resistor, 50V, 0.1W, \pm 0.5%, 0603(1608)
1	R3	MCR03EZPFX1502	Rohm	15k Ω	Resistor, 50V, 0.1W, \pm 1%, 0603(1608)
1	R4	-	-	-	Open
1	R5	MCR03EZPD4303	Rohm	430k Ω	Resistor, 50V, 0.1W, \pm 0.5%, 0603(1608)
1	R6	MCR03EZPD8202	Rohm	82k Ω	Resistor, 50V, 0.1W, \pm 0.5%, 0603(1608)
1	R7	-	-	-	Open
1	RFRA	-	-	-	Short
Diode					
1	D1	RBR3LAM60B	Rohm	-	Diode, 60V, 5A, 1910(4725)
Inductor					
1	L1	CLF12577NIT-220M-D	TDK	22 μ H	Inductor, 4.3A max, \pm 20%, 4949(12.8 x 12.5)
1	L2	-	-	-	-
Common Mode Filter					
1	CF1	-	-	-	-

Board Layout

EVK PCB information

Number of Layers	Material	Board Size	Copper Thickness
4	FR-4 High TG	80mm x 70mm x 1.6mmt	2oz (70μm)

Followings are the layout of BD9G201EFJ-EVK-001

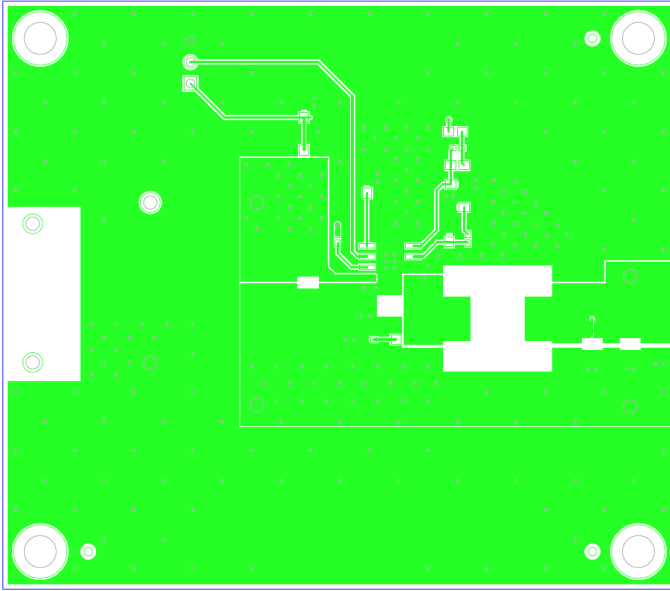

Figure 4. Top Layer Layout
(Top View)

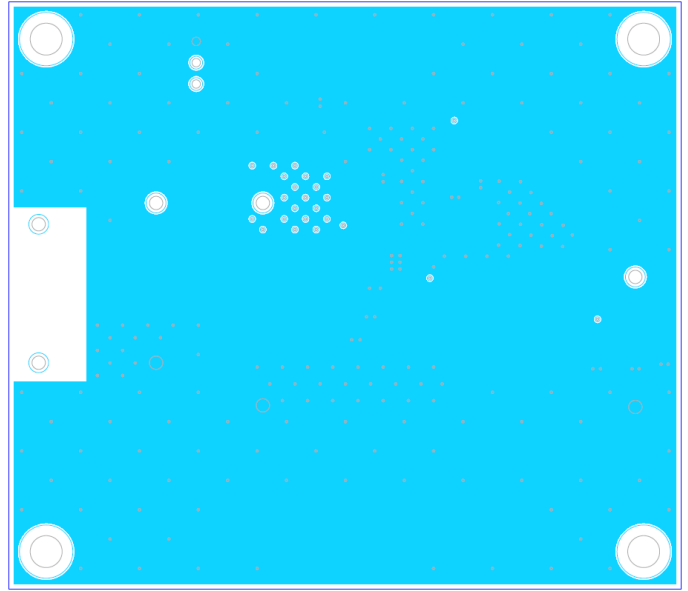

Figure 5. Middle1 Layer Layout
(Top View)

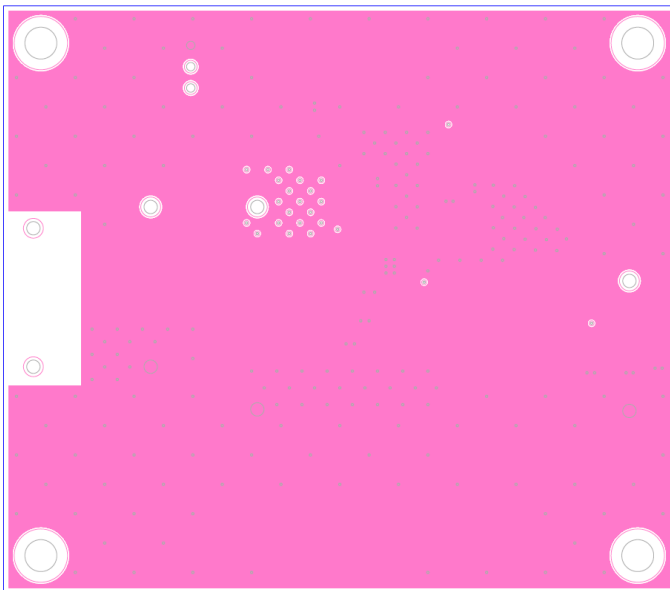

Figure 6. Middle2 Layer Layout
(Top View)

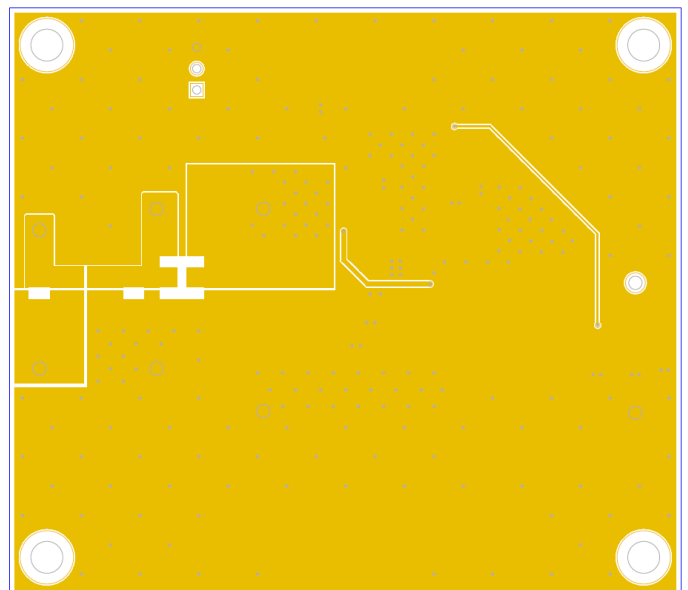

Figure 7. Bottom Layer Layout
(Top View)

Reference Application Data

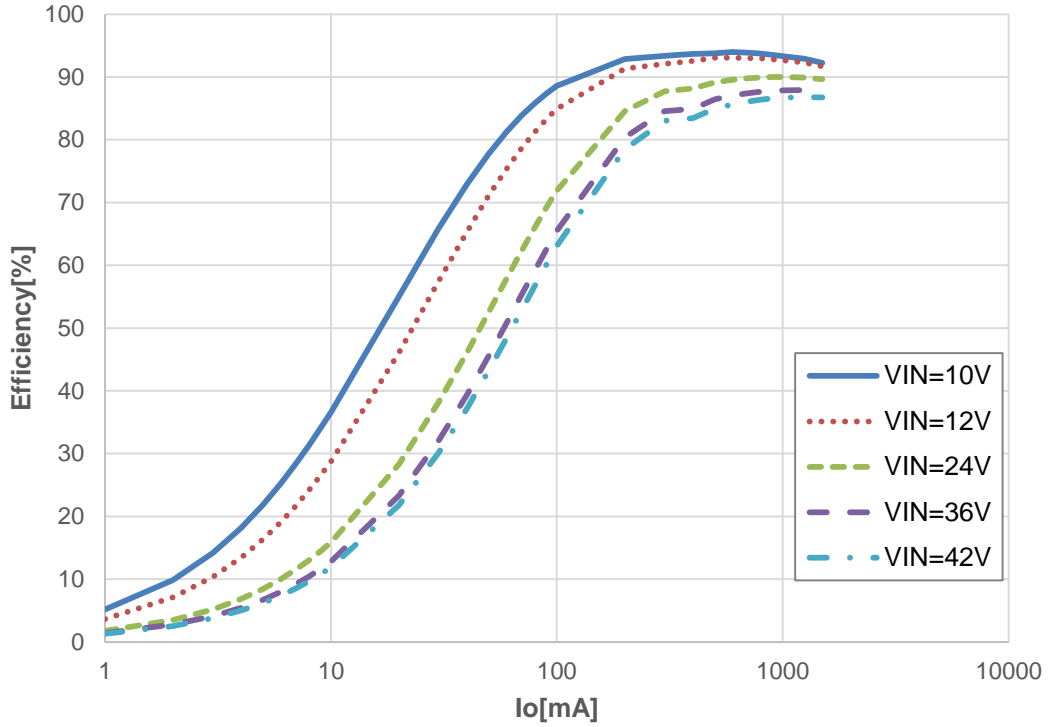

Figure 8. Efficiency vs Load Current (VOUT=5V)

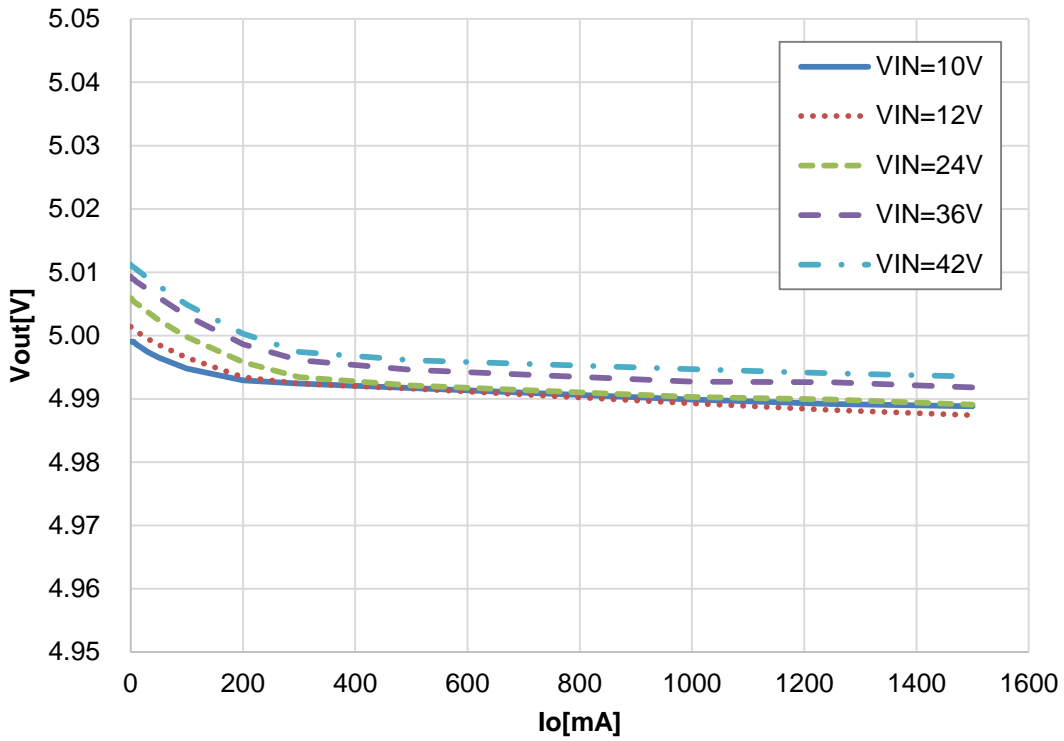

Figure 9. Load Regulation (VIN=12V, VOUT=5V)

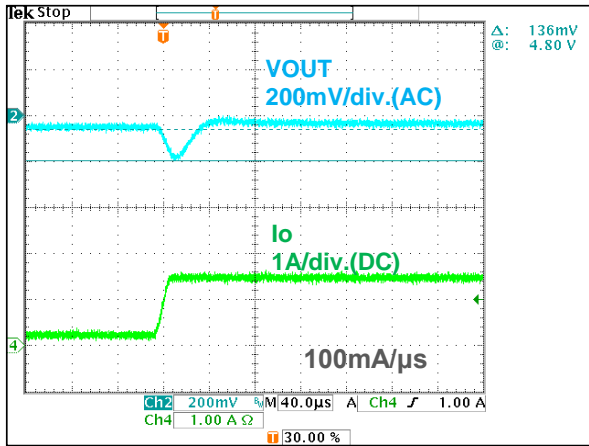

Figure 10. Transient Load Response
(VIN=12V, Io=0.25A → 1.5A)

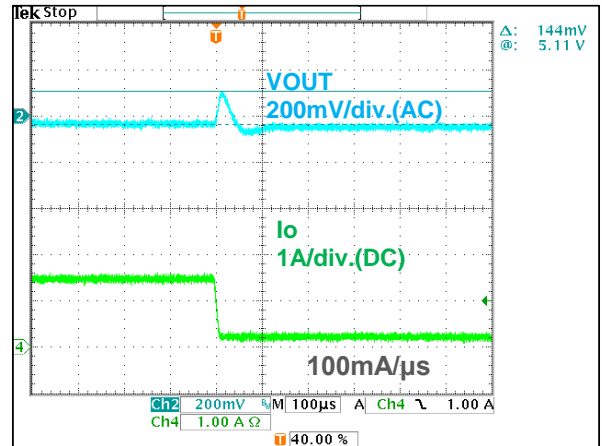

Figure 11. Transient Load Response
(VIN=12V, Io=1.5A → 0.25A)

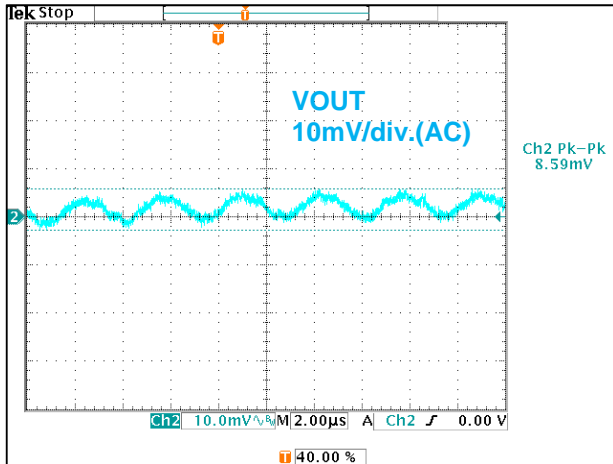

Figure 12. Output Ripple Voltage
(VIN=12V, Io=0A)

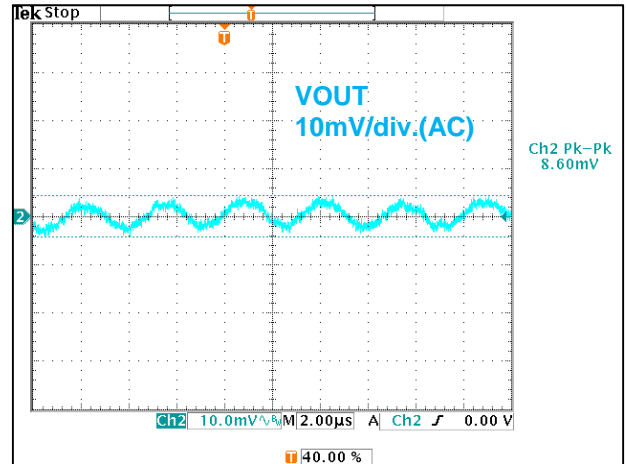

Figure 13. Output Ripple Voltage
(VIN=12V, Io=1.5A)

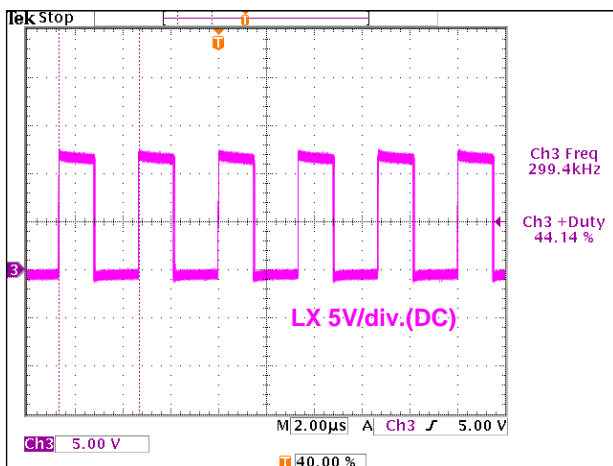

Figure 14. Switching Waveform
(VIN=12V, Io=1.5A)

Revision History

Date	Revision Number	Description
23. Jun. 2020	001	Initial release

Notes

- 1) The information contained herein is subject to change without notice.
- 2) Before you use our Products, please contact our sales representative and verify the latest specifications :
- 3) Although ROHM is continuously working to improve product reliability and quality, semiconductors can break down and malfunction due to various factors.
Therefore, in order to prevent personal injury or fire arising from failure, please take safety measures such as complying with the derating characteristics, implementing redundant and fire prevention designs, and utilizing backups and fail-safe procedures. ROHM shall have no responsibility for any damages arising out of the use of our Products beyond the rating specified by ROHM.
- 4) Examples of application circuits, circuit constants and any other information contained herein are provided only to illustrate the standard usage and operations of the Products. The peripheral conditions must be taken into account when designing circuits for mass production.
- 5) The technical information specified herein is intended only to show the typical functions of and examples of application circuits for the Products. ROHM does not grant you, explicitly or implicitly, any license to use or exercise intellectual property or other rights held by ROHM or any other parties. ROHM shall have no responsibility whatsoever for any dispute arising out of the use of such technical information.
- 6) The Products specified in this document are not designed to be radiation tolerant.
- 7) For use of our Products in applications requiring a high degree of reliability (as exemplified below), please contact and consult with a ROHM representative : transportation equipment (i.e. cars, ships, trains), primary communication equipment, traffic lights, fire/crime prevention, safety equipment, medical systems, servers, solar cells, and power transmission systems.
- 8) Do not use our Products in applications requiring extremely high reliability, such as aerospace equipment, nuclear power control systems, and submarine repeaters.
- 9) ROHM shall have no responsibility for any damages or injury arising from non-compliance with the recommended usage conditions and specifications contained herein.
- 10) ROHM has used reasonable care to ensure the accuracy of the information contained in this document. However, ROHM does not warrants that such information is error-free, and ROHM shall have no responsibility for any damages arising from any inaccuracy or misprint of such information.
- 11) Please use the Products in accordance with any applicable environmental laws and regulations, such as the RoHS Directive. For more details, including RoHS compatibility, please contact a ROHM sales office. ROHM shall have no responsibility for any damages or losses resulting non-compliance with any applicable laws or regulations.
- 12) When providing our Products and technologies contained in this document to other countries, you must abide by the procedures and provisions stipulated in all applicable export laws and regulations, including without limitation the US Export Administration Regulations and the Foreign Exchange and Foreign Trade Act.
- 13) This document, in part or in whole, may not be reprinted or reproduced without prior consent of ROHM.



Thank you for your accessing to ROHM product informations.
More detail product informations and catalogs are available, please contact us.

ROHM Customer Support System

<http://www.rohm.com/contact/>