

ROHM Solution Simulator

3.5V to 40V Input, 1A Single 2.2MHz Buck DC/DC Converter for Automotive

BD9P135MUF-C / Line Response

This circuit simulate the line response of BD9P135MUF-C. You can observe the fluctuation of the output voltage when the load current is abruptly changed. You can customize the parameters of the components shown in blue, such as VIN, IOU, or peripheral components, and simulate the Line response with desired operating condition.

General Cautions

- Caution 1:* The values from the simulation results are not guaranteed. Please use these results as a guide for your design.
- Caution 2:* These model characteristics are specifically at Ta=25°C. Thus, the simulation result with temperature variances may significantly differ from the result with the one done at actual application board (actual measurement).
- Caution 3:* Please refer to the datasheet for details of the technical information.
- Caution 4:* The characteristics may change depending on the actual board design and ROHM strongly recommend to double check those characteristics with actual board where the chips will be mounted on.

1 Simulation Schematic

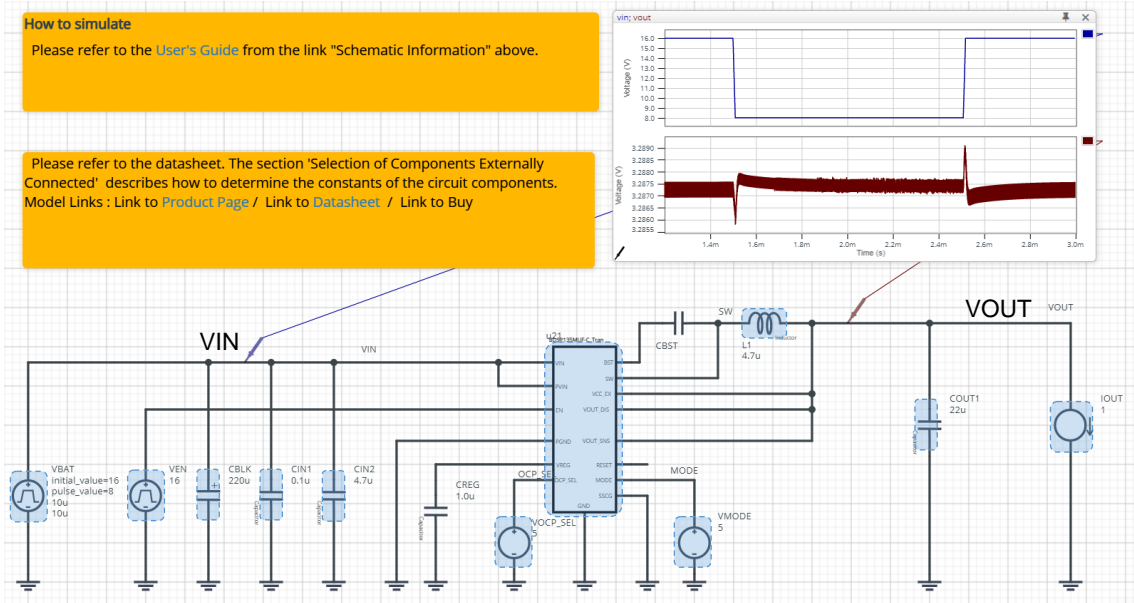

Figure 1. Simulation Schematic

2 How to simulate

The simulation settings, such as simulation time or convergence options, are configurable from the 'Simulation Settings' shown in Figure 2, and Table 1 shows the default setup of the simulation.

In case of simulation convergence issue, you can change advanced options to solve. Default statement in 'Manual Options' sets the time to start saving the result to 1.2ms. You can modify or delete it.

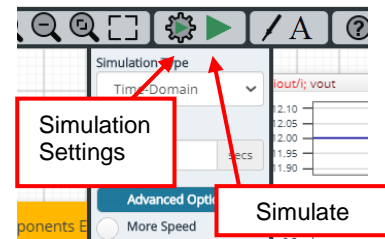

Figure 2. Simulation Settings and execution

Table 1. Simulation settings default setup

Parameters	Default	Note
Simulation Type	Time-Domain	Do not change Simulation Type
End Time	3ms	
Advanced options	Balanced	
	Convergence Assist	
Manual Options	“.tran 0 3m 1.2m”	

3 Simulation Conditions

Table 2. List of the simulation condition parameters

Instance Name	Type	Parameters	Default Value	Variable Range		Units
				Min	Max	
VBAT	Voltage Source	Initial_value	16	3.5	40	V
		Pulse_value	8	3.5	40	V
		ramptime_initial_to_pulse	10	No constraint ^(Note1)		μs
		ramptime_pulse_to_initial	10	No constraint ^(Note1)		μs
		Start_delay	1.5	-		ms
		Pulse_width	1.0	-		ms
		Period	3.0	-		ms
VEN	Voltage Source	Pulse_value	16	Use the same value as the voltage_level of VBAT		V
VOCP_SEL	Voltage Source	voltage_level	5	0: Max output current =0.5A, or 5: Max output current=1.0A		V
VMODE	Voltage Source	voltage_level	5	0: Auto mode, or 5: FPWM mode		V
IOUT	Current source	Current_level	1	0	1	A

(Note 1) This is a constraint of the simulation settings and does not guarantee the operation of the IC.

3.1 VBAT parameter setup

Figure 3 shows how the VBAT parameters correspond to the VIN stimulus waveform.

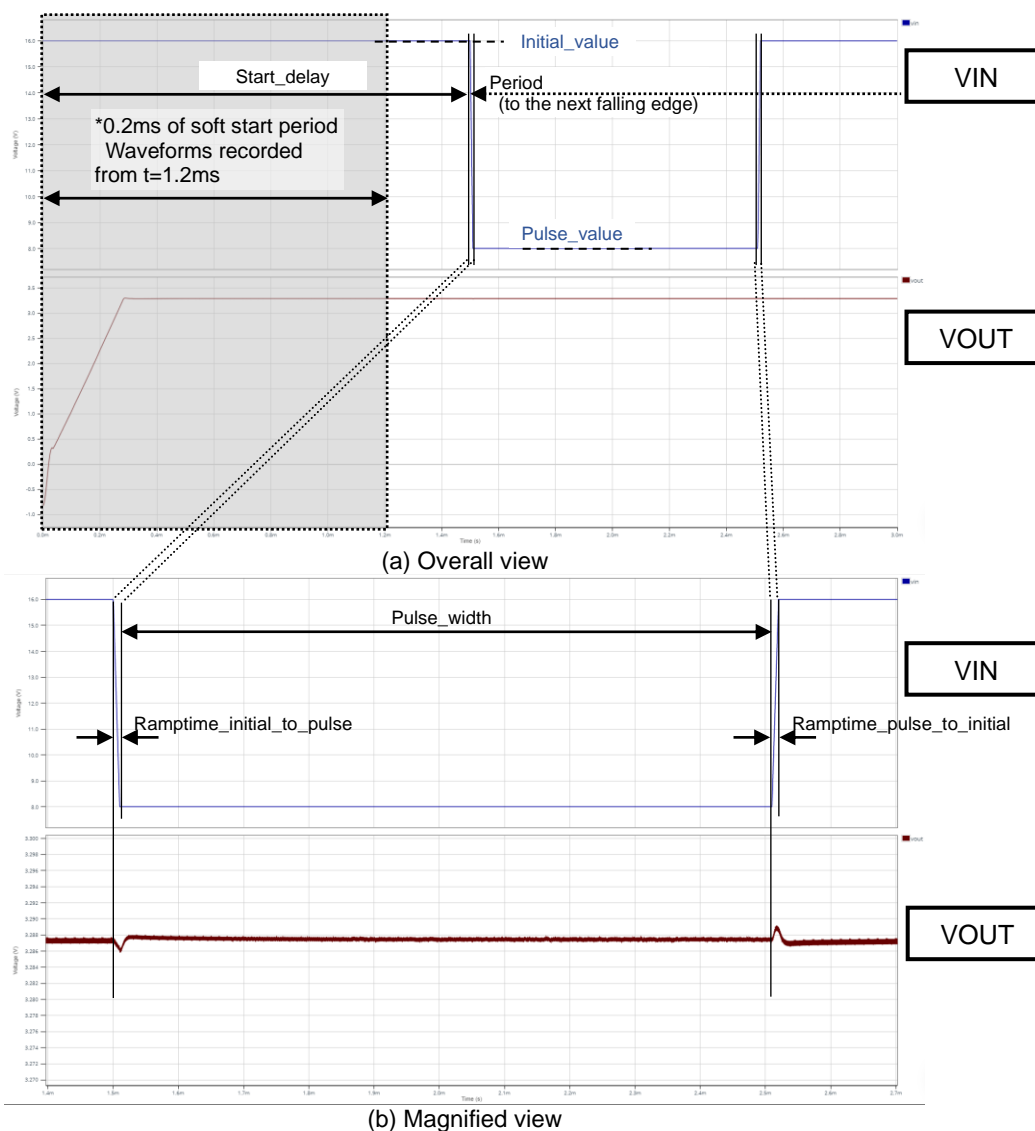

Figure 3. VIN parameters and its waveform

4 BD9P135MUF-C_Tran model

Table 3 and Table 4 shows the model terminal function implemented. Note that BD9P135MUF-C_Tran is the behavior model for its load/line response operation, and no protection circuits or the functions not related to the purpose are not implemented.

Table 3. BD9P135MUF-C_Tran model terminals used for the simulation

Terminals	Description
EN	Enable input
VIN	Power supply input
PVIN	Power supply input
PGND	Power ground
SW	Switching node
OCP_SEL	Over current selector input
MODE	PWM mode selector input
GND	Ground
VOUT_SNS	Phase compensation.
VREG	3.3V output for internal circuit.

Table 4. BD9P135MUF-C_Tran model terminals NOT used for the simulation

Terminals	Description
EN	Input is ignored (always enable)
BST	Input is ignored (Bootstrap not implemented)
SSCG	Input is ignored (SSCG not implemented)
RESET	The function is not implemented
VOUT_DIS	Input is ignored
VCC_EX	Input is ignored (function not implemented)

(Note 2) This model is not compatible with the influence of ambient temperature.

(Note 3) This model is not compatible with the external synchronization function.

(Note 4) Use the simulation results only as a design guide and the data reported herein is not a guaranteed value.

4.1 Parameter TSS

BD9P135MUF-C_Tran model has the property 'TSS', which is the soft start time described in page 7 of the datasheet. The product has 3ms (typical) of the startup time of the output voltage. You can short cut the soft start by changing TSS value. The default TSS value is set to 0.2ms in this simulation and you can modify the value in the property editor.

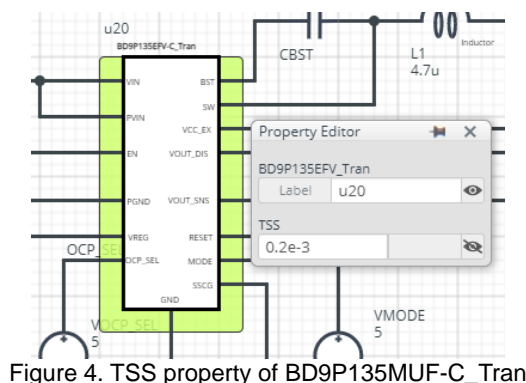

Figure 4. TSS property of BD9P135MUF-C_Tran

5 Peripheral Components

5.1 Bill of Material

Table 5 shows the list of components used in the simulation schematic. Each of the capacitor and inductor has the parameters of equivalent circuit shown below. The default value of equivalent components are set to zero except for the parallel resistance of L1. You can modify the values of each component.

Table 5. List of capacitors used in the simulation circuit

Type	Instance Name	Default Value	Units
Capacitor	CBLK	220	μF
	CIN1	0.1	μF
	CIN2	4.7	μF
	CREG	1.0	μF
	COUT1	22	μF
Inductor	L1	4.7	μH

5.2 Capacitor Equivalent Circuits

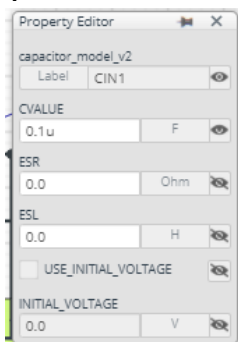

(a) Property editor

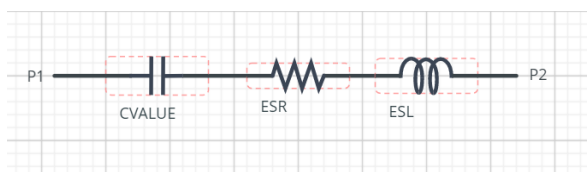

(b) Equivalent circuit

Figure 5. Capacitor property editor and equivalent circuit

5.3 Inductor Equivalent Circuits

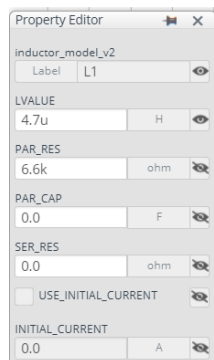

(a) Property editor

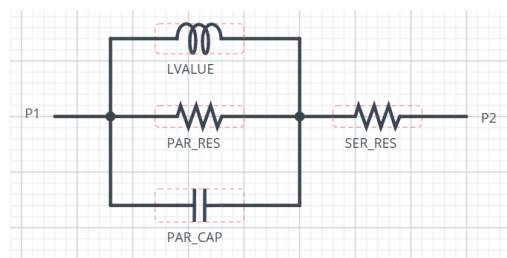

(b) Equivalent circuit

Figure 6. Inductor property editor and equivalent circuit

The default value of PAR_RES is 6.6kohm.

(Note 5) These parameters can take any positive value or zero in simulation but it does not guarantee the operation of the IC in any condition. Refer to the datasheet to determine adequate value of parameters.

6 Link to the product information and tools

6.1 Product webpage link:

<https://www.rohm.com/products/power-management/switching-regulators/integrated-fet/buck-converters-synchronous/bd9p135muf-c-product>

6.2 Related documents

The application notes are available from 'Documentation' tab of the product page.

6.3 Design assist tools are available from 'Tools' tab of the product page.

The Circuit constant calculation sheet is useful for Febiding the application circuit constants.

Notes

- 1) The information contained herein is subject to change without notice.
- 2) Before you use our Products, please contact our sales representative and verify the latest specifications :
- 3) Although ROHM is continuously working to improve product reliability and quality, semiconductors can break down and malfunction due to various factors.
Therefore, in order to prevent personal injury or fire arising from failure, please take safety measures such as complying with the derating characteristics, implementing redundant and fire prevention designs, and utilizing backups and fail-safe procedures. ROHM shall have no responsibility for any damages arising out of the use of our Products beyond the rating specified by ROHM.
- 4) Examples of application circuits, circuit constants and any other information contained herein are provided only to illustrate the standard usage and operations of the Products. The peripheral conditions must be taken into account when designing circuits for mass production.
- 5) The technical information specified herein is intended only to show the typical functions of and examples of application circuits for the Products. ROHM does not grant you, explicitly or implicitly, any license to use or exercise intellectual property or other rights held by ROHM or any other parties. ROHM shall have no responsibility whatsoever for any dispute arising out of the use of such technical information.
- 6) The Products specified in this document are not designed to be radiation tolerant.
- 7) For use of our Products in applications requiring a high degree of reliability (as exemplified below), please contact and consult with a ROHM representative : transportation equipment (i.e. cars, ships, trains), primary communication equipment, traffic lights, fire/crime prevention, safety equipment, medical systems, servers, solar cells, and power transmission systems.
- 8) Do not use our Products in applications requiring extremely high reliability, such as aerospace equipment, nuclear power control systems, and submarine repeaters.
- 9) ROHM shall have no responsibility for any damages or injury arising from non-compliance with the recommended usage conditions and specifications contained herein.
- 10) ROHM has used reasonable care to ensure the accuracy of the information contained in this document. However, ROHM does not warrants that such information is error-free, and ROHM shall have no responsibility for any damages arising from any inaccuracy or misprint of such information.
- 11) Please use the Products in accordance with any applicable environmental laws and regulations, such as the RoHS Directive. For more details, including RoHS compatibility, please contact a ROHM sales office. ROHM shall have no responsibility for any damages or losses resulting non-compliance with any applicable laws or regulations.
- 12) When providing our Products and technologies contained in this document to other countries, you must abide by the procedures and provisions stipulated in all applicable export laws and regulations, including without limitation the US Export Administration Regulations and the Foreign Exchange and Foreign Trade Act.
- 13) This document, in part or in whole, may not be reprinted or reproduced without prior consent of ROHM.



Thank you for your accessing to ROHM product informations.
More detail product informations and catalogs are available, please contact us.

ROHM Customer Support System

<http://www.rohm.com/contact/>