

## Secondary Buck DC/DC Converter Series

# Single Synchronous Buck DC/DC Converter For Automotive

## BD9S231NUX-C Evaluation Board

BD9S231NUX-TSB-001 (2.7V to 5.5V Input, 2A)

### Introduction

This user's guide will provide the necessary steps to operate the Evaluation Board of ROHM's BD9S231NUX-C Buck DC/DC converter. This includes the external parts, operating procedures and application data.

### Description

This Evaluation Board was developed for ROHM's single Synchronous buck DC/DC converter BD9S231NUX-C.

BD9S231NUX-C is a synchronous buck DC/DC converter with built-in low On Resistance power MOSFETs.

BD9S231NUX-C accepts a power supply input range of 2.7V to 5.5V and generates a maximum output current of 2A.

BD9S231NUX-C generates an output voltage range of 0.8V to VIN using external resistors. BD9S231NUX-C is a current mode control DC/DC Converter and features high-speed transient response.

### Application

Automotive Equipment

Other Electronic Equipment

### Recommended Operating Conditions

Table 1. Recommended Operating Conditions

Parameter	Min	Typ	Max	Units	Conditions
Input Voltage	2.7	-	5.5	V	
Output Voltage for BD9S231NUX-C (Note1)	0.8	-	VIN	V	
Output Current Range	-	-	2.0	A	
Switching Frequency	-	2.2	-	MHz	
Maximum Efficiency (Vo=1.8V)	-	88.7	-	%	VIN=5.0V, Io=0.57A, Ta=25°C
Maximum Efficiency (Vo=1.8V)	-	91.4	-	%	VIN=3.3V, Io=0.34A, Ta=25°C
Maximum Efficiency (Vo=1.15V)	-	84.3	-	%	VIN=5.0V, Io=0.53A, Ta=25°C
Maximum Efficiency (Vo=1.15V)	-	87.6	-	%	VIN=3.3V, Io=0.34A, Ta=25°C

(Note 1) Although the minimum output voltage is configurable up to 0.8 V, it may be limited by the SW min ON pulse width.

SW Minimum ON Time that BD9S231NUX-C can output stably in the entire load range is 80ns. Use the value to calculate the

input and output conditions that satisfy the equation of  $80[\text{ns}] \leq \frac{V_{out}}{V_{IN} \times f_{SW}}$ .

## Evaluation Board

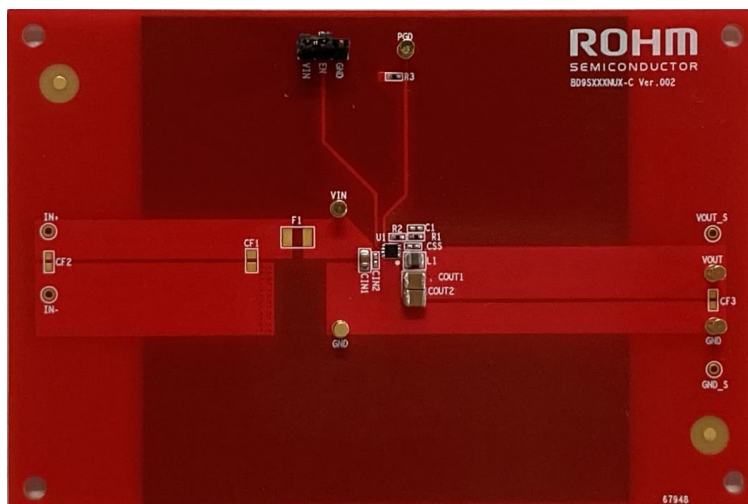

Figure 1. Evaluation Board Top View

(Note) The size of COUT Capacitor is 3216, it is a little bigger than the size of the land pattern on the PCB.

## Evaluation Board Schematic

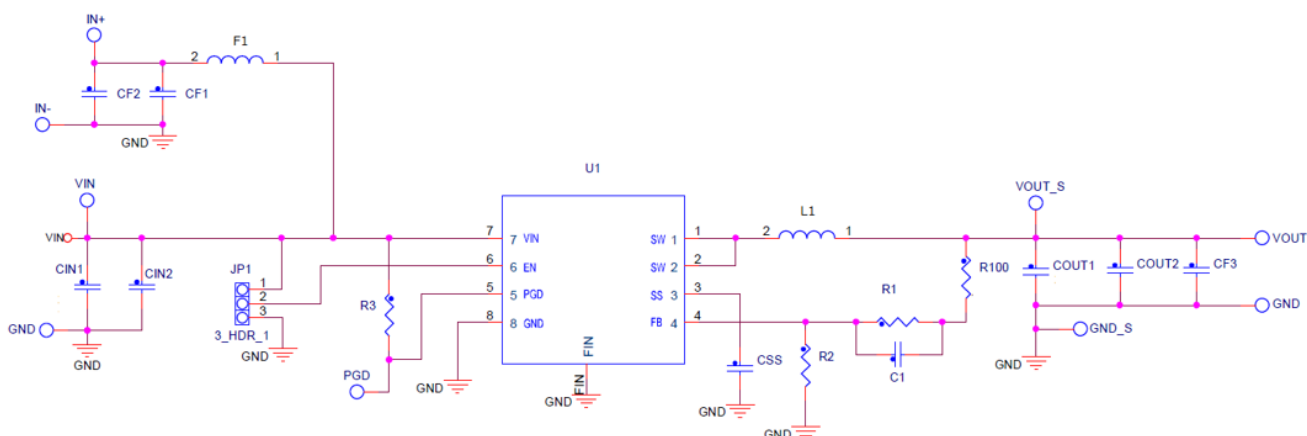

Figure 2. Circuit Diagram

## Operating Procedure

1. Turn off EN and connect the GND terminal of the power supply to the GND terminal of Evaluation Board.
2. Connect power supply to the VIN pin of the Evaluation Board.
3. Connect the load to the Evaluation Board's VOUT and GND terminals. When using an electronic load, connect with the load turned off.
4. Connect a voltmeter to the Evaluation Board's VOUT and GND terminals.
5. Turn on the Power supply of VIN. Turn ON the switch of EN terminal.
6. Make sure that the voltmeter is set to measure voltage.
7. Turn on the electronic load.

(Caution) This Evaluation Board does not support hot plug. Do not perform hot plug test.

(Note) If EN=High (EN short to VIN) before Power ON, the turn ON and turn OFF is controlled by VIN only.

## Pin Configuration

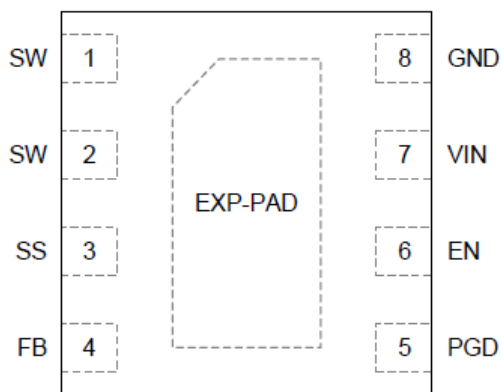

(TOP VIEW)

Figure 3. Pin Configuration

## Pin Description

Table 2. VIN and EN Terminal Description

VIN PIN	EN PIN	VOUT
$VIN \geq 2.55V(TYP)$	$EN \geq 1.0V$	Start up with Soft Start
$VIN \geq 2.55V(TYP)$	$EN \leq 0.5V$	Shutdown
$VIN \leq 2.45V(TYP)$	-	Shutdown

(Note) PGD function is enabled after soft start is completed.

Table 3. EN and PGD Terminal Description

EN PIN	UVLO	TSD	Power Good Function	Power Good Output
$EN \geq 1.0V$	Release	Undetected	Enable	High / Low
		Detected		Low
$EN \leq 0.5V$	-	-	Disable	Low
		-		Low

Table 4. FB and PGD Terminal Description

FB PIN	Power Good Output
In the range of $0.8V(TYP) \pm 7\%$	HIGH
Out the range of $0.8V(TYP) \pm 10\%$	LOW

(Note) PGD pin is an output of open drain MOSFET, and the PGD pin is pulled down with impedance of  $60\Omega$  (TYP). It is recommended to use a pull-up resistor of  $2k\Omega$  to  $100k\Omega$  for the power source.

Table 5. FB and Protection Description

EN Pin	FB PIN	Protection	Protection item
$EN \geq 1.0V$	$FB \geq 0.6V(TYP)$	Enabled	-
	$FB \leq 0.56V(TYP)$ and remains 1ms(TYP)		SCP
	$FB \geq 0.88V(TYP)$		OVP
$EN \leq 0.5V$	-	Disabled	-

(Note) When the FB pin voltage has fallen to 0.56 V (TYP) or less and remained there for 1ms (TYP), SCP stops the operation for 14ms (TYP) and subsequently initiates a restart.

When the FB pin voltage becomes over or equal to 0.88 V (TYP), which is Output Over Voltage Protection Detection Voltage, the MOSFETs on the output stage are turned OFF to prevent the increase in the output voltage.

## Parts list

Table 6. Parts list (VOUT=1.0V, VIN=5.0V,3.3V)

No	Package	Parameters	Part Name (Series)	Type	Manufacturer
L1	2520	1.0 $\mu$ H	TFM252012ALMA1R0M	Inductor	TDK
COUT1	3216	22 $\mu$ F, X7R, 6.3 V	GCM31CR70J226K	Ceramic Capacitor	Murata
COUT2	3216	22 $\mu$ F, X7R, 6.3 V	GCM31CR70J226K	Ceramic Capacitor	Murata
CIN1	2012	10 $\mu$ F, X7R, 10 V	GCM21BR71A106K	Ceramic Capacitor	Murata
R100	-	SHORT	-	-	-
R1 (Note1)	1005	7.5 k $\Omega$ , 1 %, 1/16 W	MCR01MZPF7501	Chip Resistor	ROHM
R2 (Note1)	1005	30 k $\Omega$ , 1 %, 1/16 W	MCR01MZPF3002	Chip Resistor	ROHM
R3	1005	100 k $\Omega$ , 1 %, 1/16 W	MCR01MZPF1003	Chip Resistor	ROHM
CSS	-	-	-	-	-
C1	-	-	-	-	-
COUT2	-	-	-	-	-
CIN2	-	-	-	-	-
CF1	-	-	-	-	-
CF2	-	-	-	-	-
F1	-	-	-	-	-
CF3	-	-	-	-	-

Table 7. Parts list (VOUT=1.15V, VIN=5.0V,3.3V)

No	Package	Parameters	Part Name (Series)	Type	Manufacturer
L1	2520	1.0 $\mu$ H	TFM252012ALMA1R0M	Inductor	TDK
COUT1	3216	22 $\mu$ F, X7R, 6.3 V	GCM31CR70J226K	Ceramic Capacitor	Murata
COUT2	3216	22 $\mu$ F, X7R, 6.3 V	GCM31CR70J226K	Ceramic Capacitor	Murata
CIN1	2012	10 $\mu$ F, X7R, 10 V	GCM21BR71A106K	Ceramic Capacitor	Murata
R100	-	SHORT	-	-	-
R1 (Note1)	1005	27 k $\Omega$ , 1 %, 1/16 W	MCR01MZPF2702	Chip Resistor	ROHM
R2 (Note1)	1005	62 k $\Omega$ , 1 %, 1/16 W	MCR01MZPF6202	Chip Resistor	ROHM
R3	1005	100 k $\Omega$ , 1 %, 1/16 W	MCR01MZPF1003	Chip Resistor	ROHM
CSS	-	-	-	-	-
C1	-	-	-	-	-
COUT2	-	-	-	-	-
CIN2	-	-	-	-	-
CF1	-	-	-	-	-
CF2	-	-	-	-	-
F1	-	-	-	-	-
CF3	-	-	-	-	-

(Note) Please increase COUT1 and COUT2 to 47 $\mu$ F (3225) if BD9S231NUX is used for Traveo II model of Cypress semiconductor.

Table 8. Parts list (VOUT=1.2V, VIN=5.0V,3.3V)

No	Package	Parameters	Part Name (Series)	Type	Manufacturer
L1	2520	1.0 $\mu$ H	TFM252012ALMA1R0M	Inductor	TDK
COU1	3216	22 $\mu$ F, X7R, 6.3 V	GCM31CR70J226K	Ceramic Capacitor	Murata
COU2	3216	22 $\mu$ F, X7R, 6.3 V	GCM31CR70J226K	Ceramic Capacitor	Murata
CIN1	2012	10 $\mu$ F, X7R, 10 V	GCM21BR71A106K	Ceramic Capacitor	Murata
R100	-	SHORT	-	-	-
R1 (Note1)	1005	10 k $\Omega$ , 1 %, 1/16 W	MCR01MZPF1002	Chip Resistor	ROHM
R2 (Note1)	1005	20 k $\Omega$ , 1 %, 1/16 W	MCR01MZPF2002	Chip Resistor	ROHM
R3	1005	100 k $\Omega$ , 1 %, 1/16 W	MCR01MZPF1003	Chip Resistor	ROHM
CSS	-	-	-	-	-
C1	-	-	-	-	-
COU2	-	-	-	-	-
CIN2	-	-	-	-	-
CF1	-	-	-	-	-
CF2	-	-	-	-	-
F1	-	-	-	-	-
CF3	-	-	-	-	-

Table 9. Parts list (VOUT=1.5V, VIN=5.0V,3.3V)

No	Package	Parameters	Part Name (Series)	Type	Manufacturer
L1	2520	1.0 $\mu$ H	TFM252012ALMA1R0M	Inductor	TDK
COU1	3216	22 $\mu$ F, X7R, 6.3 V	GCM31CR70J226K	Ceramic Capacitor	Murata
COU2	3216	22 $\mu$ F, X7R, 6.3 V	GCM31CR70J226K	Ceramic Capacitor	Murata
CIN1	2012	10 $\mu$ F, X7R, 10 V	GCM21BR71A106K	Ceramic Capacitor	Murata
R100	-	SHORT	-	-	-
R1 (Note1)	1005	16 k $\Omega$ , 1 %, 1/16 W	MCR01MZPF1602	Chip Resistor	ROHM
R2 (Note1)	1005	18 k $\Omega$ , 1 %, 1/16 W	MCR01MZPF1802	Chip Resistor	ROHM
R3	1005	100 k $\Omega$ , 1 %, 1/16 W	MCR01MZPF1003	Chip Resistor	ROHM
CSS	-	-	-	-	-
C1	-	-	-	-	-
COU2	-	-	-	-	-
CIN2	-	-	-	-	-
CF1	-	-	-	-	-
CF2	-	-	-	-	-
F1	-	-	-	-	-
CF3	-	-	-	-	-

Table 10. Parts list (VOUT=1.8V, VIN=5.0V,3.3V)

No	Package	Parameters	Part Name (Series)	Type	Manufacturer
L1	2520	1.0 $\mu$ H	TFM252012ALMA1R0M	Inductor	TDK
COU1	3216	22 $\mu$ F, X7R, 6.3 V	GCM31CR70J226K	Ceramic Capacitor	Murata
COU2	3216	22 $\mu$ F, X7R, 6.3 V	GCM31CR70J226K	Ceramic Capacitor	Murata
CIN1	2012	10 $\mu$ F, X7R, 10 V	GCM21BR71A106K	Ceramic Capacitor	Murata
R100	-	SHORT	-	-	-
R1 (Note1)	1005	30 k $\Omega$ , 1 %, 1/16 W	MCR01MZPF3002	Chip Resistor	ROHM
R2 (Note1)	1005	24 k $\Omega$ , 1 %, 1/16 W	MCR01MZPF2402	Chip Resistor	ROHM
R3	1005	100 k $\Omega$ , 1 %, 1/16 W	MCR01MZPF1003	Chip Resistor	ROHM
CSS	-	-	-	-	-
C1	-	-	-	-	-
COU2	-	-	-	-	-
CIN2	-	-	-	-	-
CF1	-	-	-	-	-
CF2	-	-	-	-	-
F1	-	-	-	-	-
CF3	-	-	-	-	-

(Note1)  $V_{OUT} = \frac{R1+R2}{R2} \times 0.8$  [V]

Please use R1 and R2 under the following condition in order to prevent the output from rising due to leakage current.

$$R1+R2 \leq 95\text{kohm}$$

(Note) The size of COU Capacitor is 3216, it is a little bigger than the size of the land pattern on the PCB.

(Note) CSS, C1, COU2, CIN2, CF1, CF2, F1, CF3 patterns are only optional. They can be utilized for adjusting the characteristics constants.

## Board Layout

Evaluation Board PCB information

Number of Layers	Material	Board Size	Copper Thickness
4	FR4	114.3mm x 76.2mm x 1.6mm	2oz(70μm) / 1oz (35μm) / 1oz (35μm) / 2oz(70μm)

The layout of BD9S231NUX-C is shown below.

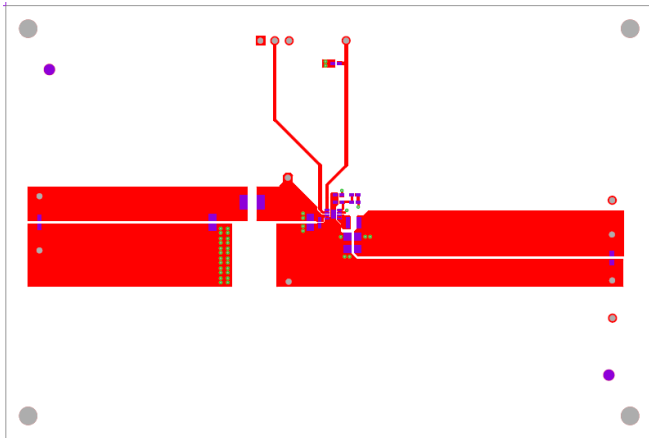

Figure 4. Top Layer Layout  
(Top View)

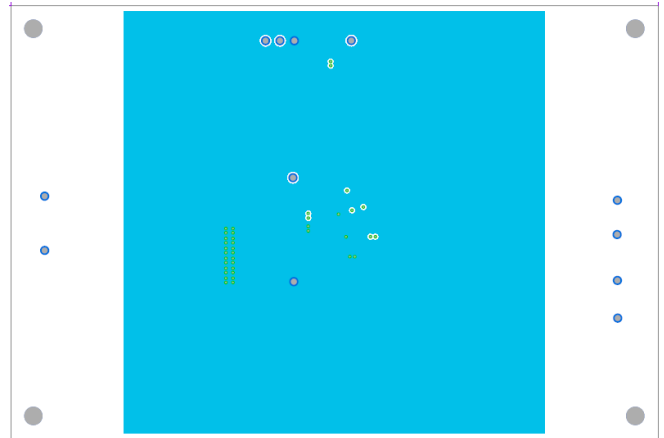

Figure 5. Middle1 Layer Layout  
(Top View)

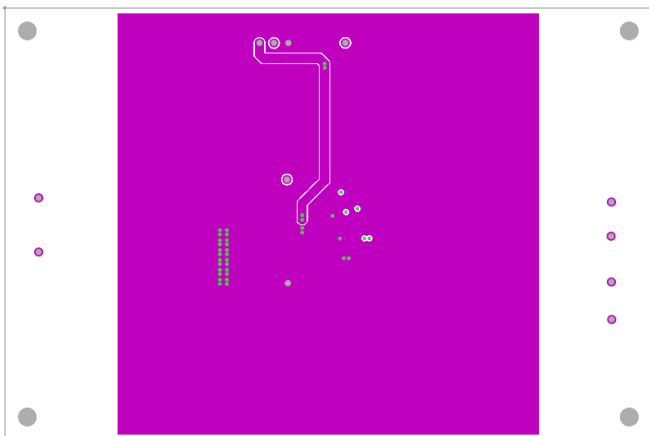

Figure 6. Middle2 Layer Layout  
(Top View)

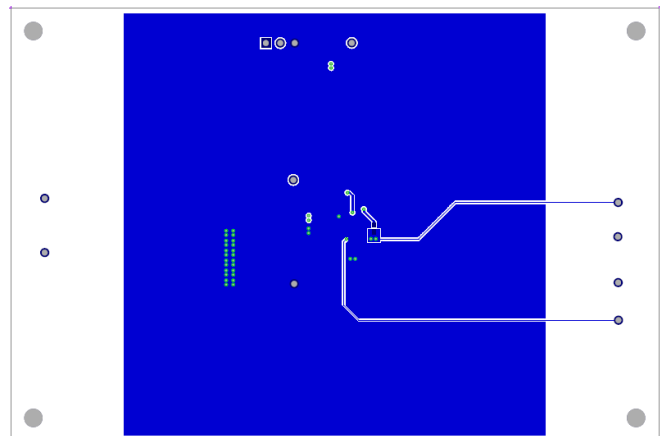

Figure 7. Bottom Layer Layout  
(Top View)



Reference application data (BD9S231NUX-C)

(VIN=VEN, VOUT=1.15V, COUT=22uFx2, Ta=25°C)

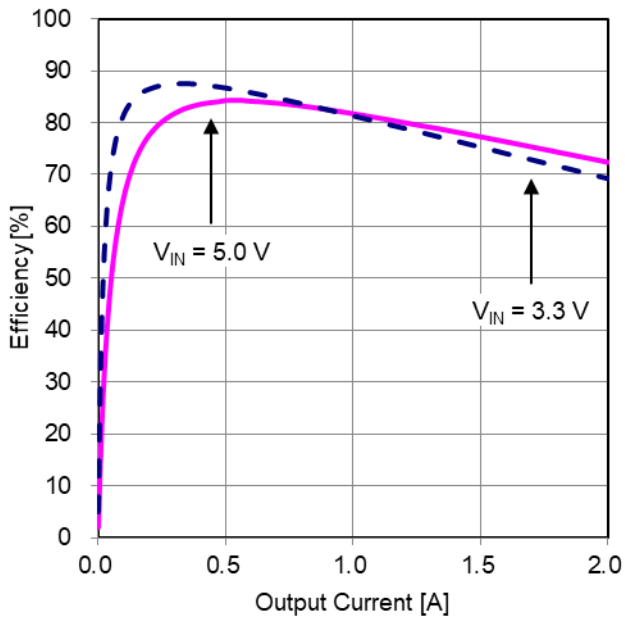

Figure 8. Efficiency vs Output Current

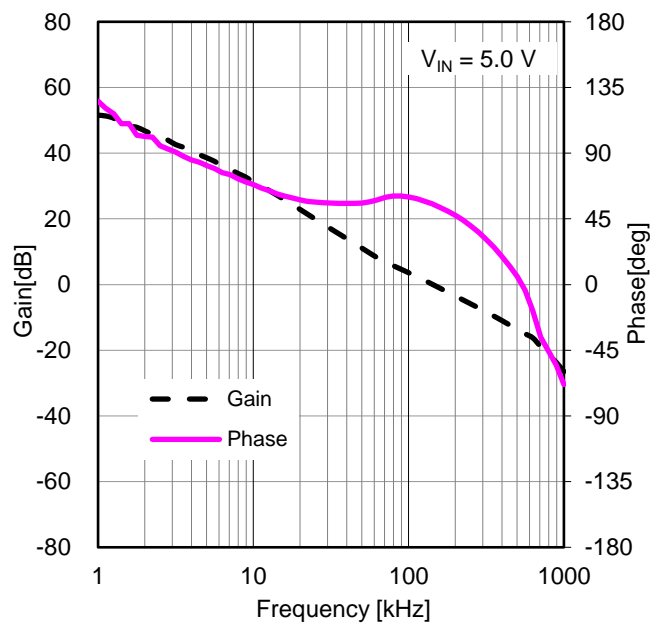

Figure 9. Frequency Characteristics  
(IOUT=2 A)

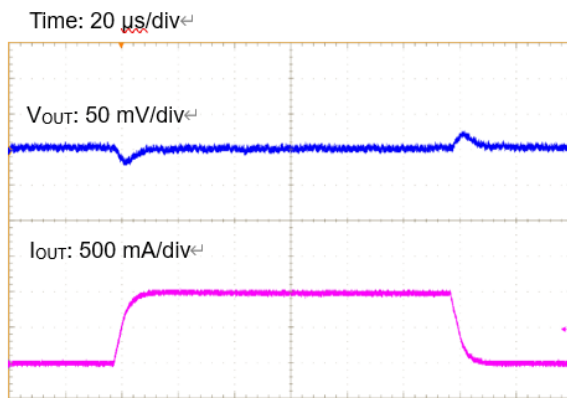

Figure 10. Load Transient Response  
(IOUT = 0 A ↔ 1 A)

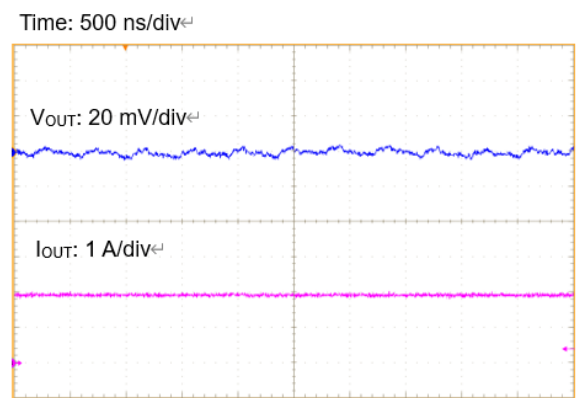

Figure 11. Output Ripple Voltage  
(IOUT = 2 A)

**Revision History**

Date	Revision Number	Description
31. Mar. 2021	01	Initial release

## Notes

- 1) The information contained herein is subject to change without notice.
- 2) Before you use our Products, please contact our sales representative and verify the latest specifications :
- 3) Although ROHM is continuously working to improve product reliability and quality, semiconductors can break down and malfunction due to various factors.  
Therefore, in order to prevent personal injury or fire arising from failure, please take safety measures such as complying with the derating characteristics, implementing redundant and fire prevention designs, and utilizing backups and fail-safe procedures. ROHM shall have no responsibility for any damages arising out of the use of our Products beyond the rating specified by ROHM.
- 4) Examples of application circuits, circuit constants and any other information contained herein are provided only to illustrate the standard usage and operations of the Products. The peripheral conditions must be taken into account when designing circuits for mass production.
- 5) The technical information specified herein is intended only to show the typical functions of and examples of application circuits for the Products. ROHM does not grant you, explicitly or implicitly, any license to use or exercise intellectual property or other rights held by ROHM or any other parties. ROHM shall have no responsibility whatsoever for any dispute arising out of the use of such technical information.
- 6) The Products specified in this document are not designed to be radiation tolerant.
- 7) For use of our Products in applications requiring a high degree of reliability (as exemplified below), please contact and consult with a ROHM representative : transportation equipment (i.e. cars, ships, trains), primary communication equipment, traffic lights, fire/crime prevention, safety equipment, medical systems, servers, solar cells, and power transmission systems.
- 8) Do not use our Products in applications requiring extremely high reliability, such as aerospace equipment, nuclear power control systems, and submarine repeaters.
- 9) ROHM shall have no responsibility for any damages or injury arising from non-compliance with the recommended usage conditions and specifications contained herein.
- 10) ROHM has used reasonable care to ensure the accuracy of the information contained in this document. However, ROHM does not warrants that such information is error-free, and ROHM shall have no responsibility for any damages arising from any inaccuracy or misprint of such information.
- 11) Please use the Products in accordance with any applicable environmental laws and regulations, such as the RoHS Directive. For more details, including RoHS compatibility, please contact a ROHM sales office. ROHM shall have no responsibility for any damages or losses resulting non-compliance with any applicable laws or regulations.
- 12) When providing our Products and technologies contained in this document to other countries, you must abide by the procedures and provisions stipulated in all applicable export laws and regulations, including without limitation the US Export Administration Regulations and the Foreign Exchange and Foreign Trade Act.
- 13) This document, in part or in whole, may not be reprinted or reproduced without prior consent of ROHM.



Thank you for your accessing to ROHM product informations.  
More detail product informations and catalogs are available, please contact us.

## ROHM Customer Support System

<https://www.rohm.com/contact/>