

By Category PDF

Category Resistors

Passive Devices

Resistors **R**

Resistors Quick Reference of Package Size ————— 220

Class-leading Compact Size Chip Resistors (RASMID™ series)

Ultra-Compact Chip Resistors (SMR003 <009005>) 222

Thick Film Chip Resistors (Standard series)

General Purpose Chip Resistors :
New MCR series <0402 to 1206> 223

General Purpose Chip Resistors (MCR series <01005 to 1206>) 224

Chip Resistor Networks (MNR series <0402×2 to 0603×4>) 225

8-element Chip Resistor Networks (MNR series <0603×5 to 0602×8>) 226

Thick Film Chip Resistors (High Reliability series)

High Anti-surge Chip Resistors (SDR series) 227

Anti-surge Chip Resistors (ESR series) ... 227

High Power Chip Resistors <Wide Terminal type> <Anti-surge> (LTR series) 228

High Voltage Resistance Chip Resistors (KTR series) 229

Tolerance for Sulfurization Chip Resistor (SFR series) 230

Chip Resistors for Current Detection (Thick Film type)

General Purpose Chip Resistors :
New MCR series <Low ohmic> <0805 to 1206> 231

General Purpose Chip Resistors <Low ohmic> (Low Ohmic MCR series) ... 232

Thick Film Shunt Resistors <Face Down type> (UCR series) 233

High Power Thick Film Shunt Resistors <Wide Terminal type> <Low TCR> (LHR series) 234

High Power Thick Film Shunt Resistors <Wide Terminal type> (Low Ohmic LTR series) 234

Chip Resistors for Current Detection (Metal Plate type)

Metal Plate Shunt Resistors <Ultra Low ohmic> (PMR series) 235

Metal Plate Shunt Resistors <Wide Terminal type> <Ultra Low ohmic> (PML series) 236

High Power Metal Plate Shunt Resistors <Ultra Low ohmic> (PSR series) 237

High Power Metal Plate Shunt Resistors (GMR series) 238

Standard Nominal Resistance Values ————— 239

Resistors

Resistors Quick Reference of Package Size (Shunt Resistors) P.220	Resistors Quick Reference of Package Size (Thick Film Chip Resistors) P.221
Class-leading Compact Size Chip Resistors (RASMID™ series) P.222	Thick Film Chip Resistors (Standard series) P.223
Thick Film Chip Resistors (High Reliability series) P.227	Chip Resistors for Current Detection (Thick Film type) P.231
Chip Resistors for Current Detection (Metal Plate type) P.235	Standard Nominal Resistance Values P.239

Resistors Quick Reference of Package Size

Shunt Resistors

Thick Film Shunt Resistors lineup

Size mm (inch)	Part No.	Terminal type Wide Terminal	Attached type Reverse Attached	Specification General-purpose Ultra-low resistance High Power	Resistance Range (mΩ)	Rated Power (W)	Printing Page
0603 (0201)	UCR006		✓		100 to 910	0.1	P.233
1005 (0402)	UCR01		✓		68 to 910	0.125	P.233
1608 (0603)	UCR03		✓		20 to 200	0.25	P.233
					220 to 910	0.2	
2012 (0805)	New MCR10L			✓	47 to 910	0.5	P.231
	UCR10		✓		11 to 100	0.33	P.233
	☆MCR18L			✓	47 to 910	0.75	P.231
3216 (1206)	UCR18		✓		11 to 39	1	P.233
					43 to 100	0.5	

☆: Under Development

Thick Film Shunt Resistors (Wide Terminal type) lineup

Size mm (inch)	Part No.	Terminal type Wide Terminal	Attached type Reverse Attached	Specification General-purpose Ultra-low resistance High Power	Resistance Range (mΩ)	Rated Power (W)	Printing Page
1220 (0508)	LTR10	✓	✓		47 to 9100	0.5	P.234
	☆LTR10L	✓			33 to 910	1	P.234
1632 (0612)	LTR18	✓			10 to 1000	1.0/☆1.5	P.234
	LHR18	✓			33 to 1000	1.5	P.234
2550 (1020)	LTR50	✓			10 to 910	2	P.234
3264 (1225)	New LTR100L	✓			10 to 91	4	P.234
	LTR100	✓			10 to 910	2	P.234

☆: Under Development

Metal Plate Shunt Resistors lineup

Size mm (inch)	Part No.	Terminal type Wide Terminal	Attached type Reverse Attached	Specification General-purpose Ultra-low resistance High Power	Resistance Range (mΩ)	Rated Power (W)	Printing Page
1005 (0402)	PMR01			✓	10	0.2	P.235
1608 (0603)	PMR03			✓	10	0.25	P.235
					2	1	
2012 (0805)	New PMR10			✓	3 to 10	0.5	P.235
					1, 2	1.5	
3216 (1206)	New PMR18			✓	3 to 10	1	P.235
3225 (1210)	New PMR25			✓	1	2	P.235
					2 to 5	1	
5025 (2010)	New PMR50			✓	1, 2	2	P.235
					3 to 10	1	
					1, 2	3	
6432 (2512)	New PMR100			✓	3 to 10	2	P.235

Metal Plate Shunt Resistors (Wide Terminal type) lineup

Size mm (inch)	Part No.	Terminal type Wide Terminal	Attached type Reverse Attached	Specification General-purpose Ultra-low resistance High Power	Resistance Range (mΩ)	Rated Power (W)	Printing Page
1220 (0508)	PML10	✓		✓	1 to 2.5	0.66	P.236
1632 (0612)	PML18	✓		✓	0.5 to 2.5	1	P.236
2550 (1020)	PML50	✓		✓	0.5, 2.2	2	P.236
3264 (1225)	PML100	✓		✓	0.5 to 2.2	2/3 (at25°C)	P.236

High Power Metal Plate Shunt Resistors lineup

Size mm (inch)	Part No.	Terminal type Wide Terminal	Attached type Reverse Attached	Specification General-purpose Ultra-low resistance High Power	Resistance Range (mΩ)	Rated Power (W) (Rated Terminal Temperature)	Printing Page
5025 (2010)	New GMR50			✓	5 to 220	4 (90°C), 3 (110°C)	P.238
					0.3, 0.5, 1.0	8 (75°C), 4 (140°C)	
6432 (2512)	PSR100			✓	2.0	6 (75°C), 4 (140°C)	P.237
					New 3.0	4 (75°C), 4 (140°C)	
	New GMR100			✓	5 to 220	7 (70°C), 5 (110°C)	P.238
7142 (2817)	New GMR320			✓	5 to 100	10 (70°C), 7 (110°C)	P.238
					0.2	12 (75°C), 5 (130°C)	
10×5.2 (3921)	PSR400			✓	New 0.3, 0.5	10 (75°C), 5 (130°C)	P.237
					1.0	8 (75°C), 5 (130°C)	
					New 2.0	6 (75°C), 4 (115°C)	
					3.0	5 (70°C), 3 (115°C)	
15×7.75 (5931)	PSR500			✓	New 0.1, 0.2	15 (75°C), 10 (120°C)	P.237
					New 0.3, 0.4, 0.5	10 (75°C), 7 (120°C)	
					1.0	10 (75°C), 6 (115°C)	
					2.0	7 (70°C), 4 (115°C)	

Shunt Resistors Table

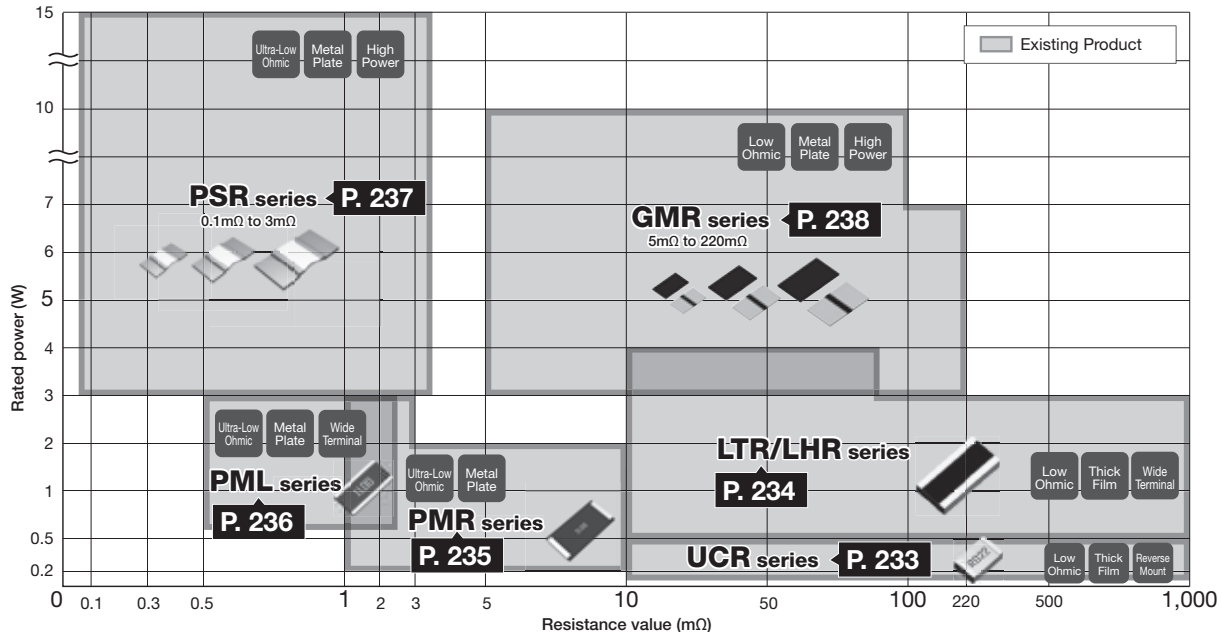

Resistors Quick Reference of Package Size

Thick Film Chip Resistors (Standard series/High Reliability series)

Thick Film Chip Resistors (Standard series/High Reliability series) lineup

Size mm (inch)	Part No.	Package RASMID™	Terminal type Wide Terminal	Specification						Resistance Range (Ω)	Rated Power (W)	Printing Page
				General- purpose	Tolerance for Sulfurization	Anti-surge	High Anti-surge	High Power	High Voltage Resistance			
03015 (009005)	SMR003	✓								10 to 1M	0.02	P.222
0402 (1005)	MCR004			✓						1 to 3M	0.031	P.224
0603 (0201)	MCR006			✓						1 to 10M	0.05	P.224, P.232
1005 (0402)	MCR01S							✓		1 to 10M	0.1	P.223
	MCR01			✓						1 to 10M	0.063	P.224, P.232
	ESR01					✓				1 to 10M	0.2	P.227
	SFR01				✓					1 to 10M	0.063	P.230
1608 (0603)	MCR03S							✓		1 to 10M	0.125	P.223
	MCR03			✓						1 to 10M	0.1	P.224, P.232
	SDR03						✓			1 to 10M	0.3	P.227
	ESR03					✓				1 to 10M	0.25	P.227
	KTR03								✓	1 to 10M	0.1	P.229
	SFR03					✓				1 to 10M	0.1	P.230
2012 (0805)	MCR10S							✓		1 to 10M	0.25	P.223
	MCR10			✓						1 to 10M	0.1/0.125/0.25	P.224, P.232
	SDR10						✓			1 to 10M	0.5	P.227
	ESR10					✓				1 to 10M	0.4	P.227
	KTR10								✓	1 to 10M	0.125	P.229
	SFR10				✓					1 to 10M	0.125	P.230
1220 (0508)	LTR10		✓						✓	1 to 1M	0.25	P.228
			✓						✓	*	☆1	P.228
3216 (1206)	MCR18S								✓	1 to 10M	0.4	P.223
	MCR18			✓						1 to 10M	0.125/0.25	P.224, P.232
	ESR18					✓				1 to 10M	0.5	P.227
	KTR18								✓	1 to 10M	0.25	P.229
	SFR18				✓					1 to 10M	0.25	P.230
1632 (0612)	LTR18		✓						✓	1k to 1M	0.75	P.228
			✓							1 to 976	1.5	P.228
3225 (1210)	ESR25					✓				1 to 10M	0.66	P.227
	KTR25								✓	1 to 10M	0.33	P.229
	SFR25				✓					1 to 1M	0.5	P.230
2550 (1020)	LTR50		✓						✓	1 to 1M	1	P.228
			✓						✓	*	☆2	P.228
3264 (1225)	LTR100		✓						✓	1 to 1M	2	P.228
			✓						✓	*	☆3	P.228

©RASMID™: ROHM's proprietary new method that enables superior dimensional precision, making it possible to develop the ultra-compact products. ☆: Under Development *: Under Evaluation
RASMID™ is a trademark or a registered trademark of ROHM Co., Ltd.

Class-leading Compact Size Chip Resistors (RASMID™ series) Ultra-Compact Chip Resistors (SMR003 <009005>)

- Original process technology ensures greater accuracy
- Chip dimensional precision improved from ±20µm to ±10µm
- Gold electrodes utilized for superior solderability and reliability



*Minimum order quantity is further discussion is needed

SMR003 <009005>								
Part No.	Size Code mm (inch)	Rated Power (70°C)	Limiting Element Voltage (V)	Tolerance	Temperature Coefficient (ppm/°C)	Resistance Range	Operating Temperature (°C)	Automotive Grade AEC-Q200
SMR003	03015 (009005)	0.02W	10	J (±5%)	±200	10 to 1MΩ (E24 series)	-55 to +125	-
				F (±1%)		10 to 1MΩ (E24, E96 series)		

*E24: Standard products E96: Custom products

Jumper type					
Part No.	Size Code mm (inch)	Rated Current (A)	Resistance	Operating Temperature (°C)	Automotive Grade AEC-Q200
SMR003	03015 (009005)	0.5	50mΩ Max	-55 to +125	-

Dimensions (Unit: mm)

Part No.	Size Code mm (inch)	L	W	t	a	b
SMR003	03015 (009005)	0.30±0.01	0.15±0.01	0.11±0.01	-	0.07±0.01

SMR003

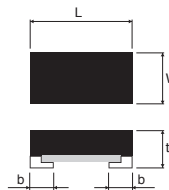

Part No. Explanation

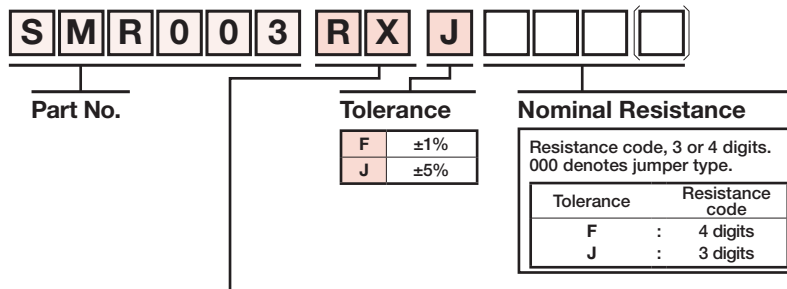

Packaging Specifications Code

Part No.	Code	Tolerance		Packaging Specifications	Reel	Basic Ordering Unit (pcs)
		J (±5%)	F (±1%)			
SMR003	RX	⊙	⊙	Embossed tape (1mm Pitch)	φ180mm (7inch)	40,000*

Reel (φ180mm): Compatible with JEITA standard "EIAJ ET-7200B"
⊙: Standard product

"RASMID™" is a trademark or a registered trademark of ROHM Co., Ltd.
RASMID™: ROHM's proprietary new method that enables superior dimensional precision, making it possible to develop the ultra-compact products.
*Minimum order quantity is further discussion is needed

Thick Film Chip Resistors (Standard series) General Purpose Chip Resistors : New MCR series<0402 to 1206>

- Guaranteed the same rated power as one size larger product by changing the design of the resistive element.
- Circuit space can be saved (reducing the area by about 60% by replacing 0603 size with 0402 size)

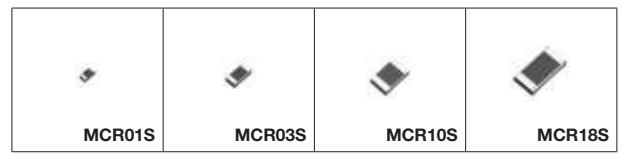

New MCR series <0402 to 1206>								
Part No.	Size Code mm (inch)	Rated Power (70°C)	Limiting Element Voltage (V)	Tolerance	Temperature Coefficient (ppm/°C)	Resistance Range	Operating Temperature (°C)	Automotive Grade AEC-Q200
MCR01S	1005 (0402)	0.1W	75	J (±5%)	±400	1Ω to 9.1Ω (E24 series)	-55 to +155	YES
				F (±1%)	±200	10Ω to 10MΩ (E24 series)		
MCR03S	1608 (0603)	0.125W	150	J (±5%)	±400	1Ω to 9.1Ω (E24 series)		YES
				F (±1%)	±200	10Ω to 10MΩ (E24 series)		
MCR10S	2012 (0805)	0.25W	200	J (±5%)	±400	1Ω to 9.1Ω (E24 series)		YES
				F (±1%)	±200	10Ω to 10MΩ (E24 series)		
MCR18S	3216 (1206)	0.4W	200	J (±5%)	±400	1Ω to 9.1Ω (E24 series)		YES
				F (±1%)	±200	10Ω to 10MΩ (E24 series)		
				F (±1%)	±100	10Ω to 2.2MΩ (E24,96 series)		

*E24: Standard products E96: Custom products

Jumper type					
Part No.	Size Code mm (inch)	Rated Current (A)	Resistance	Operating Temperature (°C)	Automotive Grade AEC-Q200
MCR01S	1005 (0402)	1.5	50mΩ Max	-55 to +155	YES
MCR03S	1608 (0603)	2			YES
MCR10S	2012 (0805)	2.5			YES
MCR18S	3216 (1206)	2.5			YES

Dimensions (Unit: mm)

Part No.	Size Code mm (inch)	L	W	t	a	b
MCR01S	1005 (0402)	1.0±0.05	0.5±0.05	0.35±0.05	0.2±0.1	0.25 ^{+0.05} _{-0.10}
MCR03S	1608 (0603)	1.6±0.1	0.8±0.1	0.45±0.1	0.3±0.2	0.3±0.2
MCR10S	2012 (0805)	2.0±0.1	1.25±0.1	0.55±0.1	0.4±0.2	0.4±0.2
MCR18S	3216 (1206)	3.2 ^{+0.15} _{-0.20}	1.6±0.15	0.55±0.1	0.5±0.25	0.5±0.25

MCR01S/03S (No marking)

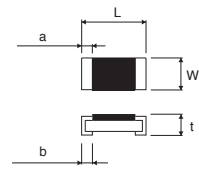

MCR10S/18S (No marking)

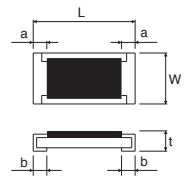

Part No. Explanation

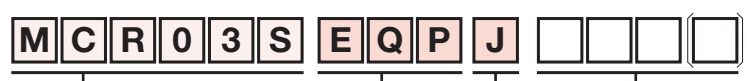

Part No.

Tolerance

F	±1%
J	±5%
J is also used for jumper	

Nominal Resistance

Resistance code, 3 or 4 digits. 000 denotes jumper type.

Tolerance	Resistance code
F	: 4 digits
J	: 3 digits

Packaging Specifications Code

Part No.	Code	Tolerance		Packaging Specifications	Reel	Basic Ordering Unit (pcs)
		J(±5%)	F(±1%)			
MCR01S	MQP	○	○	Paper tape (2mm Pitch)	φ180mm (7inch)	10,000
MCR03S	EQP	○	○	Paper tape (4mm Pitch)	φ180mm (7inch)	5,000
MCR10S	EQP	○	○	Paper tape (4mm Pitch)	φ180mm (7inch)	5,000
MCR18S	EQP	○	○	Paper tape (4mm Pitch)	φ180mm (7inch)	5,000

Reel (φ180mm): Compatible with JEITA standard "EIAJ ET-7200B"
○: Standard product

Thick Film Chip Resistors (Standard series)

General Purpose Chip Resistors (MCR series <01005 to 1206>)

- High reliability chip resistors optimized for a variety of applications.
- Six package sizes, ranging from 01005 to 1205.
- Market-proven reliability.



MCR series <01005 to 1206>									
Part No.	Size Code mm (inch)	Rated Power (70°C)	Limiting Element Voltage (V)	Tolerance	Temperature Coefficient (ppm/°C)	Resistance Range		Operating Temperature (°C)	Automotive Grade AEC-Q200
MCR004	0402 (01005)	0.031W (1/32W)	15	J (±5%)	+600/-100 ±300 ±250	1Ω to 9.1Ω (E24 series) 10Ω to 91Ω (E24 series) 100Ω to 3MΩ (E24 series)	-55 to +125	-	
				F (±1%)	±300 ±250	10Ω to 97.6Ω (E24, E96 series) 100Ω to 3MΩ (E24, E96 series)			
MCR006	0603 (0201)	0.05W	25	J (±5%)	+600/-200 ±200	1Ω to 9.1Ω (E24 series) 10Ω to 10MΩ (E24 series)	-55 to +125	YES	
				F (±1%)	±200	10Ω to 10MΩ (E24, E96 series)			
				D (±0.5%)	±200 ±100	10Ω to 97.6Ω (E24, E96 series) 1kΩ to 1MΩ (E24, E96 series)			
MCR01	1005 (0402)	0.063W (1/16W)	50	J (±5%)	+500/-250 ±200	1Ω to 9.1Ω (E24 series) 10Ω to 10MΩ (E24 series)	-55 to +155	YES	
				F (±1%)	±100	10Ω to 2.2MΩ (E24, E96 series)			
				D (±0.5%)	±100 ±50	10Ω to 97.6Ω (E24, E96 series) 100Ω to 1MΩ (E24, E96 series)			
MCR03	1608 (0603)	0.1W	50	J (±5%)	±400 ±200	1Ω to 9.1Ω (E24 series) 10Ω to 10MΩ (E24 series)	-55 to +155	YES	
				FX (±1%)	±100	10Ω to 10MΩ (E24, E96 series)			
				D (±0.5%)	±100 ±50	10Ω to 97.6Ω (E24, E96 series) 100Ω to 1MΩ (E24, E96 series)			
MCR10	2012 (0805)	0.125W	150	J (±5%)	±400 ±200	1Ω to 9.1Ω (E24 series) 10Ω to 10MΩ (E24 series)	-55 to +155	YES	
				F (±1%)	±100	10Ω to 2.2MΩ (E24, E96 series)			
		0.1W		D (±0.5%)	±100 ±50	10Ω to 97.6Ω (E24, E96 series) 100Ω to 1MΩ (E24, E96 series)			
MCR18	3216 (1206)	0.25W	200	J (±5%)	±400 ±200	1Ω to 9.1Ω (E24 series) 10Ω to 10MΩ (E24 series)	-55 to +155	YES	
				F (±1%)	±100	10Ω to 2.2MΩ (E24, E96 series)			
		0.125W		D (±0.5%)	±100 ±50	10Ω to 97.6Ω (E24, E96 series) 100Ω to 1MΩ (E24, E96 series)			

*E24: Standard products E96: Custom products

Jumper type					
Part No.	Size Code mm (inch)	Rated Current (A)	Resistance	Operating Temperature (°C)	Automotive Grade AEC-Q200
MCR004	0402 (01005)	0.5	50mΩ Max	-55 to +125	-
MCR006	0603 (0201)	0.5			YES
MCR01	1005 (0402)	1			YES
MCR03	1608 (0603)	1		-55 to +155	YES
MCR10	2012 (0805)	2			YES
MCR18	3216 (1206)	2			YES

Dimensions (Unit: mm)

Part No.	Size Code mm (inch)	L	W	t	a	b
MCR004	0402 (01005)	0.4±0.02	0.2±0.02	0.13±0.02	0.1±0.03	0.1 ±0.03
MCR006	0603 (0201)	0.6±0.03	0.3±0.03	0.23±0.03	0.1±0.05	0.15±0.05
MCR01	1005 (0402)	1.0±0.05	0.5±0.05	0.35±0.05	0.2±0.1	0.25 ^{+0.05} _{-0.10}
MCR03	1608 (0603)	1.6±0.1	0.8±0.1	0.45±0.1	0.3±0.2	0.3 ±0.2
MCR10	2012 (0805)	2.0±0.1	1.25±0.1	0.55±0.1	0.4±0.2	0.4 ±0.2
MCR18	3216 (1206)	3.2±0.15	1.6±0.15	0.55±0.1	0.5±0.25	0.5 ±0.25

- MCR004/006/01 (No marking)
- MCR10/18
- MCR03 (Partially marked)

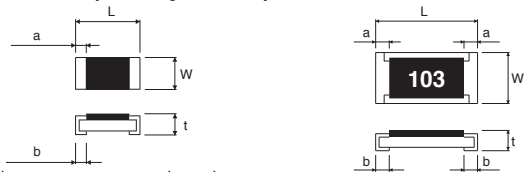

Part No. Explanation



Part No.

Tolerance

Nominal Resistance

D	±0.5%
F (X)	±1%
J	±5%
J is also used for jumper	

Resistance code, 3 or 4 digits. 000 denotes jumper type.	
Tolerance	Resistance code
D, F (X)	: 4 digits
J	: 3 digits

Packaging Specifications Code

Part No.	Code	Tolerance			Packaging Specifications	Reel	Basic Ordering Unit (pcs)
		J (±5%)	F (±1%)	D (±0.5%)			
MCR004	QLP	○	○	—	Paper tape (2mm Pitch)	φ180mm (7inch)	20,000
MCR006	YLP	○	○	○	Paper tape (2mm Pitch)	φ180mm (7inch)	15,000
MCR01	MZP	○	○	○	Paper tape (2mm Pitch)	φ180mm (7inch)	10,000
MCR03	EZP	○	○ (FX)	○	Paper tape (4mm Pitch)	φ180mm (7inch)	5,000
MCR10	EZP	○	○	○	Paper tape (4mm Pitch)	φ180mm (7inch)	5,000
MCR18	EZP	○	○	○	Paper tape (4mm Pitch)	φ180mm (7inch)	5,000

Reel (φ180mm): Compatible with JEITA standard "EIAJ ET-7200B"
○: Standard product

Thick Film Chip Resistors (Standard series) Chip resistor networks (MNR series <0402x2 to 0603x4>)

- Reduces cost
Use of chip networks reduces the number of components and saves mounting space.
- Easy fillet inspection
Convex type electrodes facilitate visual inspection of fillets. Inspection can be performed with automatic inspection equipment.

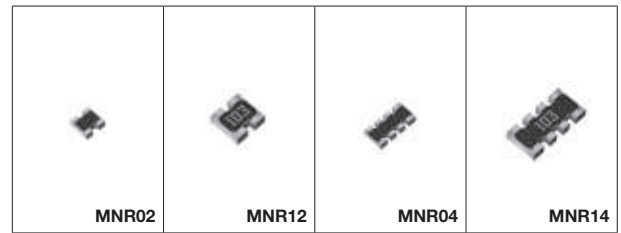

MNR series <0402x2 to 0603x4>										
Part No.	Size Code mm (inch)	No. of Terminals	No. of Elements	Rated Power (70°C)	Limiting Element Voltage (V)	Tolerance	Temperature Coefficient (ppm/°C)	Resistance Range	Operating Temperature (°C)	Automotive Grade AEC-Q200
MNR02	1005 (0402)x2	4	2	0.063W/Element	25	J (±5%)	±200	10Ω to 1MΩ (E24 series)	-55 to +155	YES
MNR04	1005 (0402)x4	8	4	0.063W/Element	25	J (±5%)	+500/-250 ±200	1Ω to 9.1Ω (E24 series) 10Ω to 1MΩ (E24 series)		YES
MNR12	1608 (0603)x2	4	2	0.063W/Element	50	J (±5%)	±200	10Ω to 1MΩ (E24 series)		YES
MNR14	1608 (0603)x4	8	4	0.063W/Element	50	J (±5%)	±500 ±200	2.2Ω to 6.8Ω (E6 series) 10Ω to 1MΩ (E24 series)		YES

Jumper type					
Part No.	Size Code mm (inch)	Rated Current	Resistance	Operating Temperature (°C)	Automotive Grade AEC-Q200
MNR02	1005 (0402)x2	1A/Element	50mΩ Max	-55 to +155	YES
MNR04	1005 (0402)x4	1A/Element			YES
MNR12	1608 (0603)x2	1A/Element			YES
MNR14	1608 (0603)x4	1A/Element			YES

Dimensions (Unit: mm)

- MNR02/MNR12 (Marked except MNR02)
Different marking system may apply to each product type.

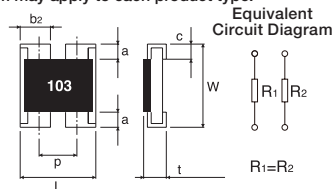

Part No.	L	W	t	a	b ₂	c	p
MNR02	1.0±0.1	1.0±0.1	0.35±0.1	0.2±0.1	0.33 ^{+0.1} _{-0.05}	0.25±0.1	0.68
MNR12	1.6±0.1	1.6±0.1	0.5±0.1	0.3±0.2	0.6±0.15	0.25±0.15	0.8

- MNR04/MNR14 (Marked except MNR04)
Different marking system may apply to each product type.

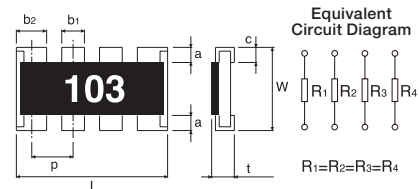

Part No.	L	W	t	a	b ₁	b ₂	c	p
MNR04	2.0±0.1	1.0±0.1	0.35±0.1	0.2±0.1	0.3±0.1	0.4±0.1	0.25±0.1	0.5
MNR14	3.2±0.1	1.6±0.1	0.5±0.1	0.3±0.2	0.4±0.15	0.6±0.15	0.25±0.15	0.8

Part No. Explanation

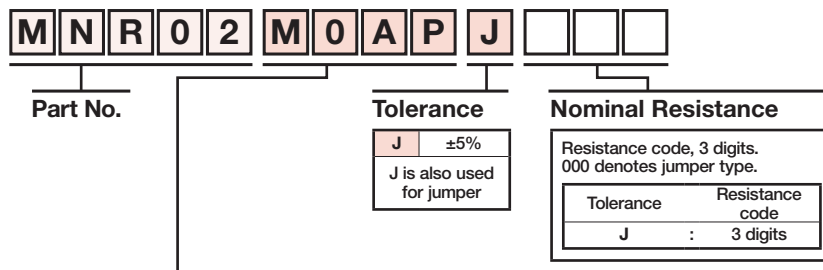

Packaging Specifications Code

Part No.	Code	Tolerance		Packaging Specifications	Reel	Basic Ordering Unit (pcs)
		J (±5%)	F (±1%)			
MNR02	M0AP	⊙	—	Paper tape (2mm Pitch)	φ180mm (7inch)	10,000
MNR04	M0AP	⊙	—	Paper tape (2mm Pitch)	φ180mm (7inch)	10,000
MNR12	E0AP	⊙	—	Paper tape (4mm Pitch)	φ180mm (7inch)	5,000
MNR14	E0AP	⊙	—	Paper tape (4mm Pitch)	φ180mm (7inch)	5,000

Reel (φ180mm): Compatible with JEITA standard "EIAJ ET-7200B"
⊙: Standard product

Thick Film Chip Resistors (Standard series)

8-element Chip Resistor Networks (MNR series <0603x5 to 0602x8>)

- One package built in 8-element chip contributes to space-saving
- 8 resistor elements reduce mounting cost
- Convex type electrodes facilitate visual inspection of fillets. Inspection can be performed with automatic inspection equipment.
- Suitable for pull-up resistor, damping resistor
- No direction to be mounted

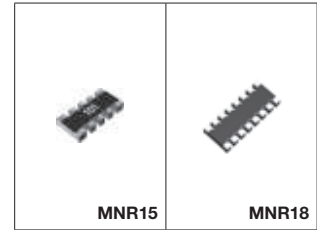

MNR series <0603x5 to 0602x8>										
Part No.	Size Code mm (inch)	No. of Terminals	No. of Elements	Rated Power (70°C)	Limiting Element Voltage (V)	Tolerance	Temperature Coefficient (ppm/°C)	Resistance Range	Operating Temperature (°C)	Automotive Grade AEC-Q200
MNR15	1608 (0603)×5	10	8	0.031W/Element	12.5	J (±5%)	±200	56Ω to 100kΩ (E24 series)	-55 to +125	YES
MNR18	1605 (0602)×8	16	8	0.063W/Element*	25	J (±5%)	±200	10Ω to 1MΩ (E24 series)		YES

*Power for a packing Max 0.25W in all elements

Jumper type					
Part No.	Size Code mm (inch)	Rated Current	Resistance	Operating Temperature (°C)	Automotive Grade AEC-Q200
MNR18	1605 (0602)×8	1A/Element*	50mΩ Max	-55 to +125	YES

*Power for a packing Max 4A in all elements

Dimensions (Unit: mm)

● MNR15

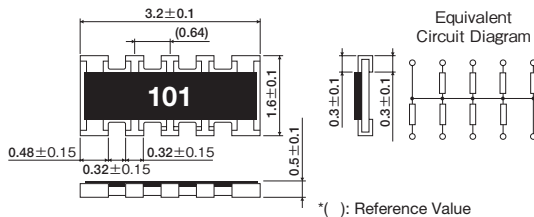

(): Reference Value

● MNR18 (No marking)

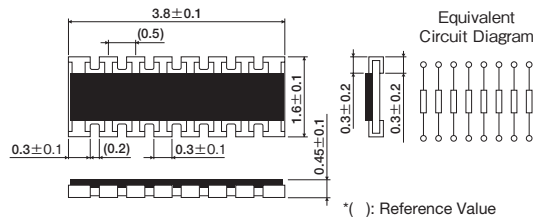

(): Reference Value

Part No. Explanation

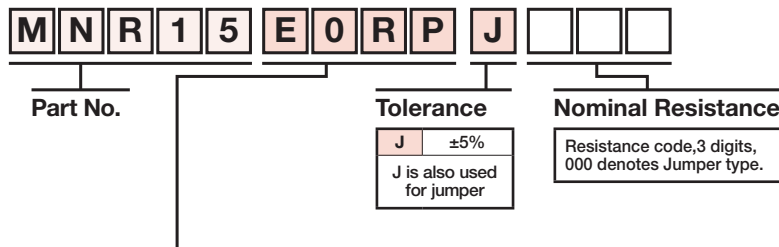

Packaging Specifications Code

Part No.	Code	Tolerance	Packaging Specifications	Reel	Basic Ordering Unit (pcs)
		J (±5%)			
MNR15	E0RP	○	Paper tape (4mm Pitch)	φ180mm (7inch)	5,000
MNR18	E0AP	○	Paper tape (4mm Pitch)	φ180mm (7inch)	5,000

Reel (φ180mm): Compatible with JEITA standard "EIAJ ET-7200B"
 ○: Standard product

Thick Film Chip Resistors (High Reliability series) High Anti-surge Chip Resistors (SDR series) Anti-surge Chip Resistors (ESR series)

- Exclusive resistive element pattern and laser trimming technology results in significantly improved surge resistance characteristics.
- Superior power ratings.



SDR series								
Part No.	Size Code mm (inch)	Rated Power (70°C)	Limiting Element Voltage (V)	Tolerance	Temperature Coefficient (ppm/°C)	Resistance Range	Operating Temperature (°C)	Automotive Grade AEC-Q200
SDR03	1608 (0603)	0.3W	150	J (±5%)	±200	1Ω to 10MΩ (E24 series)	-55 to +155	YES
				F (±1%)	±200	1Ω to 9.76Ω (E24, E96 series)		
				D (±0.5%)	±100	10Ω to 10MΩ (E24, E96 series)		
SDR10	2012 (0805)	0.5W	400	J (±5%)	±200	1Ω to 10MΩ (E24 series)		
				F (±1%)	±100	1Ω to 10MΩ (E24, E96 series)		
				D (±0.5%)	±100	10Ω to 1MΩ (E24, E96 series)		

ESR series								
Part No.	Size Code mm (inch)	Rated Power (70°C)	Limiting Element Voltage (V)	Tolerance	Temperature Coefficient (ppm/°C)	Resistance Range	Operating Temperature (°C)	Automotive Grade AEC-Q200
ESR01	1005 (0402)	0.2W	50	J (±5%)	+500/-250	1Ω to 9.1Ω (E24 series)	-55 to +155	YES
				F (±1%)	±200	10Ω to 10MΩ (E24 series)		
ESR03	1608 (0603)	0.25W	150	J (±5%)	±100	10Ω to 976kΩ (E24, E96 series)		
				F (±1%)	±200	1MΩ to 2.2MΩ (E24 series)		
				D (±0.5%)	±100	10Ω to 10MΩ (E24 series)		
ESR10	2012 (0805)	0.4W	150	J (±5%)	±200	1Ω to 10MΩ (E24 series)		
				F (±1%)	±100	1Ω to 10MΩ (E24, E96 series)		
				D (±0.5%)	±100	10Ω to 1MΩ (E24, E96 series)		
ESR18	3216 (1206)	0.5W	200	J (±5%)	±200	1Ω to 10MΩ (E24 series)		
				F (±1%)	±100	1Ω to 10MΩ (E24, E96 series)		
				D (±0.5%)	±100	10Ω to 1MΩ (E24, E96 series)		
ESR25	3225 (1210)	0.66W (2/3W)	200	J (±5%)	±200	1Ω to 10MΩ (E24 series)		
				F (±1%)	±100	1Ω to 10MΩ (E24, E96 series)		
				D (±0.5%)	±100	10Ω to 1MΩ (E24, E96 series)		

*E24: Standard products E96: Custom products

Dimensions (Unit: mm)

Part No.	Size Code mm (inch)	L	W	t	a	b
SDR03	1608 (0603)	1.6±0.1	0.8±0.1	0.45±0.1	0.25±0.1	0.25±0.1
SDR10	2012 (0805)	2.0±0.1	1.25±0.1	0.55±0.1	0.25±0.1	0.4±0.2
ESR01	1005 (0402)	1.0±0.05	0.5±0.05	0.35±0.05	0.2±0.1	0.25 ^{+0.05} _{-0.1}
ESR03	1608 (0603)	1.6±0.1	0.8±0.1	0.45±0.1	0.3±0.2	0.3±0.2
ESR10	2012 (0805)	2.0±0.1	1.25±0.1	0.55±0.1	0.3±0.2	0.4±0.2
ESR18	3216 (1206)	3.2±0.15	1.6±0.15	0.55±0.1	0.3±0.25	0.5±0.25
ESR25	3225 (1210)	3.2±0.15	2.5±0.15	0.55±0.1	0.3±0.25	0.5±0.25

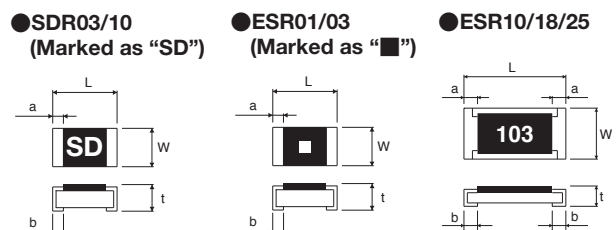

Part No. Explanation

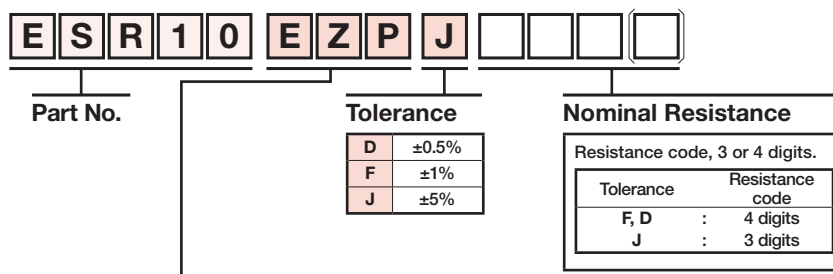

Packaging Specifications Code

Part No.	Code	Tolerance			Packaging Specifications	Reel	Basic Ordering Unit (pcs)
		J (±5%)	F (±1%)	D (±0.5%)			
SDR03	EZP	○	○	○	Paper tape (4mm Pitch)	φ180mm (7inch)	5,000
SDR10	EZP	○	○	○	Paper tape (4mm Pitch)	φ180mm (7inch)	5,000
ESR01	MZP	○	○	—	Paper tape (2mm Pitch)	φ180mm (7inch)	10,000
ESR03	EZP	○	○	○	Paper tape (4mm Pitch)	φ180mm (7inch)	5,000
ESR10	EZP	○	○	○	Paper tape (4mm Pitch)	φ180mm (7inch)	5,000
ESR18	EZP	○	○	○	Paper tape (4mm Pitch)	φ180mm (7inch)	5,000
ESR25	JZP	○	○	○	Embossed tape (4mm Pitch)	φ180mm (7inch)	4,000

Reel (φ180mm): Compatible with JEITA standard "EIAJ ET-7200B"
○: Standard product

Thick Film Chip Resistors (High Reliability series) High Power Chip Resistors <Wide Terminal type><Anti-surge> (LTR series)

- High joint reliability with long side terminations.
- Highest power ratings in their class.
- Guaranteed anti-surge characteristic in all series.

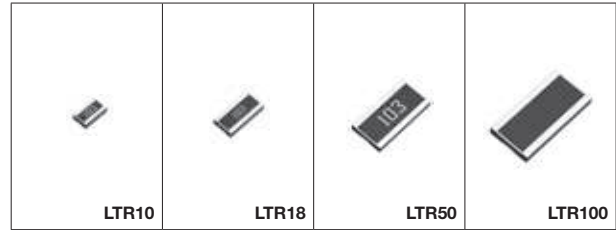

LTR series								
Part No.	Size Code mm (inch)	Rated Power (70°C)	Limiting Element Voltage (V)	Tolerance	Temperature Coefficient (ppm/°C)	Resistance Range	Operating Temperature (°C)	Automotive Grade AEC-Q200
LTR10	1220 (0508)	0.25W	150	J (±5%)	±200	1Ω to 1MΩ (E24 series)	-55 to +155	YES
		☆1W*		F (±1%)	±100	1Ω to 1MΩ (E24, E96 series)		
				D (±0.5%)	±100	10Ω to 1MΩ (E24, E96 series)		
LTR18	1632 (0612)	New 1.5W (95°C)*	200	J (±5%)	±200	1Ω to 976Ω (E24 series)		
				F (±1%)	±100	1Ω to 976Ω (E24, E96 series)		
				D (±0.5%)	±100	10Ω to 976Ω (E24, E96 series)		
		0.75W		J (±5%)	±200	1kΩ to 1MΩ (E24 series)		
				F (±1%)	±100	1kΩ to 1MΩ (E24, E96 series)		
				D (±0.5%)	±100	1kΩ to 1MΩ (E24, E96 series)		
LTR50	2550 (1020)	1W	200	J (±5%)	±200	1Ω to 1MΩ (E24 series)		
		☆2W*		F (±1%)	±100	1Ω to 1MΩ (E24, E96 series)		
				D (±0.5%)	±100	10Ω to 1MΩ (E24, E96 series)		
LTR100	3264 (1225)	2W	200	J (±5%)	±200	1Ω to 1MΩ (E24 series)		
		☆3W*		F (±1%)	±100	1Ω to 1MΩ (E24, E96 series)		
				D (±0.5%)	±100	10Ω to 1MΩ (E24, E96 series)		

☆: Under Development
*Guaranteed by terminal temperature derating (LTR18: 1Ω to 976Ω)
(LTR18) Less than 1kΩ: Terminal temperature (95°C) guarantee, 1kΩ or more: Ambient temperature (70°C) guarantee.

Dimensions (Unit: mm)

Part No.	Size Code mm (inch)	L	W	t	a	b
LTR10	1220 (0508)	1.2±0.1	2.0±0.1	0.55±0.1	0.25±0.1	0.35±0.2
LTR18	1632 (0612)	1.6±0.15	3.2±0.15	0.55±0.1	0.3±0.2	0.5±0.2
LTR50	2550 (1020)	2.5±0.15	5.0±0.15	0.55±0.1	0.38±0.2	0.9±0.2
LTR100	3264 (1225)	3.2±0.15	6.4±0.15	0.55±0.15	0.4±0.25	1.13±0.25

LTR10/18/50

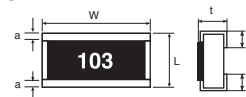

LTR100 (No marking)

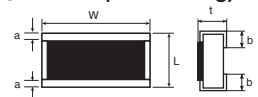

Part No. Explanation

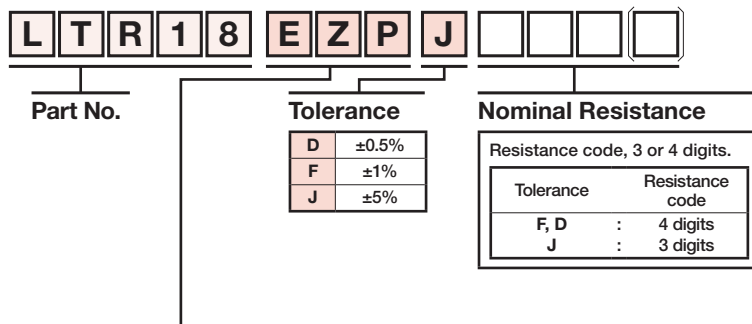

Packaging Specifications Code

Part No.	Code	Tolerance			Packaging Specifications	Reel	Basic Ordering Unit (pcs)
		J (±5%)	F (±1%)	D (±0.5%)			
LTR10	EZP	○	○	○	Paper tape (4mm Pitch)	φ180mm (7inch)	5,000
LTR18	EZP	○	○	○	Paper tape (4mm Pitch)	φ180mm (7inch)	5,000
LTR50	UZP	○	○	○	Embossed tape (4mm Pitch)	φ180mm (7inch)	5,000
LTR100	JZP	○	○	○	Embossed tape (4mm Pitch)	φ180mm (7inch)	4,000

Reel (φ180mm): Compatible with JEITA standard "EIAJ ET-7200B"
○: Standard product

Thick Film Chip Resistors (High Reliability series) High Voltage Resistance Chip Resistors (KTR series)

- Twice the rated voltage of conventional products.
- Perfect for use in Camera Flash circuit, etc.

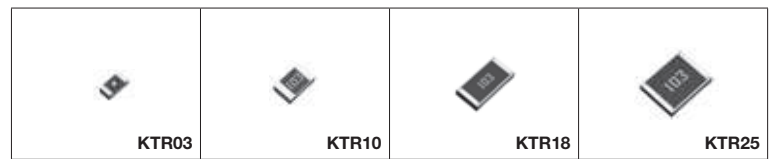

KTR series									
Part No.	Size Code mm (inch)	Rated Power (70°C)	Limiting Element Voltage (V)	Tolerance	Temperature Coefficient (ppm/°C)	Resistance Range	Operating Temperature (°C)	Automotive Grade AEC-Q200	
KTR03	1608 (0603)	0.1W	350	J (±5%)	±200	1Ω to 1MΩ (E24 series)	-55 to +155	YES	
				F (±1%)	±200	1Ω to 9.76Ω (E24, E96 series)			
KTR10	2012 (0805)	0.125W	400		J (±5%)	±200			1Ω to 30MΩ (E24 series)
				F (±1%)	±100	1Ω to 10MΩ (E24, E96 series)			
KTR18	3216 (1206)	0.25W	500	J (±5%)	±200	1Ω to 10MΩ (E24 series)		YES	
				F (±1%)	±100	1Ω to 10MΩ (E24, E96 series)			
KTR25	3225 (1210)	0.33W (1/3W)	600	J (±5%)	±200	1Ω to 10MΩ (E24 series)		YES	
				F (±1%)	±100	1Ω to 10MΩ (E24, E96 series)			

*E24: Standard products E96: Custom products

Dimensions (Unit: mm)

Part No.	Size Code mm (inch)	L	W	t	a	b
KTR03	1608 (0603)	1.6±0.1	0.8±0.1	0.45±0.1	0.3±0.2	0.3±0.2
KTR10	2012 (0805)	2.0±0.1	1.25±0.1	0.55±0.1	0.3±0.2	0.4±0.2
KTR18	3216 (1206)	3.2±0.15	1.6±0.15	0.55±0.1	0.3±0.25	0.5±0.25
KTR25	3225 (1210)	3.2±0.15	2.5±0.15	0.55±0.1	0.3±0.25	0.5±0.25

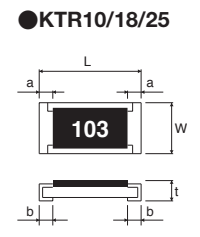
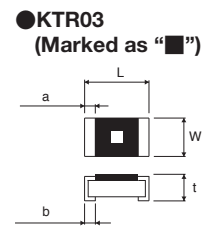

Part No. Explanation

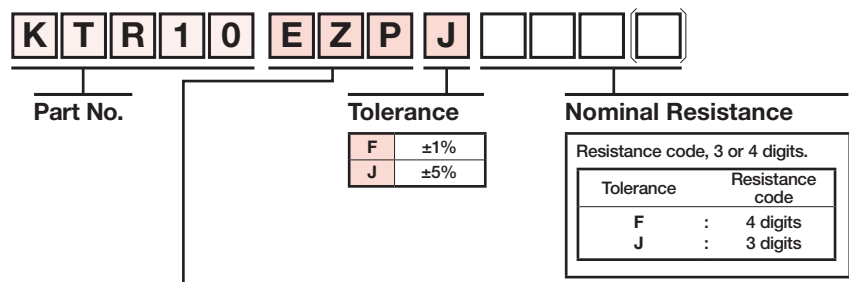

Packaging Specifications Code

Part No.	Code	Tolerance		Packaging Specifications	Reel	Basic Ordering Unit (pcs)
		J (±5%)	F (±1%)			
KTR03	EZP	○	○	Paper tape (4mm Pitch)	φ180mm (7inch)	5,000
KTR10	EZP	○	○	Paper tape (4mm Pitch)	φ180mm (7inch)	5,000
KTR18	EZP	○	○	Paper tape (4mm Pitch)	φ180mm (7inch)	5,000
KTR25	JZP	○	○	Embossed tape (4mm Pitch)	φ180mm (7inch)	4,000

Reel (φ180mm): Compatible with JEITA standard "EIAJ ET-7200B"
 ○: Standard product

Thick Film Chip Resistors (High Reliability series) Tolerance for Sulfurization Chip Resistor (SFR series)

• Improved Anti-sulfur reliability by ROHM original structure.

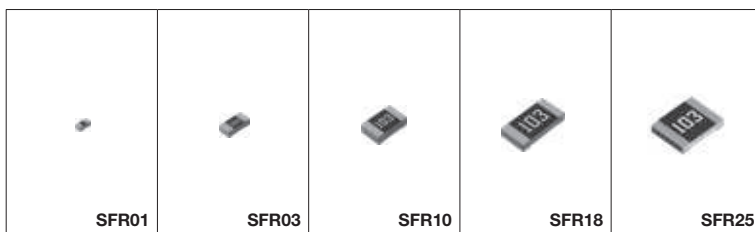

SFR series								
Part No.	Size Code mm (inch)	Rated Power (70°C)	Limiting Element Voltage (V)	Tolerance	Temperature Coefficient (ppm/°C)	Resistance Range	Operating Temperature (°C)	Automotive Grade AEC-Q200
SFR01	1005 (0402)	0.063W (1/16W)	50	J (±5%)	+500/-250 ±200	1Ω to 9.1Ω (E24 series) 10Ω to 10MΩ (E24 series)	-55 to +155	YES
				F (±1%)	±100	10Ω to 2.2MΩ (E24, E96 series)		
SFR03	1608 (0603)	0.1W	50	J (±5%)	±400 ±200	1Ω to 9.1Ω (E24 series) 10Ω to 10MΩ (E24 series)		YES
				F (±1%)	±100	10Ω to 10MΩ (E24, E96 series)		
SFR10	2012 (0805)	0.125W	150	J (±5%)	±400 ±200	1Ω to 9.1Ω (E24 series) 10Ω to 10MΩ (E24 series)		YES
				F (±1%)	±100	10Ω to 2.2MΩ (E24, E96 series)		
SFR18	3216 (1206)	0.25W	200	J (±5%)	±400 ±200	1Ω to 9.1Ω (E24 series) 10Ω to 10MΩ (E24 series)		YES
				F (±1%)	±100	10Ω to 2.2MΩ (E24, E96 series)		
SFR25	3225 (1210)	0.5W	200	J (±5%)	±200	1Ω to 1MΩ (E24 series)		YES
				F (±1%)	±100	10Ω to 1MΩ (E24, E96 series)		

*E24: Standard products E96: Custom products

Jumper type					
Part No.	Size Code mm (inch)	Rated Current (A)	Resistance	Operating Temperature (°C)	Automotive Grade AEC-Q200
SFR01	1005 (0402)	1	50mΩ Max	-55 to +155°C	YES
SFR03	1608 (0603)	1			YES
SFR10	2012 (0805)	2			YES
SFR18	3216 (1206)	2			YES
SFR25	3225 (1210)	2			YES

Dimensions (Unit: mm)

Part No.	Size Code mm (inch)	L	W	t	a	b
SFR01	1005 (0402)	1.0±0.05	0.5±0.05	0.35±0.05	0.33±0.08	0.25 ^{+0.05} _{-0.10}
SFR03	1608 (0603)	1.6±0.1	0.8±0.1	0.45±0.1	0.4±0.2	0.3±0.2
SFR10	2012 (0805)	2.0±0.1	1.25±0.1	0.55±0.1	0.4±0.2	0.4±0.2
SFR18	3216 (1206)	3.2 ^{+0.15} _{-0.20}	1.6±0.15	0.55±0.1	0.55±0.25	0.5±0.25
SFR25	3225 (1210)	3.2 ^{+0.15} _{-0.20}	2.5±0.15	0.55±0.1	0.55±0.25	0.5±0.25

●SFR01 (No marking)

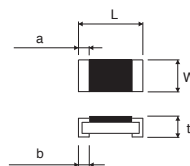

●SFR03/10/18/25

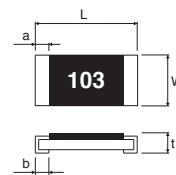

Part No. Explanation

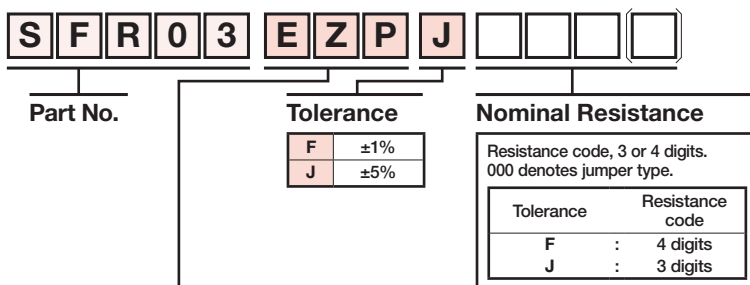

Packaging Specifications Code

Part No.	Code	Tolerance		Packaging Specifications	Reel	Basic Ordering Unit (pcs)
		J (±5%)	F (±1%)			
SFR01	MZP	○	○	Paper tape (2mm Pitch)	φ180mm (7inch)	10,000
SFR03	EZP	○	○	Paper tape (4mm Pitch)	φ180mm (7inch)	5,000
SFR10	EZP	○	○	Paper tape (4mm Pitch)	φ180mm (7inch)	5,000
SFR18	EZP	○	○	Paper tape (4mm Pitch)	φ180mm (7inch)	5,000
SFR25	JZP	○	○	Embossed tape (4mm Pitch)	φ180mm (8inch)	4,000

Reel (φ180mm): Compatible with JEITA standard "EIAJ ET-7200B"
○: Standard product

Chip Resistors for Current Detection (Thick Film type)

General Purpose Chip Resistors : New MCR series <Low ohmic><0805 to 1206>

- Guaranteed the same rated power as one size larger product by changing the design of the resistive element.
- Very-low ohmic resistance from 47m Ohm is in lineup by thick-film resistive element.
- High-reliability chip resistor employing metal glaze as resistive element.

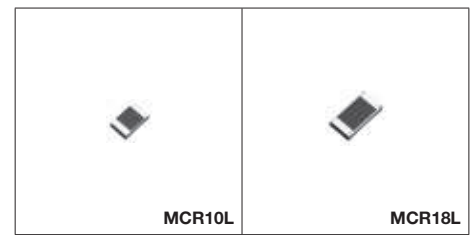

New MCR series <Low ohmic>							
Part No.	Size Code mm (inch)	Rated Power (70°C)	Tolerance	Temperature Coefficient (ppm/°C)	Resistance Range	Operating Temperature (°C)	Automotive Grade AEC-Q200
New MCR10L	2012 (0805)	0.5W	J (±5%)	0 to 250	47mΩ to 110mΩ (E24 series)	-55 to 155	YES
				0 to 150	120mΩ to 910mΩ (E24 series)		
			F (±1%)	0 to 250	47mΩ to 110mΩ (E24 series)		
				0 to 150	120mΩ to 910mΩ (E24 series)		
☆MCR18L	3216 (1206)	0.75W	J (±5%)	0 to 250	47mΩ to 91mΩ (E24 series)	-55 to 155	YES
				0 to 150	100mΩ to 910mΩ (E24 series)		
			F (±1%)	0 to 250	47mΩ to 91mΩ (E24 series)		
				0 to 150	100mΩ to 910mΩ (E24 series)		

☆: Under Development

Dimensions (Unit: mm)

Part No.	Size Code mm (inch)	L	W	t	a	b
MCR10L	2012 (0805)	2.0±0.1	1.25±0.1	0.58±0.1	0.60 to 0.45 ±0.20	0.4 ±0.2
MCR18L	3216 (1206)	3.2±0.15	1.6±0.15	0.55±0.1	0.90 to 0.75 ±0.25	0.5 ±0.25

●MCR10L/18L (No marking)

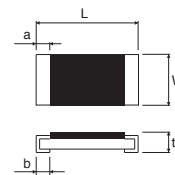

Part No. Explanation

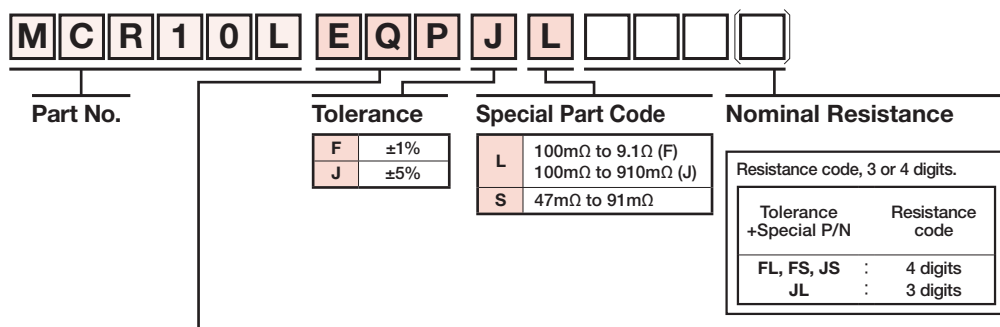

Packaging Specifications Code

Part No.	Code	Tolerance		Packaging Specifications	Reel	Basic Ordering Unit (pcs)
		J(±5%)	F(±1%)			
MCR10L	EQP	○	○	Paper tape (4mm Pitch)	φ180mm (7inch)	5,000
MCR18L	EQP	○	○	Paper tape (4mm Pitch)	φ180mm (7inch)	5,000

Reel (φ180mm): Compatible with JEITA standard "EIAJ ET-7200B"
 ○: Standard product

Chip Resistors for Current Detection (Thick Film type) General Purpose Chip Resistors <Low ohmic> (Low Ohmic MCR series)

- Very-low ohmic resistance from 47m Ohm is in lineup by thick-film resistive element.
- High-reliability chip resistor employing metal glaze as resistive element.

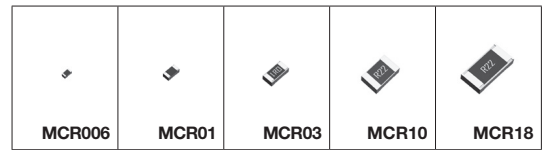

Low Ohmic MCR series							
Part No.	Size Code mm (inch)	Rated Power (70°C)	Tolerance	Temperature Coefficient (ppm/°C)	Resistance Range	Operating Temperature (°C)	Automotive Grade AEC-Q200
MCR006	0603 (0201)	0.05W	F (±1%)	+600/-200	1Ω to 9.1Ω (E24 series)	-55 to +155	YES
MCR01	1005 (0402)	0.063W (1/16W)	F (±1%)	±400	1Ω to 9.1Ω (E24 series)		YES
MCR03	1608 (0603)	0.1W	F (±1%)	±400	1Ω to 9.1Ω (E24 series)		YES
MCR10	2012 (0805)	0.25W	J (±5%) F (±1%)	*Table 1 *Table 1	47mΩ to 910mΩ (E24 series) 47mΩ to 9.1Ω (E24 series)		YES
MCR18	3216 (1206)	0.25W	J (±5%) F (±1%)	*Table 1 *Table 1	47mΩ to 910mΩ (E24 series) 47mΩ to 9.1Ω (E24 series)		

*Table 1

Tolerance	Temperature Coefficient (ppm/°C)	Resistance Range
J (±5%) F (±1%)	500±300	47mΩ to 91mΩ (E24 series)
	400±200	100mΩ to 130mΩ (E24 series)
	±250	150mΩ to 9.1Ω (E24 series)

Dimensions (Unit: mm)

Part No.	Size Code mm (inch)	L	W	t	a	b
MCR006	0603 (0201)	0.6±0.03	0.3±0.03	0.23±0.03	0.1±0.05	0.15±0.05
MCR01	1005 (0402)	1.0±0.05	0.5±0.05	0.35±0.05	0.2±0.1	0.25 ^{+0.05} _{-0.1}
MCR03	1608 (0603)	1.6±0.1	0.8±0.1	0.45±0.1	0.3±0.2	0.3±0.2
MCR10	2012 (0805)	2.0±0.1	1.25±0.1	0.55±0.1	0.4±0.2	0.4±0.2
MCR18	3216 (1206)	3.2±0.15	1.6±0.15	0.55±0.1	0.5±0.25	0.5±0.25

●MCR006/01 (No marking)

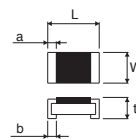

●MCR03

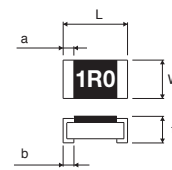

●MCR10/18

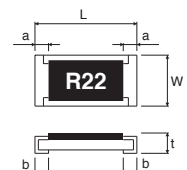

Part No. Explanation

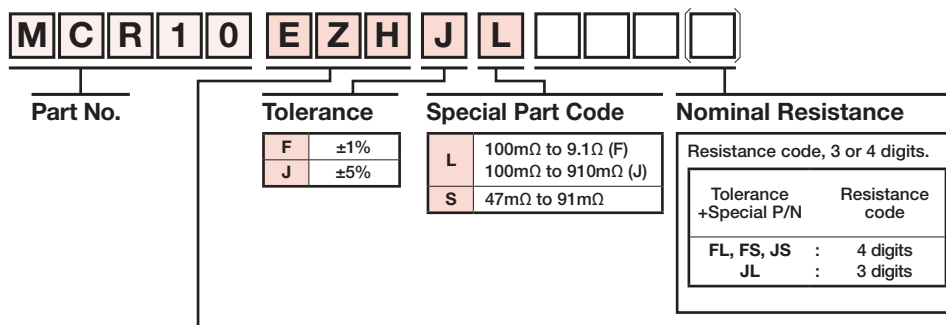

Packaging Specifications Code

Part No.	Code	Tolerance		Packaging Specifications	Reel	Basic Ordering Unit (pcs)
		J (±5%)	F (±1%)			
MCR006	YLP	—	○	Paper tape (2mm Pitch)	φ180mm (7inch)	15,000
MCR01	MZP	—	○	Paper tape (2mm Pitch)	φ180mm (7inch)	10,000
MCR03	EZP	—	○	Paper tape (4mm Pitch)	φ180mm (7inch)	5,000
MCR10	EZH	○	○	Paper tape (4mm Pitch)	φ180mm (7inch)	5,000
MCR18	EZH	○	○	Paper tape (4mm Pitch)	φ180mm (7inch)	5,000

Reel (φ180mm): Compatible with JEITA standard "EIAJ ET-7200B"
○: Standard product

Chip Resistors for Current Detection (Thick Film type) Thick Film Shunt Resistors <Face Down type> (UCR series)

- Chip resistors for current detection. (11mΩ or more)
- Resistive element is located at bottom side, which reduces the resistance shift during mounting process.
- ROHM's unique structure achieved improvement of heat.

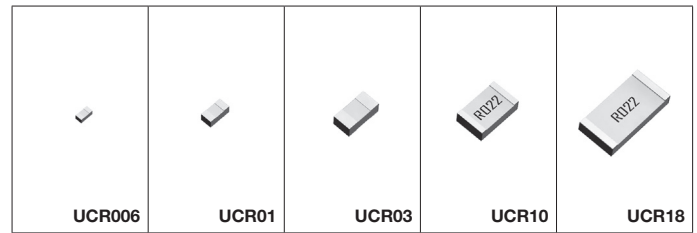

UCR series									
Part No.	Size Code mm (inch)	Rated Power (70°C)	Tolerance	Temperature Coefficient (ppm/°C)	Resistance Range	Operating Temperature (°C)	Automotive Grade AEC-Q200		
UCR006	0603 (0201)	0.1W	J (±5%)	0 to 300	100mΩ to 910mΩ (E24 series)	-55 to +155	YES		
			F (±1%)						
UCR01	1005 (0402)	0.125W	J (±5%)	0 to 300	68mΩ to 91mΩ (E24 series)		-55 to +155	YES	
			F (±1%)	0 to 250	100mΩ to 200mΩ (E24 series)				
UCR03	1608 (0603)	0.25W	J (±5%)	0 to 250	20mΩ to 47mΩ (E24 series)			-55 to +155	YES*
			F (±1%)	0 to 200	51mΩ to 91mΩ (E24 series)				
		0.2W	J (±5%)	0 to 150	100mΩ to 200mΩ (E24 series)				
			F (±1%)	0 to 150	220mΩ to 910mΩ (E24 series)				
UCR10	2012 (0805)	0.33W (1/3W)	J (±5%)	250±200	11mΩ to 18mΩ (E24 series)	-55 to +155			YES
			F (±1%)	0 to 250	20mΩ to 47mΩ (E24 series)				
UCR18	3216 (1206)	1W	J (±5%)	0 to 350	11mΩ to 18mΩ (E24 series)		-55 to +155		YES
			F (±1%)	0 to 200	20mΩ to 39mΩ (E24 series)				
		0.5W	J (±5%)	0 to 150	43mΩ to 100mΩ (E24 series)				
			F (±1%)						

*Limited to 100mΩ and higher

Dimensions (Unit: mm)

Part No.	Size Code mm (inch)	L	W	t	a	b
UCR006	0603 (0201)	0.62±0.05	0.32±0.05	0.24±0.05	0.18±0.1	0.22±0.1
UCR01	1005 (0402)	1.0±0.1	0.55±0.1	0.37±0.05	0.28±0.1	0.34±0.1
UCR03	1608 (0603)	1.6±0.1	0.87±0.1	0.5±0.1	0.45±0.2	0.45±0.2
UCR10	2012 (0805)	2.0±0.1	1.25±0.1	0.55±0.1	0.24±0.2	0.5±0.2
UCR18	3216 (1206)	3.2±0.15	1.6±0.15	0.55±0.1	0.3±0.2	0.9±0.25

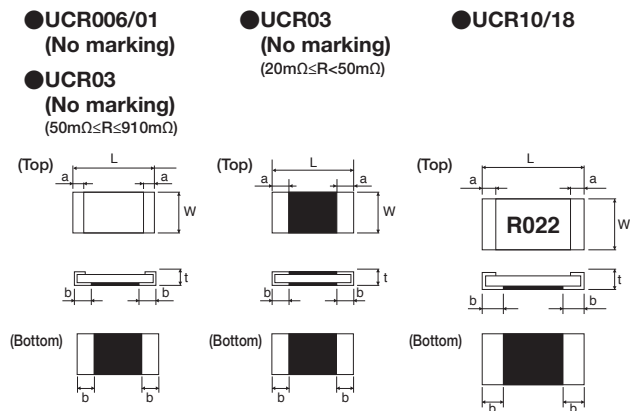

Part No. Explanation

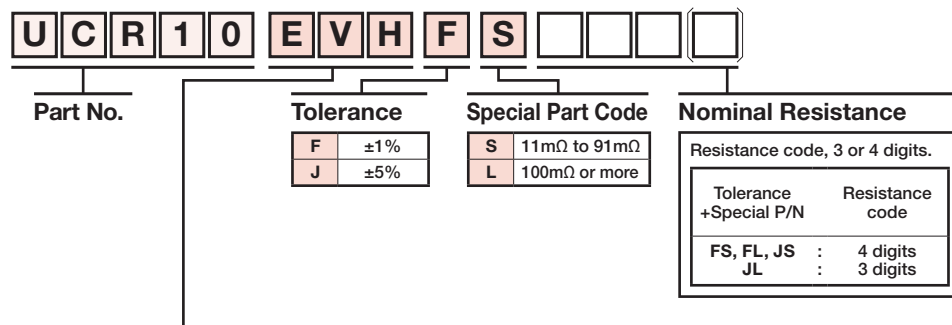

Packaging Specifications Code

Part No.	Code	Tolerance		Packaging Specifications	Reel	Basic Ordering Unit (pcs)	Remarks
		J (±5%)	F (±1%)				
UCR006	YVP	○	○	Paper tape (2mm Pitch)	φ180mm (7inch)	15,000	—
UCR01	MVP	○	○	Paper tape (2mm Pitch)	φ180mm (7inch)	10,000	—
UCR03	EWP	○	○	Paper tape (4mm Pitch)	φ180mm (7inch)	5,000	20mΩ to 47mΩ
	EVP	○	○	Paper tape (4mm Pitch)	φ180mm (7inch)	5,000	51mΩ to 910mΩ
UCR10	EVH	○	○	Paper tape (4mm Pitch)	φ180mm (7inch)	5,000	—
UCR18	EVH	○	○	Paper tape (4mm Pitch)	φ180mm (7inch)	5,000	—

Reel (φ180mm): Compatible with JEITA standard "EIAJ ET-7200B"
○: Standard product

Chip Resistors for Current Detection (Thick Film type)

High Power Thick Film Shunt Resistors <Wide Terminal type> <Low TCR> (LHR series)

High Power Thick Film Shunt Resistors <Wide Terminal type> (Low Ohmic LTR series)

- Chip resistors for current detection. (10mΩ or more)
- High joint reliability with long side terminations.
- Improvement of rated power enables to displace smaller size of resistors, and it contributes space savings in your set.

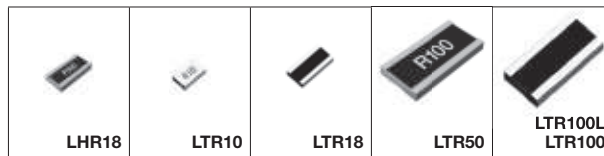

LHR series										
Part No.	Size Code mm (inch)	Rated Power (70°C)	Tolerance	Temperature Coefficient (ppm/°C)	Resistance Range	Operating Temperature (°C)	Automotive Grade AEC-Q200			
LHR18	1632 (0612)	1.25W	J (±5%)	0 to 125	33mΩ to 39mΩ (E24 series)	-55 to +155	YES			
			F (±1%)	0 to 100	43mΩ to 270mΩ (E24 series)					
Low Ohmic LTR series										
LTR10	1220 (0508)	0.5W	J (±5%)	±150	47mΩ to 9.1Ω (E24 series)	-55 to +155	YES			
☆LTR10L			☆1W*					J (±5%)	0 to 150	33mΩ to 91mΩ (E24 series)
								F (±1%)	0 to 100	100mΩ to 910mΩ (E24 series)
LTR18	1632 (0612)	1W	J (±5%)	0 to 300	10mΩ to 18mΩ (E24 series)	-55 to +155	YES			
			F (±1%)	0 to 200	20mΩ to 47mΩ (E24 series)					
LTR50	2550 (1020)	2W	J (±5%)	0 to 200	51mΩ to 470mΩ (E24 series)	-55 to +155	YES			
			F (±1%)	0 to 150	510mΩ to 1Ω (E24 series)					
LTR100	3264 (1225)	2W	J (±5%)	±200	100mΩ to 910mΩ (E24 series)	-55 to +155	YES			
			F (±1%)	0 to 150	100mΩ to 180mΩ (E24 series)					
New LTR100L	3264 (1225)	4W* (110°C)	J (±5%)	0 to 300	10mΩ to 18mΩ (E24 series)	-65 to +155	YES			
			F (±1%)	0 to 200	20mΩ to 47mΩ (E24 series)					

☆: Under Development
*Guaranteed by terminal temperature derating

Dimensions (Unit: mm)

Part No.	Size Code mm (inch)	L	W	t	a	b
LHR18	1632 (0612)	1.6±0.1	3.2±0.1	0.58±0.1	0.3±0.2	0.5±0.2
LTR10	1220 (0508)	1.2±0.1	2.0±0.1	0.55±0.1	0.3±0.2	0.35±0.2
LTR10L		1.25±0.15	2.0±0.15	0.55±0.1	0.28±0.15	0.35±0.2
LTR18	1632 (0612)	1.6±0.1	3.2±0.1	0.58±0.1	0.5±0.2	0.5±0.2
LTR50	2550 (1029)	2.5±0.15	5.0±0.15	0.58±0.1	0.38±0.2	0.9±0.2
LTR100	3264 (1225)	3.2±0.15	6.4±0.15	0.55±0.15	0.4±0.25	1.13±0.25
LTR100L		3.1±0.15	6.4±0.15	0.58±0.15	0.5±0.25	1.0±0.25

● LTR10/LTR10L

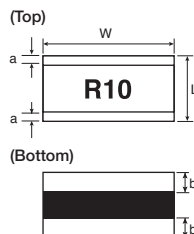

● LHR18/LTR50 (Marking) ● LTR18/LTR100/LTR100L (No marking)

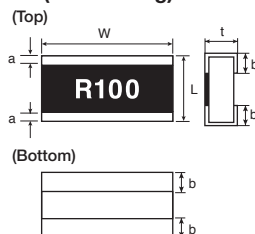

Part No. Explanation

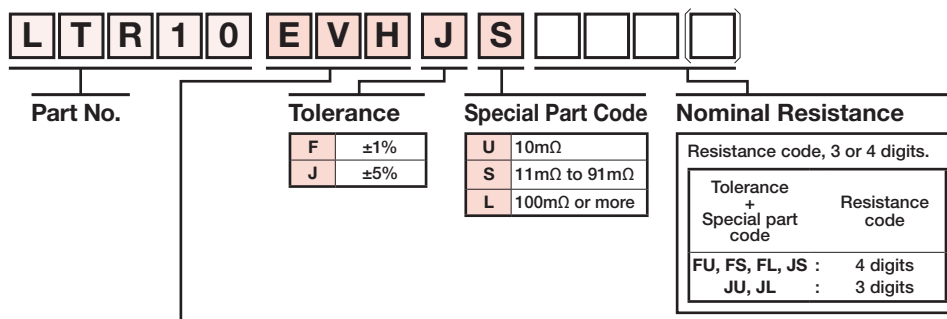

Packaging Specifications Code

Part No.	Code	Tolerance		Packaging Specifications	Reel	Basic Ordering Unit (pcs)
		J (±5%)	F (±1%)			
LHR18	EZP	○	○	Paper tape (4mm Pitch)	φ180mm (7inch)	5,000
LTR10	EVH	○	○	Paper tape (4mm Pitch)	φ180mm (7inch)	5,000
LTR10L*	EZP	○	○	Paper tape (4mm Pitch)	φ180mm (7inch)	5,000
LTR18	EZP	○	○	Paper tape (4mm Pitch)	φ180mm (7inch)	5,000
LTR50	UZP	○	○	Embossed tape (4mm Pitch)	φ180mm (7inch)	5,000
LTR100	JZP	○	○	Embossed tape (4mm Pitch)	φ180mm (7inch)	4,000
LTR100L	JZP	○	○	Embossed tape (4mm Pitch)	φ180mm (7inch)	4,000

○: Standard product
*LTR10L D class (±0.5%) is available for 100mΩ to 910mΩ only

Chip Resistors for Current Detection (Metal Plate type) Metal Plate Shunt Resistors <Ultra Low ohmic> (PMR series)

- Ultra low-ohmic resistance range (1mΩ or more)
- Improved current detection accuracy by trimming-less structure.
 - Highly recommended for large current/ High speed switching circuit.
- Special low resistance temperature coefficient (TCR) alloy utilized for the resistive element.

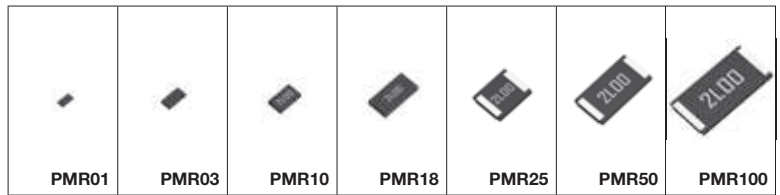

PMR series							
Part No.	Size Code mm (inch)	Rated Power (Rated Ambient Temperature 70°C)	Tolerance	Temperature Coefficient (ppm/°C)	Resistance Value (mΩ)	Operating Temperature (°C)	Automotive Grade AEC-Q200
PMR01	1005 (0402)	0.2W	J (±5%)	0 to 200	10	-55 to +155	YES
PMR03	1608 (0603)	0.25W	J (±5%) F (±1%)	0 to 150	10		YES
PMR10	2012 (0805)	0.5W	J (±5%) F (±1%)	±150	3, 4, 5, 6, 7, 8, 9, 10		YES
PMR18	3216 (1206)	1W	J (±5%) F (±1%)	±100	3, 4, 5, 6, 7, 8, 9, 10		YES
PMR25	3225 (1210)	1W	J (±5%) F (±1%)	±100	2, 3, 4, 5		YES
PMR50	5025 (2010)	1W	J (±5%) F (±1%)	±100	3, 4, 5, 6, 7, 8, 9, 10		YES
PMR100	6432 (2512)	2W	J (±5%) F (±1%)	±150 ±100	3, 4, 5, 6, 7, 8, 9, 10		YES

Rated power up PMR series							
Part No.	Size Code mm (inch)	Rated Power (Rated Terminal Temperature 130°C)	Tolerance	Temperature Coefficient (ppm/°C)	Resistance Value (mΩ)	Operating Temperature (°C)	Automotive Grade AEC-Q200
New PMR10	2012 (0805)	1W*	J (±5%) F (±1%)	±100	2	-65 to +155	YES
New PMR18	3216 (1206)	1.5W*	J (±5%) F (±1%)	±100	1, 2		YES
New PMR25	3225 (1210)	2W*	J (±5%) F (±1%)	±75	1	-65 to +175	YES
New PMR50	5025 (2010)	2W*	J (±5%) F (±1%)	±75	1, 2		YES
New PMR100	6432 (2512)	3W*	J (±5%) F (±1%)	±150 ±75	1, 2		YES

*Guaranteed by terminal temperature derating

Large Current Jumper type					
Part No.	Size Code mm (inch)	Rated Current (A)	Resistance	Operating Temperature (°C)	Automotive Grade AEC-Q200
PMR01	1005 (0402)	20.0	0.5mΩ Max	-55 to +155	YES
PMR03	1608 (0603)	22.4			YES
PMR10	2012 (0805)	31.6			YES
PMR18	3216 (1206)	38.7			YES
PMR25	3225 (1210)	44.7			YES
PMR50	5025 (2010)	50.0			YES
PMR100	6432 (2512)	63.2			YES

Dimensions (Unit: mm)

Part No.	Size Code mm (inch)	L	W	t	a	b	c
PMR01	1005 (0402)	1.0±0.05	0.5±0.05	0.25±0.1	—	0.25±0.10	—
PMR03	1608 (0603)	1.6±0.15	0.8±0.15	0.25±0.1	—	0.35±0.15	—
PMR10	2012 (0805)	2.0±0.15	1.2±0.15	0.42 to 0.28*±0.15	—	0.75 to 0.35*±0.25	—
PMR18	3216 (1206)	3.2±0.15	1.6±0.15	0.44 to 0.28*±0.15	—	1.20 to 0.5 *±0.25	—
PMR25	3225 (1210)	3.2±0.2	2.5±0.2	0.52 to 0.32*±0.15	0.5±0.2	1.00 to 0.8 *±0.2	1.95±0.2
PMR50	5025 (2010)	5.0±0.2	2.5±0.2	0.52 to 0.32*±0.15	0.5±0.2	1.85 to 0.9 *±0.2	1.95±0.2
PMR100	6432 (2512)	6.4±0.25	3.2±0.25	0.52 to 0.32*±0.15	0.5±0.25	2.3 to 1.1 *±0.25	2.65±0.25

*Each value range varies with the resistance. Please contact a ROHM sales representative for further details.

- PMR01/03 (No marking)
- PMR25/50/100
- PMR10/18

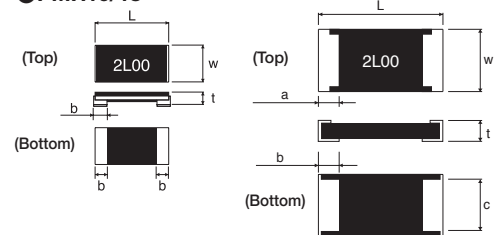

Part No. Explanation



Part No.

Tolerance	
F	±1%
J	±5%

Special Part Code	
U	5mΩ to 10mΩ
V	1mΩ to 4mΩ

*Jumper type doesn't have a special part code

Nominal Resistance

Resistance code, 3 or 4 digits. 000 denotes jumper type.

Tolerance	Resistance code
F	: 4 digits
J	: 3 digits

Packaging Specifications Code

Part No.	Code	Tolerance		Packaging Specifications	Reel	Basic Ordering Unit (pcs)
		J (±5%)	F (±1%)			
PMR01	ZZP	○	—	Embossed tape (2mm Pitch)	φ180mm (7inch)	10,000
PMR03	EZP	○	○	Paper tape (4mm Pitch)	φ180mm (7inch)	5,000
PMR10	EZP	○	○	Paper tape (4mm Pitch)	φ180mm (7inch)	5,000
PMR18	EZP	○	○	Paper tape (4mm Pitch)	φ180mm (7inch)	5,000
PMR25	HZP	○	○	Embossed tape (4mm Pitch)	φ180mm (7inch)	2,000
PMR50	HZP	○	○	Embossed tape (4mm Pitch)	φ180mm (7inch)	2,000
PMR100	HZP	○	○	Embossed tape (4mm Pitch)	φ180mm (7inch)	2,000

Reel (φ180mm): Compatible with JEITA standard "EIAJ ET-7200B"
○: Standard product

Resistance Value (Ω)	Tolerance	
	J	F
Jumper	000	—
1mΩ	1L0	1L00
2mΩ	2L0	2L00
3mΩ	3L0	3L00
4mΩ	4L0	4L00
5mΩ	5L0	5L00
6mΩ	6L0	6L00
7mΩ	7L0	7L00
8mΩ	8L0	8L00
9mΩ	9L0	9L00
10mΩ	10L	10L0

Chip Resistors for Current Detection (Metal Plate type) Metal Plate Shunt Resistors <Wide Terminal type> <Ultra Low ohmic> (PML series)

- Ultra-low resistance range (0.5mΩ or more).
- Wide terminal configuration for high joint reliability.
- Avoiding heat concentration by trimming-less structure and it reduce temperature rise.

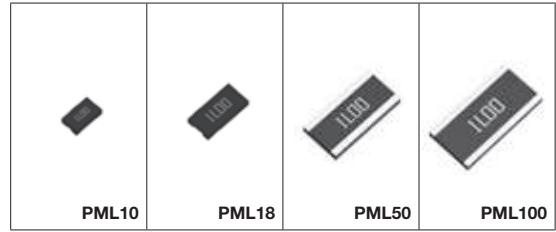

PML series							
Part No.	Size Code mm (inch)	Rated Power (70°C)	Tolerance	Temperature Coefficient (ppm/°C)	Resistance Value (mΩ)	Operating Temperature (°C)	Automotive Grade AEC-Q200
PML10	1220 (0508)	0.66W (2/3W)	J (±5%) G (±2%)	±200	1.0, 1.5, 2.0, 2.5	-55 to +155	YES
PML18	1632 (0612)	1W	J (±5%) G (±2%)	±150	0.5, 1.0, 1.5, 2.0, 2.5		YES
PML50	2550 (1020)	2W	J (±5%)	±150 ±100	0.5 2.2		YES
PML100	3264 (1225)	2W (3W at 25°C) 2W	J (±5%)	±100 ±150	1.0, 1.5, 2.0, 2.2 0.5		YES

Dimensions (Unit: mm)

Part No.	Size Code mm (inch)	L	W	t	a	b
PML10	1220 (0508)	1.2±0.15	2.0±0.15	0.42 to 0.28 ±0.15	—	0.45 to 0.35 ±0.25
PML18	1632 (0612)	1.6±0.15	3.2±0.15	0.42 to 0.28* ±0.15	—	0.55 to 0.35 ±0.25
PML50	2550 (1020)	2.6±0.20	5.0±0.2	0.5 to 0.36* ±0.15	0.4±0.2	0.75 to 0.7* ±0.2
PML100	3264 (1225)	3.2±0.25	6.4±0.25	0.5 to 0.36* ±0.15	0.45±0.25	0.9 to 0.7* ±0.25

*Each value range varies with the resistance. Please contact a ROHM sales representative for further details.

● PML10/18

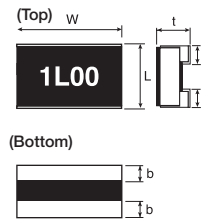

● PML50/100

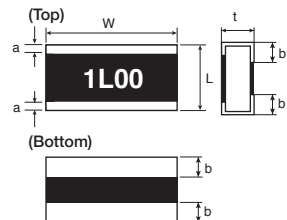

Part No. Explanation



Part No.

Tolerance

Special Part Code

Nominal Resistance

G	±2%
J	±5%

Resistance code, 3 or 4 digits.	
Tolerance	Resistance code
J	: 3 digits
G	: 4 digits

Resistance Value (Ω)	Tolerance	
	J	G
0.5mΩ	0L5	0L50
1mΩ	1L0	1L00
1.5mΩ	1L5	1L50
2mΩ	2L0	2L00
2.2mΩ	2L2	—
2.5mΩ	2L5	2L50

Packaging Specifications Code

Part No.	Code	Tolerance		Packaging Specifications	Reel	Basic Ordering Unit (pcs)
		J (±5%)	G (±2%)			
PML10	EZP	○	○	Paper tape (4mm Pitch)	φ180mm (7inch)	5,000
PML18	EZP	○	○	Paper tape (4mm Pitch)	φ180mm (7inch)	5,000
PML50	HZP	○	—	Embossed tape (4mm Pitch)	φ180mm (7inch)	2,000
PML100	HZP	○	—	Embossed tape (4mm Pitch)	φ180mm (7inch)	2,000

Reel (φ180mm): Compatible with JEITA standard "EIAJ ET-7200B"
 ○: Standard product

Chip Resistors for Current Detection (Metal Plate type) High Power Metal Plate Shunt Resistors <Ultra Low ohmic> (PSR series)

- High power 3W to 15W
- Ultra low resistance range (0.1mΩ or more).
- Excellent TCR characteristics
- Convex structure



Rated power up PSR series							
Part No.	Size Code mm (inch)	Rated Power (Rated Terminal Temperature)	Tolerance	Temperature* coefficient (ppm/°C)	Resistance Range (mΩ)	Operating Temperature (°C)	Automotive Grade AEC-Q200
PSR100	6432 (2512)	8W (75°C), 4W (140°C)	F (±1%)	0 to +150	0.3	-65 to +175	YES
				0 to +115	0.5		
		0 to +100		1.0			
		0 to +50		2.0			
PSR400	10×5.2 (3921)	12W (75°C), 5W (130°C)	F (±1%)	125±50	0.2		
		10W (75°C), 5W (130°C)		0 to +100	New 0.3		
		10W (75°C), 5W (130°C)		0 to +100	0.5		
		8W (75°C), 5W (130°C)		0 to +75	1.0		
		6W (75°C), 4W (115°C)		0 to +75	New 2.0		
		5W (70°C), 3W (115°C)		0 to +75	3.0		
PSR500	15×7.75 (5931)	15W (75°C), 10W (120°C)	F (±1%)	200±50	0.1	YES	
		15W (75°C), 10W (120°C)		0 to +100	New 0.2		
		10W (75°C), 7W (120°C)		0 to +100	New 0.3		
		10W (75°C), 7W (120°C)		0 to +100	New 0.4		
		10W (75°C), 7W (120°C)		0 to +100	0.5		
		10W (75°C), 6W (120°C)		0 to +75	1.0		
		7W (70°C), 4W (115°C)		0 to +75	2.0		

*(+20°C to +175°C)

Dimensions (Unit: mm)

Part No.	Resistance	L	W	t	H	b
PSR100	0.3mΩ	6.35±0.15	3.05±0.25	1.45±0.15	0.35±0.15	1.12±0.3
	0.5mΩ			1.15±0.15		
	1.0mΩ			0.75±0.15		
	2.0mΩ			1.00±0.15		
	3.0mΩ			0.75±0.15		
PSR400	0.2mΩ	10±0.3	5.2±0.3	1.9±0.15	0.5±0.15	2.0±0.6
	0.3mΩ			1.85±0.15		
	0.5mΩ			1.3±0.15		
	1.0mΩ			0.9±0.15		
	2.0mΩ			1.1±0.15		
PSR500	0.1mΩ	15±0.3	7.75±0.3	1.96±0.15	0.5±0.15	4.0±0.6
	0.2mΩ			1.85±0.15		
	0.3mΩ			1.4±0.15		
	0.4mΩ			1.15±0.15		
	0.5mΩ			1.05±0.15		
	1.0mΩ			1.35±0.15		
	2.0mΩ			0.9±0.15		

PSR100/400/500

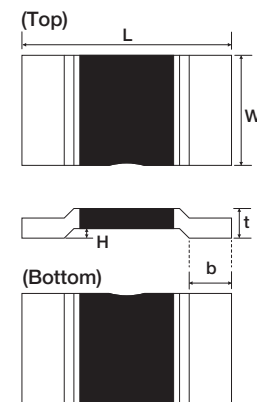

Part No. Explanation



Part No.

Tolerance

Special Part Code

Nominal Resistance

F ±1%

B	0.1mΩ	F	0.5mΩ
C	0.2mΩ	H	1.0mΩ
D	0.3mΩ	J	2.0mΩ
E	0.4mΩ	L	3.0mΩ

Resistance code, 4 digits.	
Tolerance	Resistance code
F	: 4 digits

Packaging Specifications Code

Part No.	Code	Tolerance F (±1%)	Packaging Specifications	Reel	Basic Ordering Unit (pcs)
PSR100	KTQ	○	Embossed tape (8mm Pitch)	φ330mm (13inch)	5,000
PSR400	ITQ	○	Embossed tape (8mm Pitch)	φ330mm (13inch)	3,000
PSR500	HTQ	○	Embossed tape (12mm Pitch)	φ330mm (13inch)	2,000

○: Standard product Reel (φ330mm): Compatible with JEITA standard "EIAJ ET-7200B"

Resistance	F
0.1mΩ	0L10
0.2mΩ	0L20
0.3mΩ	0L30
0.4mΩ	0L40
0.5mΩ	0L50
1.0mΩ	1L00
2.0mΩ	2L00
3.0mΩ	3L00

Chip Resistors for Current Detection (Metal Plate type) High Power Metal Plate Shunt Resistors (GMR series)

- High power (3W to 10W)
- High heat dissipation
- Excellent TCR characteristics
- Low ohmic (5mΩ to 220mΩ)

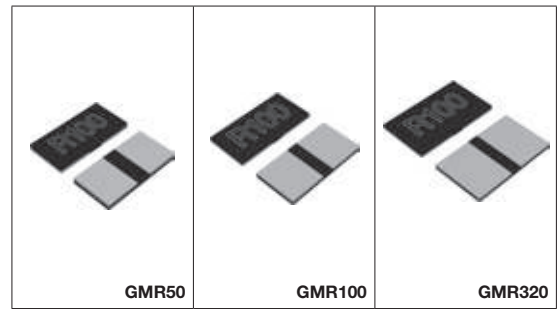

GMR series							
Part No.	Size Code mm (inch)	Rated Power (Rated Terminal Temperature)	Tolerance	Temperature ^{*1} Coefficient (ppm/°C)	Resistance Range	Operating Temperature (°C)	Automotive Grade AEC-Q200
New GMR50	5025 (2010)	4W (90°C), 3W (110°C)	F (±1%)	0 to +25	5mΩ	-65 to +170	YES
				±25	10mΩ to 220mΩ (E24 series) ^{*2}		
New GMR100	6432 (2512)	7W (70°C), 5W (110°C)	F (±1%)	0 to +25	5mΩ		YES
				±20	10mΩ to 220mΩ (E24 series) ^{*2}		
New GMR320	7142 (2817)	10W (70°C), 7W (110°C)	F (±1%)	0 to +25	5mΩ		YES
				±25	10mΩ to 100mΩ (E24 series) ^{*2}		

^{*1} (+20°C to +60°C)
^{*2} Development schedule will vary depending on resistance value. Please contact us for resistance values.

Dimensions (Unit: mm)

Part No.	Size Code mm (inch)	L	W	t	b
GMR50	5025 (2010)	5.00±0.25	2.50±0.25	0.40±0.15	2.05±0.25
GMR100	6432 (2512)	6.40±0.25	3.20±0.25	0.40±0.15	2.75±0.25
GMR320	7142 (2817)	7.10±0.25	4.20±0.25	0.40±0.15	3.10±0.25

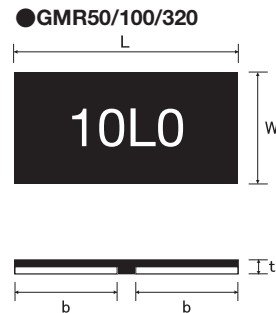

Part No. Explanation

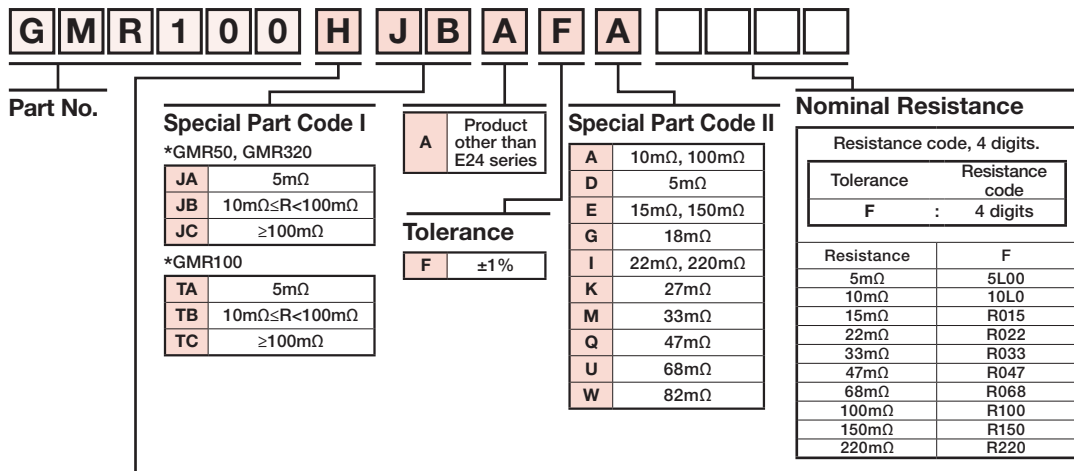

Packaging Specifications Code

Part No.	Code	Tolerance F (±1%)	Packaging Specifications	Reel	Basic Ordering Unit (pcs)
GMR50	H	○	Embossed tape (4mm Pitch)	φ180mm	2,000
GMR100	H	○	Embossed tape (8mm Pitch)	φ180mm	2,000
GMR320	H	○	Embossed tape (8mm Pitch)	φ180mm	2,000

○: Standard product

Standard Nominal Resistance Values

E3	10				22				47			
E6	10		15		22		33		47		68	
E12	10	12	15	18	22	27	33	39	47	56	68	82
E24	10	11	12	13	15	16	18	20	22	24	27	30
	33	36	39	43	47	51	56	62	68	75	82	91
E96	100	102	105	107	110	113	115	118	121	124	127	130
	133	137	140	143	147	150	154	158	162	165	169	174
	178	182	187	191	196	200	205	210	215	221	226	232
	237	243	249	255	261	267	274	280	287	294	301	309
	316	324	332	340	348	357	365	374	383	392	402	412
	422	432	442	453	464	475	487	499	511	523	536	549
	562	576	590	604	619	634	649	665	681	698	715	732
750	768	787	806	825	845	866	887	909	931	953	976	

Nominal Resistance

Resistors of a series fall into one of nominal resistance ranges shown in the table above. Nominal resistance is determined by the common ratio shown right.

Series	Common ratio	Remarks
E6	$\sqrt[6]{10} \approx 1.46$	Rounded off to a 2-digit figure.
E12	$\sqrt[12]{10} \approx 1.21$	
E24	$\sqrt[24]{10} \approx 1.10$	
E96	$\sqrt[96]{10} \approx 1.02$	Rounded off to a 3-digit figure.

Resistance Coding

Nominal resistance is expressed in 3 digits when the resistance tolerance is $\pm 5\%$ and in 4 digits when $\pm 1\%$.

The leading 2 or 3 digits indicate significant figure while the last digit indicates the number of zeros. The letter R or L denotes the decimal point if necessary.

- Ex.1 $22\Omega \rightarrow 22 \times 10^0\Omega \rightarrow 220$ (the last digit indicates the number "0" of a multiplier)
- Ex.2 $47k\Omega \rightarrow 47 \times 10^3\Omega \rightarrow 473$ (the last digit indicates the number "3" of a multiplier)
- Ex.3 $1.2M\Omega \rightarrow 12 \times 10^5\Omega \rightarrow 125$ (the last digit indicates the number "5" of a multiplier)
- Ex.4 $2.7\Omega \rightarrow 2R7$ (the decimal point indicate the letter R/the letter R apply to the low Resistance less than 10Ω)
- Ex.5 $1130\Omega \rightarrow 113 \times 10^1\Omega \rightarrow 1131$ (the last digit indicates the number "1" of a multiplier/Resistance Tolerance 1% (F) products)
- Ex.6 $0.10\Omega \rightarrow R10$
- Ex.7 $1m\Omega \rightarrow 1L0$

Supplement of Rated Power

When the ambient temperature exceeds the rated ambient temperature, derate the load power based on the derating curve.

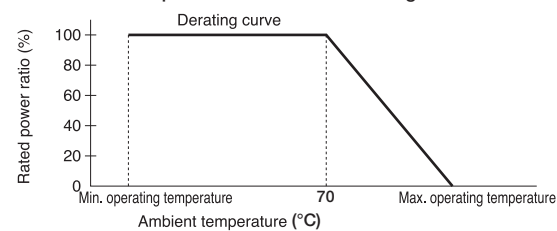

(LTR18, LTR100L, PMR series, PSR series, GMR series)

When the terminal temperature with load exceeds the rated terminal temperature, derate the load power based on the derating curve.

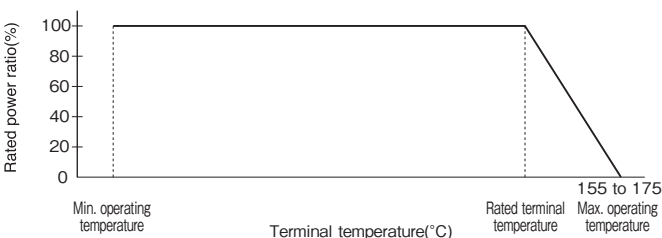

For basic guidelines on using resistors, see the technical reports issued by Japan Electronics and Information Technology Industries Association. JEITA RCR-2121A. "Guideline of notabilia for fixed resistors for use in electronic equipment (Safety Application Guide for fixed resistors for use in electronic equipment)"

	Rated terminal Temperature
LTR18	95°C
LTR100L	95°C
PMR series	130°C
PSR series	115 to 140°C*
GMR series	110°C

*Refer to P.237

Supplementary to Notes

*1 When resistor is to be exposed to a transient load (excessive large load, such as pulse), mount the resistor on your product and check the condition and evaluate the result. Constant application of a voltage above the rated voltage will degrade the performance and reliability of the resistor.

Do not apply a voltage exceeding the rated voltage across any ROHM resistors.

*2 Rated voltage (V) = $\sqrt{\text{rated power (W)} \times \text{nominal resistance } (\Omega)}$ or the limiting element voltage, whichever smaller, is the rated voltage.