

By Category PDF

Category Laser Diodes









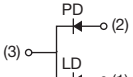

Opto Devices

Laser Diodes

Red Lasers	259
Infrared Lasers	260
High Power Infrared Lasers	261
High Power Infrared VCSEL	261
Part Numbers, Symbols and Definitions	262
Packaging Specifications	264

Laser Diodes			
Red Lasers	P.259	Infrared Lasers	P.260
High Power Infrared Lasers	P.261	High Power Infrared VCSEL	P.261
Part Numbers, Symbols and Definitions	P.262	Packaging Specifications	P.264

Laser Diodes

Red Lasers															
Part No.	Wavelength λ_P (nm)	Absolute Maximum Ratings (T _C =25°C)			Electrical and Optical Characteristics (T _C =25°C)								P _O (mW)	Package	Equivalent Circuit
		P _O (mW)	V _R (V)	Topr Max (°C)	I _{TH} (mA)	I _{OP} (mA)	η (W/A)	V _{OP} (V)	I _m (mA)	$\theta_{L\perp}$ (deg)	$\theta_{//}$ (deg)				
RLD65MZT7	655	7	2	70	20	30	0.70	2.3	0.24	27.0	8.0	5			
RLD63NPC5 (Pure red)	635	6	2	40	24	33	0.55	2.2	0.18	32.0	8.0	5			
RLD63NPC6 (Pure red)	638	12	2	50	28	43	0.70	2.3	0.15	32.0	8.0	10			
RLD63NPC7 (Pure red)	638	17	2	50	32	57	0.60	2.2	0.16	30.0	8.0	15			
RLD63NPC8 (Pure red)	638	24	2	50	32	65	0.60	2.25	0.20	30.0	8.0	20			
RLD65NZX1 (Higher temp.)	663	10	2	80	15	24	0.85	2.3	0.30	27.0	9.0	7			
RLD65NZX2 (Higher ESD)	658	7	2	70	25	33	0.60	2.3	0.20	28.0	8.5	5			
RLD63PZCA (Pure red)	638	7	2	50	28	33	0.80	2.2	0.08	32.0	8.0	5			
RLD65PZX2 (Higher ESD)	658	7	2	70	25	33	0.60	2.3	0.20	28.0	8.5	5			
RLD65PZX3 (Higher ESD)	658	12	2	70	25	42	0.60	2.3	0.30	28.0	8.5	10			

Note: Unless otherwise specified, the Electrical and Optical Characteristics are typical values.

●About open package products

With the open package product (Package mark is P), the external environment could deteriorate the characteristics and reliability of Laser Diodes. Please be careful to foreign matter including toner, human substance and smoke, corrosion due to ion, the volatilization component from the glue and flux, condensation, optical tweezers effect and etc. Do not touch the components including the laser chip emission point.



Laser Diodes

Infrared Lasers															
Part No.	Wavelength λ_p (nm)	Absolute Maximum Ratings (T _c =25°C)			Electrical and Optical Characteristics (T _c =25°C)								P _o (mW)	Package	Equivalent Circuit
		P _o (mW)	V _R (V)	Topr Max (°C)	I _{TH} (mA)	I _{op} (mA)	η (W/A)	V _{op} (V)	I _m (mA)	θ_{\perp} (deg)	$\theta_{//}$ (deg)				
RLD78MZA6	790	4.5	2	70	25	35	0.35	1.9	0.15	37.0	11.0	3			
RLD78MZM7	792	20	2	60	11	33	0.65	1.8	0.50	24.0	8.5	15			
RLD78NZM5	793	10	2	60	10	20	0.55	1.8	1.15	28.0	9.0	6			
RLD78NZM7	792	20	2	60	11	33	0.65	1.8	0.90	24.0	8.5	15			
RLD82NZJ1	822	220	2	60	50	255	0.95	2.4	0.30	17.0	9.5	200			
RLD84NZJ2	842	220	2	60	40	250	0.95	2.4	0.40	19.0	9.5	200			
RLD85NZJ4	852	220	2	60	40	250	0.95	2.4	0.40	19.0	9.5	200			
RLD94NZJ7	942	220	2	60	40	300	0.75	2.4	1.00	17.0	9.5	200			
RLD78PZM7	792	20	2	60	11	33	0.65	1.8	0.65	24.0	8.5	15			
RLD82PZJ1	822	220	2	60	50	255	0.95	2.4	0.30	17.0	9.5	200			
RLD84PZJ2	842	220	2	60	40	250	0.95	2.4	0.40	19.0	9.5	200			
RLD85PZJ4	852	220	2	60	40	250	0.95	2.4	0.40	19.0	9.5	200			
RLD94PZJ5	942	285	2	65	55	325	0.75	2.2	0.90	30.0	35.0	200			

Note: Unless otherwise specified, the Electrical and Optical Characteristics are typical values.

DANGER

INVISIBLE LASER
RADIATION-AVOID
DIRECT EXPOSURE TO BEAM

MAXIMUM OUTPUT: 500 mW
WAVELENGTH: 780 to 980nm
CLASS IIb LASER PRODUCT







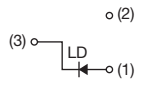

INVISIBLE SEMICONDUCTOR LASER

AVOID EXPOSURE: invisible laser radiation is emitted from this aperture

ROHM Laser Diode



This product complies with 21 CFR Part 1040.10 and 1040.11

ROHM Co., Ltd.
2-1-30th Floor, Midori-ku, Yokohama City
415-8585, Japan

High Power Infrared Lasers														
Part No.	Wavelength λ_p (nm)	Absolute Maximum Ratings ($T_c=25^\circ\text{C}$)			Electrical and Optical Characteristics ($T_c=25^\circ\text{C}$)							Measurement pulse condition	Package	Equivalent Circuit
		P_o (W)	I_F (A)	T_{opr} Max ($^\circ\text{C}$)	P_o (W)	I_{TH} (A)	I_{op} (A)	V_{op} (V)	θ_{\perp} (deg)	$\theta_{//}$ (deg)	Emission area ($\mu\text{m}\times\mu\text{m}$)			
☆RLD90QZW7	905	6	6	85	5	0.4	5	4	20	13	70×2	Pulse width 50ns duty 0.05%		
New RLD90QZWJ		25	9		25	0.4	9	15	20	14	50×10			
☆RLD90QZWB		30	11		25	0.4	9	13	25	14	50×10			
RLD90QZW5		25	9		25	0.4	9	14	25	12	70×10			
☆RLD90QZWC		30	11		25	0.4	9	12	25	13	70×10			
New RLD90QZWD		40	13		35	0.4	12	11	25	13	100×10			
New RLD90QZW3		90	30		75	0.9	27	16	25	10	225×10			
☆RLD90QZW8		145	50		120	1	40	16	25	10	270×10			

Note: Unless otherwise specified, the Electrical and Optical Characteristics are typical values.

☆: Under Development

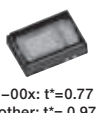
High Power Infrared VCSEL *													
Part No.	Wavelength λ_p (nm)	Electrical and Optical Characteristics ($T_c=25^\circ\text{C}$)							Emission area (mm×mm)	Measurement pulse condition	Package	Equivalent Circuit	
		P_o (mW)	I_F (mA)	V_F (V)	I_{TH} (mA)	PCE (%)	θ (deg×deg)	η (W/A)					
☆RLD94SAQ6	940	200	300	2	70	33	13×13	0.85	0.41×0.23	Pulse width 800 μs 1shot			
☆RLD94SAQ8	940	2,000	3,000	2	750	40	-00x: 20×20 -10x: 60×45 -20x: 72×55 -30x: 90×69 -40x: 110×85	1	1.10×0.82	Pulse width 400 μs 1shot			

Note: Unless otherwise specified, the Electrical and Optical Characteristics are typical values.
*Bare chip sales are also possible. Please contact to ROHM's sales department.

☆: Under Development

●Safety

The light emitted from laser diodes, can cause retinal damage if viewed directly. Never look directly into the laser beam or through any lenses or fibers when the system is operating. For optical axis alignment or other operations, we recommend the use of an infrared-sensitive camera (ITV) or wearing protective goggles.



The products described in this specification are designed to be used with ordinary electronic equipment or devices (such as audio-visual equipment, office-automation equipment, communication device, electrical appliances, and electronic toys). If you intend to use these products or devices which require an extremely high level of reliability and malfunction of which would directly endanger human life (such as medical instruments, transportation equipment, aerospace machinery, nuclear-reactor controllers, fuel controllers and other safety devices), please be sure to consult with our sales representative in advance.

● Part Numbers

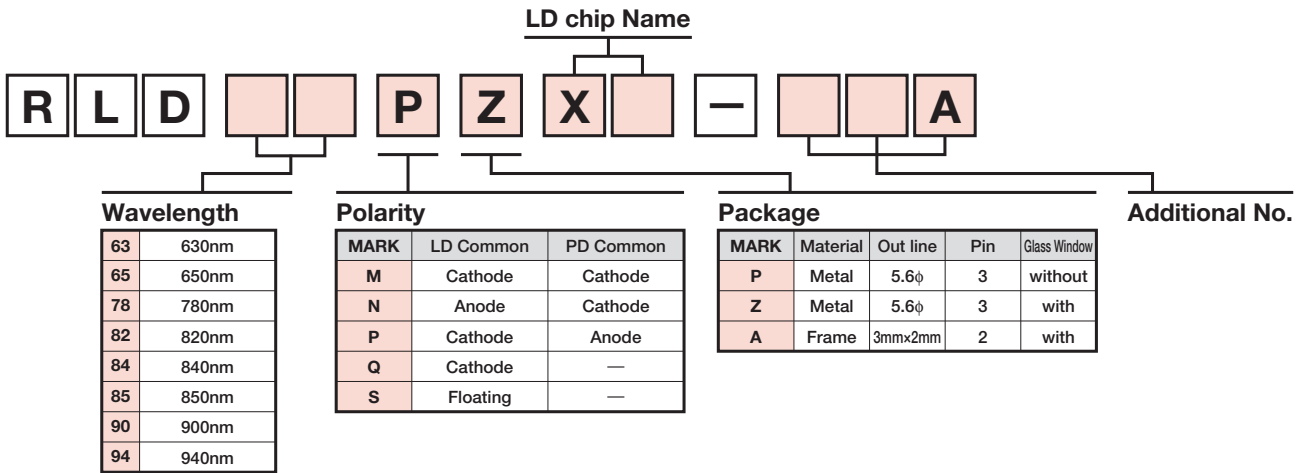

● Symbols and Definitions

■ Absolute Maximum Ratings

Absolute maximum ratings are values which must not be exceeded even momentarily regardless of external conditions. These values are specified for a case temperature T_c of 25°C.

Parameter	Symbol	Definition
Optical Output	P_o	Maximum allowable optical output during continuous or pulse operation. No kinks will appear in the output vs. forward current curve up to this output value. (Fig.1)
Reverse Voltage	V_R	The maximum allowable voltage when a reverse bias is applied to the device. Lasers and photo diodes are rated separately.
Operating Temperature	T_{opr}	Allowed ambient temperature range when the device is in operation. Defined to be the case temperature of the device.
Storage Temperature	T_{stg}	Allowed temperature range when the device is being stored.

■ Fig.1 Optical Output vs. Forward Current

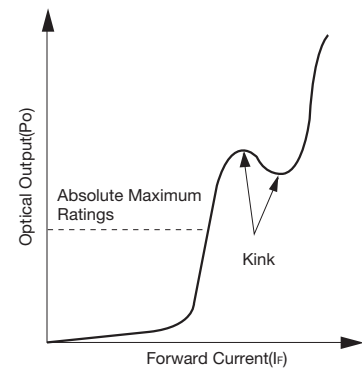

■ Electrical and Optical Characteristics

Item	Symbol	Definition
Threshold Current	I_{TH}	In Fig.2, A is the spontaneous emission range and B is the stimulated emission range. The threshold current is the current at which laser emission begins.
Operating Current	I_{OP}	The forward current required to generate the specified optical output.
Operating Voltage	V_{OP}	The forward voltage required to generate the specified optical output.
Differential Efficiency	η	The average increase in the output per unit of drive current. In the laser emission range, this is the slope of the linear optical output vs. forward current curve. (Fig.2)
Monitor Current	I_m	When the specified optical output is generated, this is the output current of the photodiode when a specified reverse voltage is applied to the monitor photodiode.
Parallel Divergence Angle Perpendicular Divergence Angle	$\theta_{//}$ θ_{\perp}	Light emitted from the laser spreads as shown in Fig.3. The result of measurements of this spread in the parallel (x) and perpendicular (y) directions with respect to the junction surface is shown in Fig.3. The widths of the spread at the points where the strength drops to 1/2 the peak strength (half value full angles) are defined as angles and called $\theta_{//}$ and θ_{\perp} . (Fig.4)
Parallel Deviation Angle Perpendicular Deviation Angle	$\Delta\phi_{//}$ $\Delta\phi_{\perp}$	These values express the deviation of the optical axis with respect to the reference plane, and are defined for the parallel and perpendicular spread angles (Fig.4) to be (a - b)/2 (Fig.5).
Emission Point Accuracy	$\Delta X, \Delta Y, \Delta Z$	This indicates the amount of deviation of the emission point. ΔX and ΔY indicate deviation from the center of the package, and ΔZ indicates deviation from the reference plane. (Fig.6)
Peak Emission Wavelength	λ	Peak emission wavelength when generating the specified output. As shown in Fig.7, the emission spectrum has both a single mode and a multimode. In the multimode, the wavelength is defined as the wavelength with the highest intensity.
Power Conversion Efficiency	PCE	This indicates the ratio of optical output to input electric power.

■ Fig.2 Optical Output vs. Forward Current

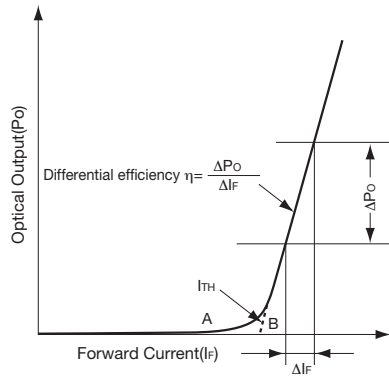

■ Fig.3 Radiation Characteristics

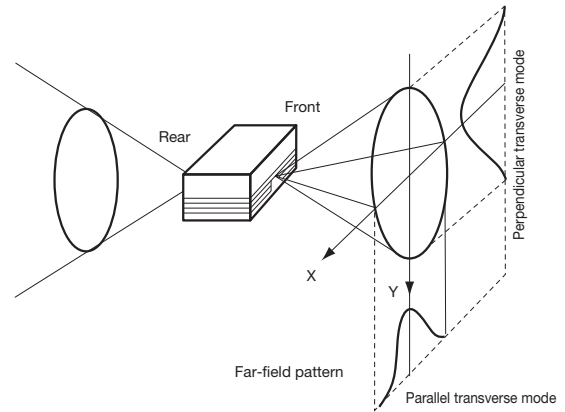

■ Fig.4 Radiation Characteristics

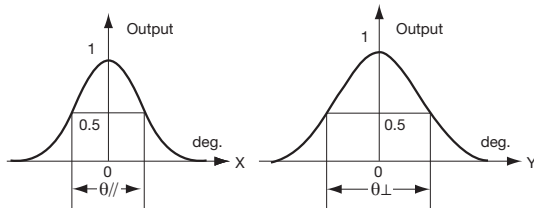

■ Fig.5 Deviation Angle

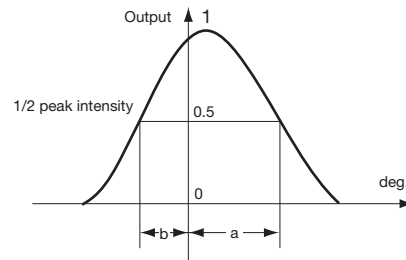

■ Fig.6 Deviation Angle

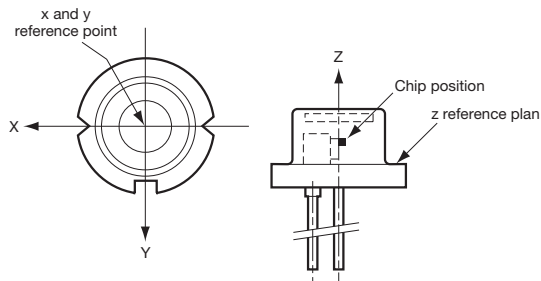

■ Fig.7 Emission Spectrum

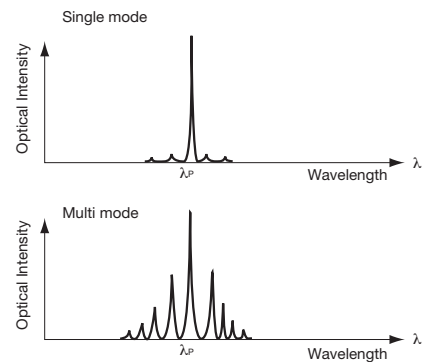

Packaging Specifications

●Dimensions (Unit: mm)

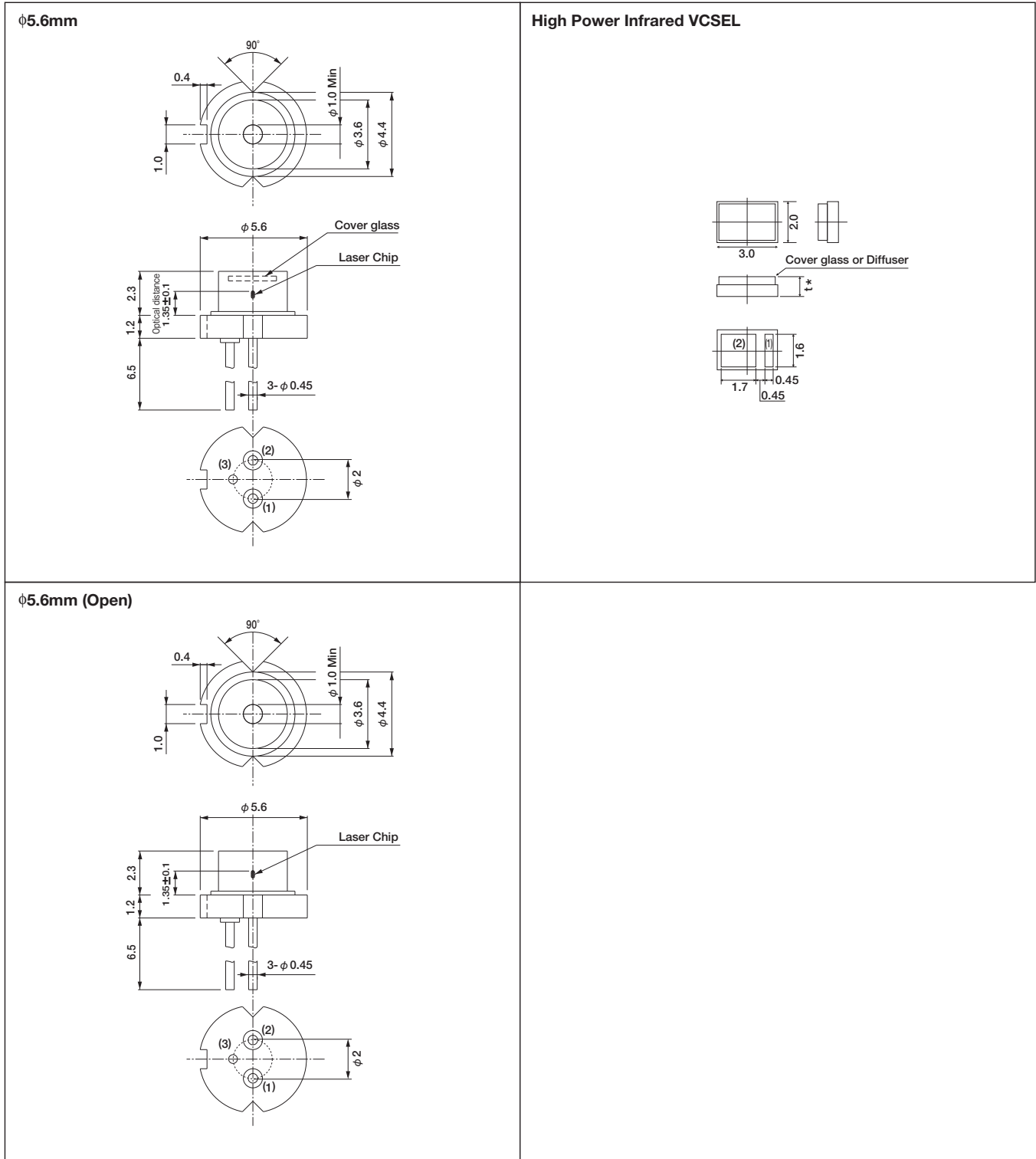

*Please note that differences may exist depending on the part number. Therefore, it is strongly recommended that the customer verify the actual specifications before usage.