

Meets the demand for the miniaturization of high-current detection circuits

Ultra-Low Ohmic (0.5/1/1.5m Ω)
High Power (5W) Flat Chip Type
6432 size Shunt Resistors

PMR100HQP7

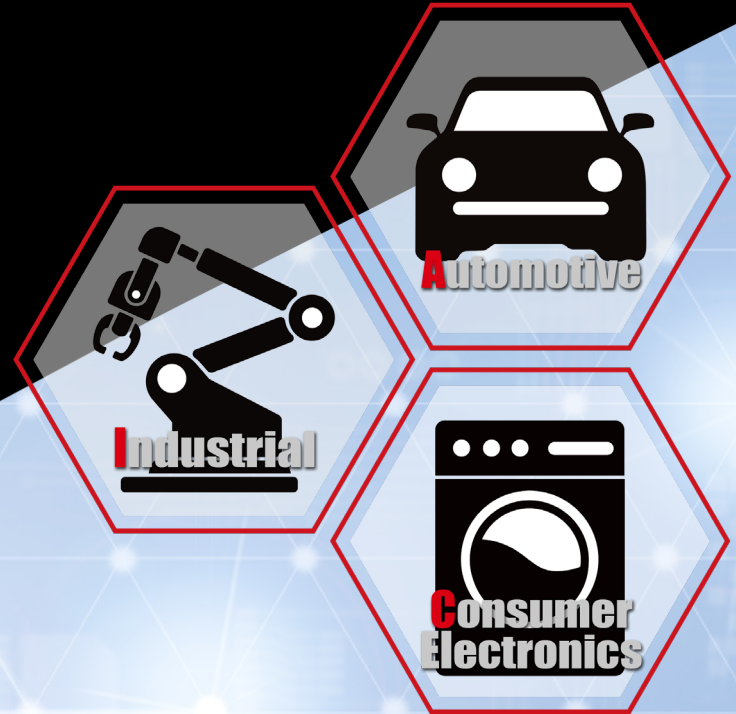

The PMR100HQP7 is a high-power 6432-size (6.4mm × 3.2mm) model within the PMR series – part of ROHM’s standard metal plate shunt resistor lineup. Features such as a compact size, ultra-low resistance, and high-power capability make it possible to meet the need for greater miniaturization of large current detection circuits in automotive and industrial equipment applications.

Features

- **Achieves a rated power of 5W and rated terminal temperature of 130°C (0.5/1mΩ models)**
Flat chip type with protective film achieves class-leading* rated power in the 6432 size, contributing to application miniaturization
- **Proprietary trimming-less structure ensures a distance of 1.6mm (Typ) or more between electrodes**
Facilitates current detection wiring and pattern design

* ROHM March 2024 study

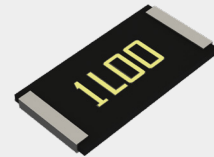

PMR100HQP7
6432 (2512)

unit: mm (inch)

Rated Power Comparison

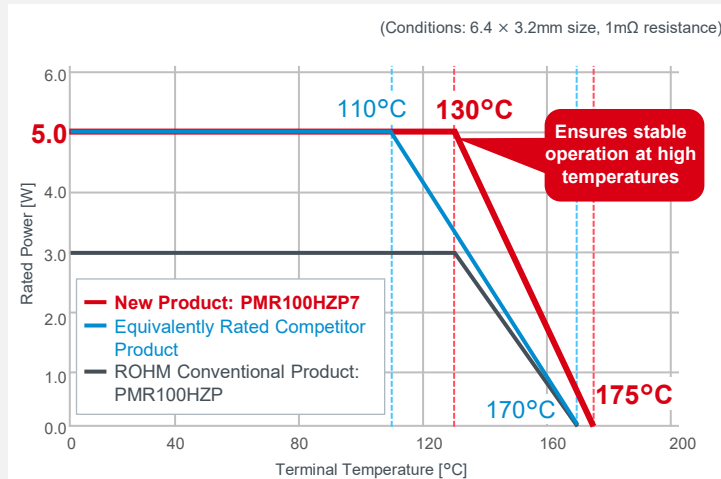

Flat chip type with protective film achieves class-leading* rated power of 5W in the 6432 size

Comparison of Current Detection Circuit Area

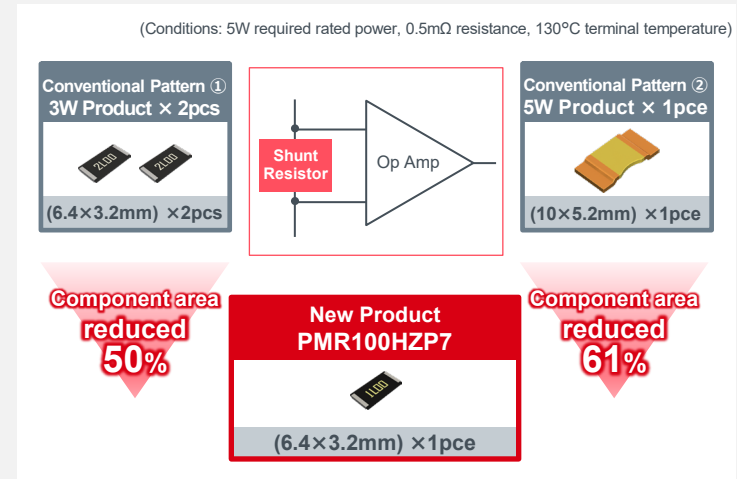

Contributes to application miniaturization

* ROHM March 2024 study

Proprietary Trimming-less Structure Ensures a Distance of 1.6mm (Typ) or More Between Electrodes

Comparison of Electrode Distance: vs Equivalently Rated Competitor Product

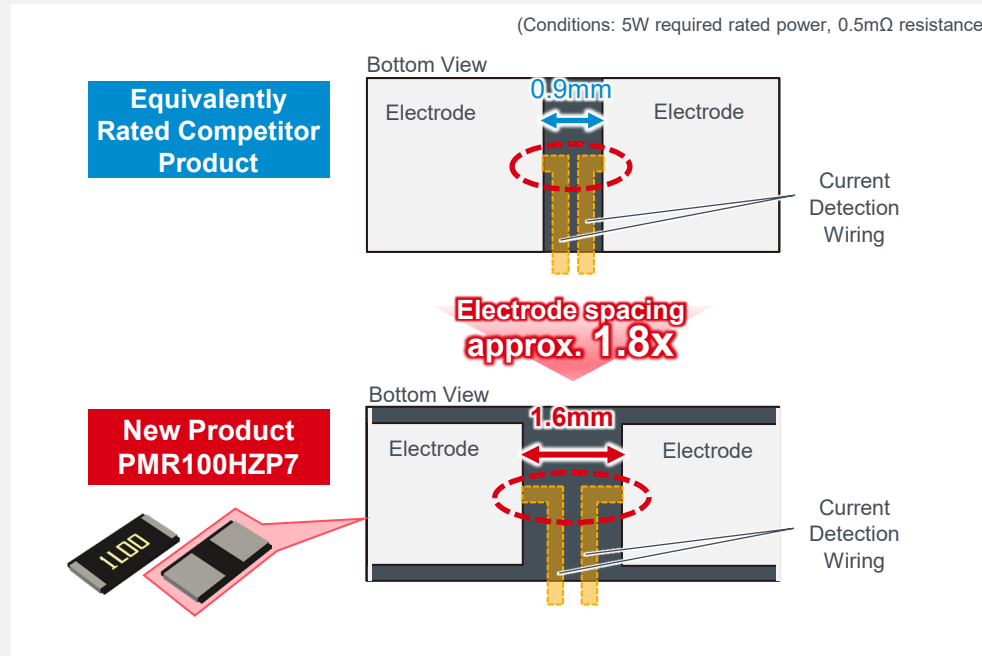

Facilitates current detection wiring and pattern design

ROHM Shunt Resistor series Chart

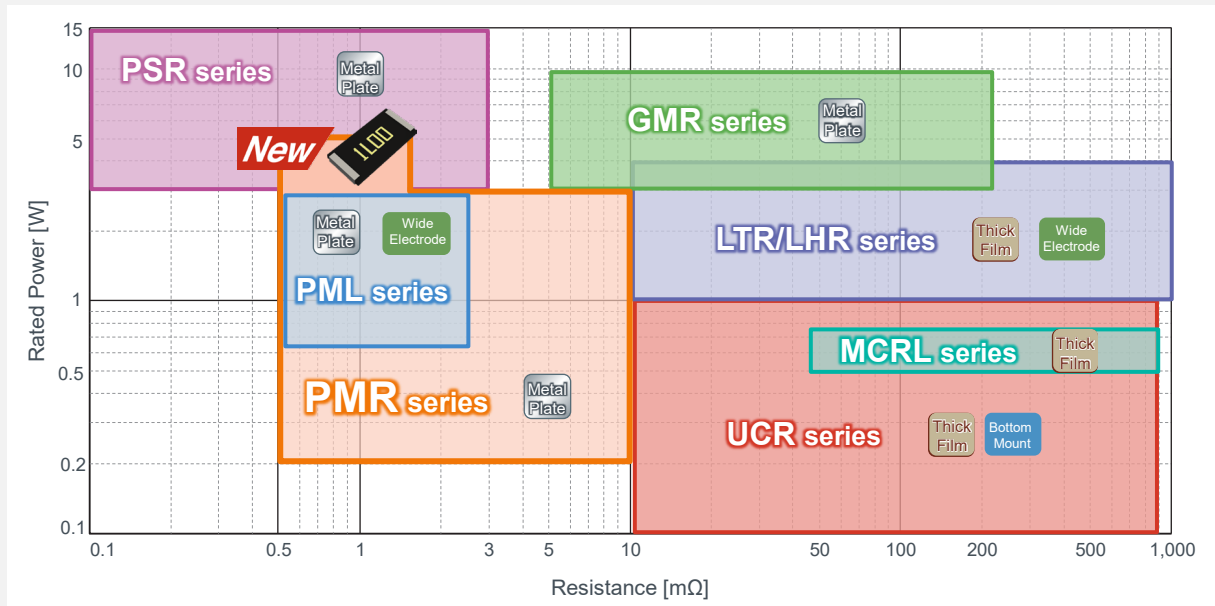

*Click on the series name in the table to access the product page on ROHM's website.

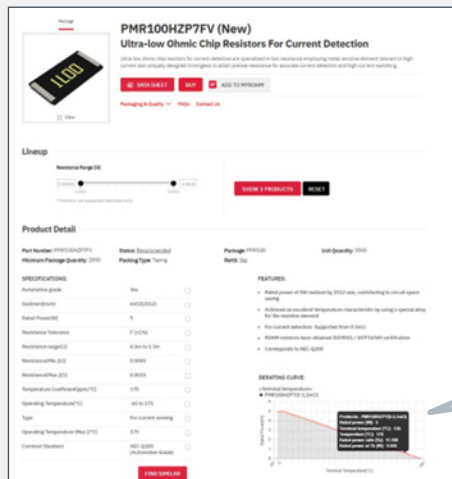

New Product: PMR100HZP7FV

Hover the cursor to display the actual performance values at any ambient/terminal temperature

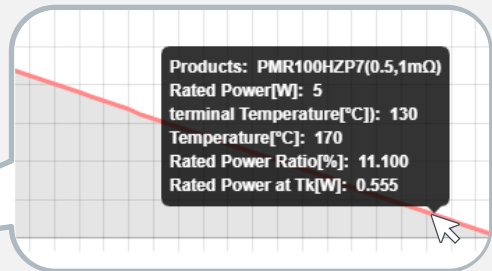

Applicable part numbers are being added
PMR series of Ultra-Low Ohmic Resistors

Application Examples

• Automotive Systems

EPS, electric compressors, pumps, door motors, ADAS controllers, etc.

















• Industrial Equipment



Industrial power modules, power conditioners, power tools, server/base station power supplies, etc.

• Consumer Devices

Home appliances (e.g. air conditioners, vacuum cleaners, refrigerators) etc.

Ultra-Low Ohmic Metal Plate Shunt Resistors: PMR series

Part No.	Size Code [mm] (inch)	Rated Power [W]	Resistance [mΩ]	Rated Ambient Temp. [°C]	Rated Terminal Temp. [°C]	Resistance Tolerance	Temperature Coefficient of Resistance [ppm/°C]	Operating Temp. [°C]	Automotive-Grade AEC-Q200
PMR01ZZP  	1005 (0402)	0.2	10	70	—	J (±5%)	0 to 200	-55 to +155	YES
PMR03EZP  	1608 (0603)	0.25	10	70	—	F (±1%) J (±5%)	0 to 150	-55 to +155	YES
PMR10EZP  	2012 (0805)	1	2	—	130	F (±1%) J (±5%)	±100	-65 to +155	YES
		0.5	3, 4, 5, 6, 7, 8, 9, 10	70	—		±150	-55 to +155	
PMR18EZP  	3216 (1206)	1.5	1, 2	—	130	F (±1%) J (±5%)	±100	-65 to +155	YES
		1	3, 4, 5, 6, 7, 8, 9, 10	70	—			-55 to +155	
PMR25HZP  	3225 (1210)	2	1	—	130	F (±1%) J (±5%)	±75	-65 to +175	YES
		1	2, 3, 4, 5	70	—		±100	-55 to +155	
PMR50HZP  	5025 (2010)	2	1, 2	—	130	F (±1%) J (±5%)	±75	-65 to +175	YES
		1	3, 4, 5, 6, 7, 8, 9, 10	70	—		±100	-55 to +155	
New PMR100HZP7  	6432 (2512)	5	0.5, 1	—	130	F (±1%)	±75	-65 to +175	YES
			1.5		125				
PMR100HZP  	6432 (2512)	3	1.2	—	130	F (±1%) J (±5%)	±75	-65 to +175	YES
		2	3, 4, 5, 6, 7, 8, 9, 10	70	—	F (±1%) J (±5%)	±100	-55 to +155	

Click on the  icon to access the product page and the  icon to view the datasheet on ROHM's website.

Notice

- The information contained in this document is intended to introduce ROHM Group (hereafter referred to as ROHM) products. When using ROHM products, please verify the latest specifications or datasheets before use.
- ROHM does not warrant that the information contained herein is error-free. ROHM shall not be in any way responsible or liable for any damages, expenses, or losses incurred by you or third parties resulting from errors contained in this document.
- The information and data described in this document, including typical application circuits, are examples only and are not intended to guarantee to be free from infringement of third parties intellectual property or other rights. ROHM does not grant any license, express or implied, to implement, use, or exploit any intellectual property or other rights owned or controlled by ROHM or any third parties with respect to the information and data contained herein.
- When exporting ROHM products or technologies described in this document to other countries, you must abide by the procedures and provisions stipulated in all applicable export laws and regulations, such as the Foreign Exchange and Foreign Trade Act and the US Export Administration Regulations, and follow the necessary procedures in accordance with these provisions.
- No part of this document may be reprinted or reproduced in any form by any means without the prior written consent of ROHM.
- The information contained in this document is current as of March 2024 and is subject to change without notice.



ROHM Co.,Ltd.

21 Saiin Mizosaki-cho, Ukyo-ku,
Kyoto 615-8585 Japan

www.rohm.com