

| | |
|---------------------|------|
| V_{DSS} | 750V |
| $R_{DS(on)}$ (Typ.) | 20mΩ |
| I_D^{*1} | 69A |
| P_D | 208W |

● Features

- 1) Qualified to AEC-Q101
- 2) Wide creepage distance = min.6.66mm
- 3) Low on-resistance
- 4) Fast switching speed
- 5) Fast reverse recovery
- 6) Easy to parallel
- 7) Simple to drive
- 8) Pb-free lead plating ; RoHS compliant

● Application

- Automobile
- Switch mode power supplies

● Outline

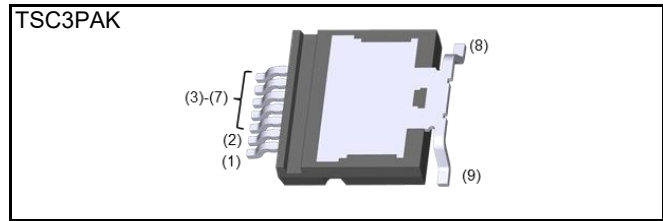

● Inner circuit

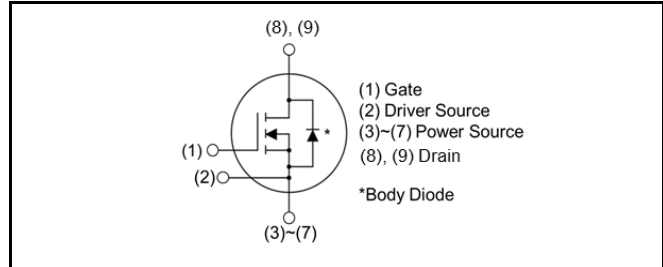

Please note Driver Source and Power Source are not exchangeable. Their exchange might lead to malfunction.

● Packaging specifications

| Type | Packing | Embossed tape |
|------|---------------------------|---------------|
| | Reel size (mm) | 330 |
| | Tape width (mm) | 32 |
| | Basic ordering unit (pcs) | 600 |
| | Taping code | TCR |
| | Marking | SCT4020DTW |

● Absolute maximum ratings ($T_{vj} = 25^\circ\text{C}$ unless otherwise specified)

| Parameter | | Symbol | Value | Unit | |
|--|--|-----------------------|---------------------------|------------------|---|
| Drain - source voltage | | V_{DSS} | 750 | V | |
| Continuous drain and source current | $V_{GS} = V_{GS_{on}}$ | I_D, I_S^{*1} | $T_c = 25^\circ\text{C}$ | 69 | A |
| | | | $T_c = 100^\circ\text{C}$ | 49 | A |
| Pulsed drain current | $V_{GS} = V_{GS_{on}}$ | $I_{D,pulse}^{*2}$ | 163 | A | |
| Body diode pulsed forward current | $T_c = 25^\circ\text{C}$ $V_{GS} = 0\text{V}$ | $I_{S,pulse}^{*1,*3}$ | 69 | A | |
| Body diode surge forward current | | $I_{S,pulse}^{*1,*4}$ | 163 | A | |
| Gate - source voltage (DC) | | V_{GSS_DC} | -4 to +21 | V | |
| Gate - source surge voltage ($t_{surge} < 300\text{ns}$) | | $V_{GSS_surge}^{*5}$ | -4 to +23 | V | |
| Recommended turn-on gate - source drive voltage | | $V_{GS_{on}}^{*6}$ | +15 to +18 | V | |
| Recommended turn-off gate - source drive voltage | | $V_{GS_{off}}$ | 0 | V | |
| Virtual junction temperature | | T_{vj} | 175 | $^\circ\text{C}$ | |
| Range of storage temperature | | T_{stg} | -40 to +175 | $^\circ\text{C}$ | |

● **Electrical characteristics** ($T_{vj} = 25^{\circ}\text{C}$ unless otherwise specified)

| Parameter | Symbol | Conditions | Values | | | Unit |
|---|-------------------|--|--------|--------------|-----------|------------------|
| | | | Min. | Typ. | Max. | |
| Drain - Source breakdown voltage | $V_{(BR)DSS}$ | $V_{GS} = 0\text{ V}, I_D = 12.4\text{mA}$ $T_{vj} = 25^{\circ}\text{C}$ | 750 | - | - | V |
| Zero Gate voltage Drain current | I_{DSS} | $V_{GS} = 0\text{ V}, V_{DS} = 750\text{V}$ $T_{vj} = 25^{\circ}\text{C}$ $T_{vj} = 150^{\circ}\text{C}$ | - | 1 10 | 80 - | μA |
| Gate - Source leakage current | I_{GSS+} | $V_{GS} = +21\text{ V}, V_{DS} = 0\text{V}$ | - | - | 100 | nA |
| Gate - Source leakage current | I_{GSS-} | $V_{GS} = -4\text{ V}, V_{DS} = 0\text{V}$ | - | - | -100 | nA |
| Gate threshold voltage | $V_{GS(th)}^{*7}$ | $V_{DS} = 10\text{V}, I_D = 20\text{mA}$ | 2.8 | - | 4.8 | V |
| Static Drain - Source on - state resistance | $R_{DS(on)}^{*8}$ | $V_{GS} = 18\text{V}, I_D = 38\text{A}$ $T_{vj} = 25^{\circ}\text{C}$ $T_{vj} = 150^{\circ}\text{C}$ | - | 20.0 34.2 | 26.0 - | $\text{m}\Omega$ |
| Gate input resistance | R_G | $f = 1\text{MHz}, \text{open drain}$ | - | 1 | - | Ω |

● **Thermal resistance**

| Parameter | Symbol | Values | | | Unit |
|-------------------------------------|-----------------|--------|------|------|------|
| | | Min. | Typ. | Max. | |
| Thermal resistance, junction - case | R_{thJC}^{*9} | - | 0.55 | 0.72 | K/W |

Important note: The thermal resistance of the entire thermal stack is a critical factor for correct T_j estimation. Relying solely on the datasheet R_{thJC} value and assuming a constant case temperature when comparing different devices can lead to misleading results. For more information, please refer to "[application note 68AN036E](#)".

● **Typical Transient Thermal Characteristics**

| Symbol | Value | Unit | Symbol | Value | Unit |
|-----------|----------------------|------|-----------|----------------------|------|
| R_{th1} | 8.0×10^{-2} | K/W | C_{th1} | 7.8×10^{-4} | Ws/K |
| R_{th2} | 2.1×10^{-1} | | C_{th2} | 4.0×10^{-3} | |
| R_{th3} | 2.5×10^{-1} | | C_{th3} | 2.9×10^{-2} | |

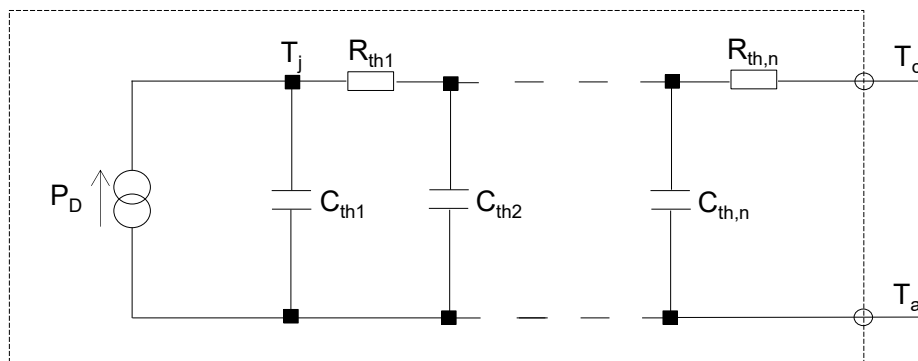

●Electrical characteristics ($T_{vj} = 25^{\circ}\text{C}$ unless otherwise specified)

| Parameter | Symbol | Conditions | Values | | | Unit | |
|--|----------------------------|---|---|------|------|---------------|---------------|
| | | | Min. | Typ. | Max. | | |
| Transconductance | g_{fs}^{*8} | $V_{DS} = 10\text{V}, I_D = 38\text{A}$ | - | 19 | - | S | |
| Input capacitance | C_{iss} | $V_{GS} = 0\text{V}$ | - | 3174 | - | pF | |
| Output capacitance | C_{oss} | $V_{DS} = 500\text{V}$ | - | 155 | - | | |
| Reverse transfer capacitance | C_{rss} | $f = 1\text{MHz}$ | - | 8 | - | | |
| Effective output capacitance, energy related | $C_{o(er)}$ | $V_{GS} = 0\text{V}$ $V_{DS} = 0\text{V to } 500\text{V}$ | - | 203 | - | pF | |
| Total Gate charge | Q_g^{*8} | $V_{DS} = 500\text{V}$ $I_D = 38\text{A}$ | - | 123 | - | nC | |
| Gate - Source charge | Q_{gs}^{*8} | $V_{GS} = 18\text{V}$ | - | 29 | - | | |
| Gate - Drain charge | Q_{gd}^{*8} | See Fig. 1-1, 1-2. | - | 43 | - | | |
| Turn - on delay time | $t_{d(on)}^{*8}$ | $V_{DS} = 500\text{V}$ $I_D = 38\text{A}$ | - | 14 | - | ns | |
| Rise time | t_r^{*8} | $V_{GS} = +18\text{V} / 0\text{V}$ | - | 26 | - | | |
| Turn - off delay time | $t_{d(off)}^{*8}$ | $R_G = 6.8\Omega, L = 250\mu\text{H}$ E_{on} includes diode reverse recovery | - | 53 | - | | |
| Fall time | t_f^{*8} | $L_{\sigma} = 50\text{nH}, C_{\sigma} = 10\text{pF}$ | - | 14 | - | | |
| Turn - on switching loss | E_{on}^{*8} | See Fig. 2-1, 2-2, 2-3. | - | 550 | - | μJ | |
| Turn - off switching loss | E_{off}^{*8} | | - | 82 | - | | |
| Short-circuit withstand time | $V_{GS(on)} = +15\text{V}$ | t_{sc}^{*10} | $V_{DS} \leq 400\text{V}$ | - | 12.0 | - | μs |
| | $V_{GS(on)} = +18\text{V}$ | | $V_{DS,peak} \leq 750\text{V}$ $T_{vj(start)} = 25^{\circ}\text{C}$ $R_G = 2.2\Omega$ | - | 11.5 | - | μs |

● **Body diode electrical characteristics** (Source-Drain) ($T_{vj} = 25^{\circ}\text{C}$ unless otherwise specified)

| Parameter | Symbol | Conditions | Values | | | Unit |
|-------------------------------|----------------|--|--------|------|------|------|
| | | | Min. | Typ. | Max. | |
| Forward voltage | V_{SD}^{*8} | $V_{GS} = 0\text{V}, I_S = 38\text{A}$ | - | 3.3 | - | V |
| Reverse recovery time | t_{rr}^{*8} | $I_F = 38\text{A}$ $V_R = 500\text{V}$ | - | 15 | - | ns |
| Reverse recovery charge | Q_{rr}^{*8} | $di/dt = 2600\text{A}/\mu\text{s}$ | - | 210 | - | nC |
| Peak reverse recovery current | I_{rrm}^{*8} | $L_{\sigma} = 50\text{nH}, C_{\sigma} = 10\text{pF}$ See Fig. 3-1, 3-2. | - | 28 | - | A |

*1 Limited by maximum T_{vj} and for Max. R_{thJC} .

*2 Pulse width and duty cycle are limited by $T_{vj,max}$.

*3 Only for body-diode, Repetitive pulse, $PW \leq 1.5\mu\text{s}$, Duty cycle $\leq 5\%$

*4 When used as a protective function, $PW \leq 10\mu\text{s}$

*5 Example of acceptable V_{GS} waveform



*6 Please be advised not to use SiC-MOSFETs with V_{GS} below 10V as doing so may cause thermal runaway.

*7 Tested after applying $V_{GS} = 21\text{V}$ for 100ms.

*8 Pulsed

*9 Measured conformable to JESD51-14.

See the application note "rthjc_measurement_and_usage_an-e.pdf". [Link](#)

URL: https://fscdn.rohm.com/en/products/databook/applnote/discrete/common/rthjc_measurement_and_usage_an-e.pdf

*10 The value is based on TO-247 package. Single Pulsed.

●Electrical characteristic curves

Fig.1 Power Dissipation Derating Curve

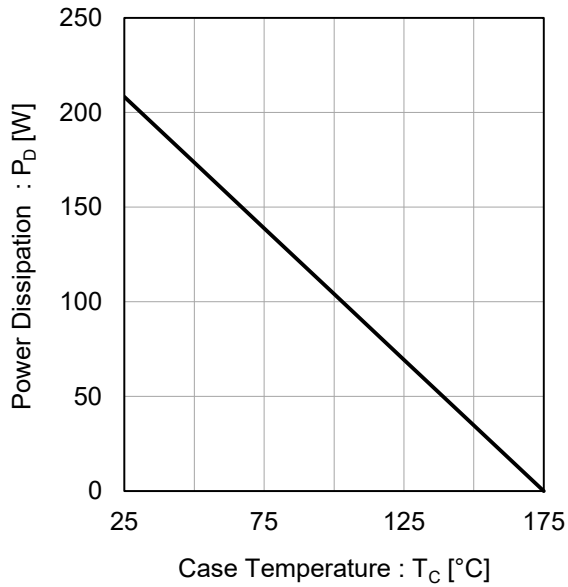

Fig.2 Maximum Safe Operating Area

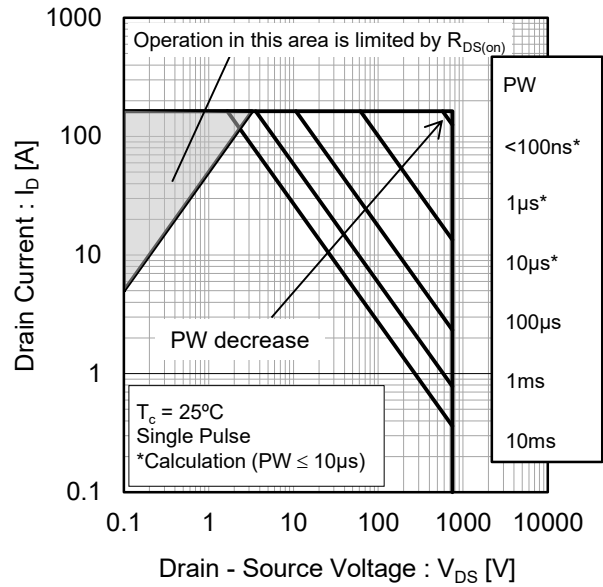
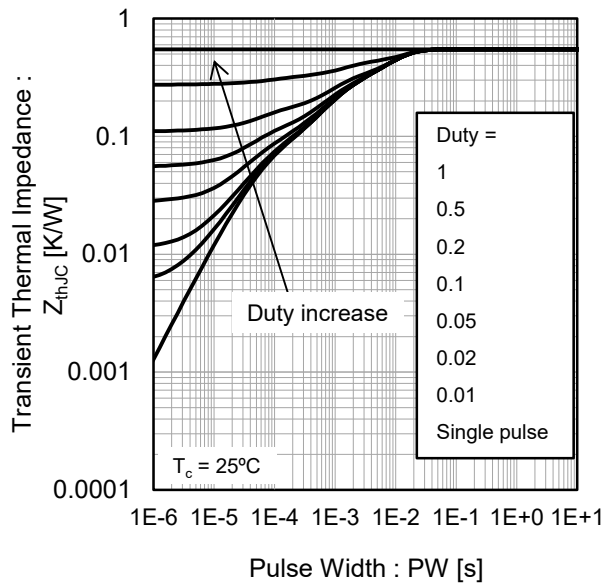

Fig.3 Typical Transient Thermal Impedance vs. Pulse Width



●Electrical characteristic curves

Fig.4 $T_{vj} = 25^{\circ}\text{C}$ Typical Output Characteristics

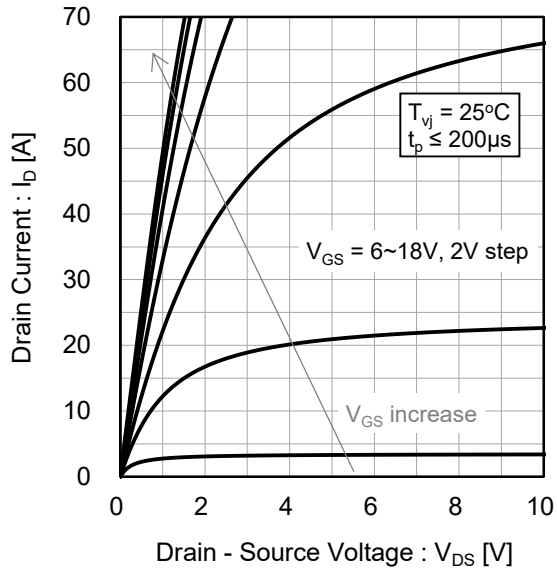
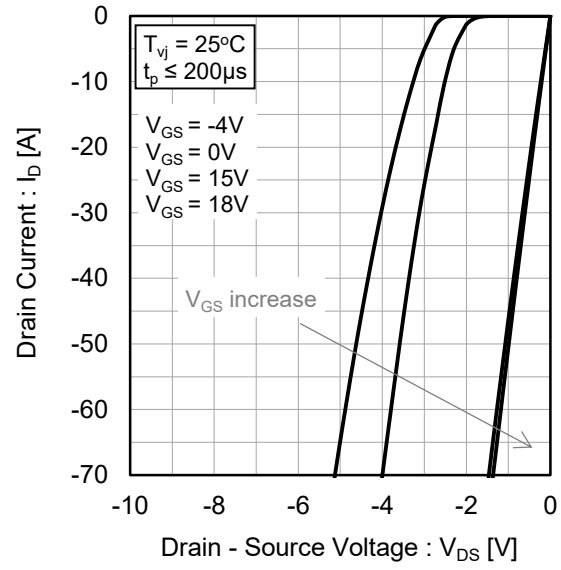

Fig.5 $T_{vj} = 25^{\circ}\text{C}$ 3rd Quadrant Characteristics



●Electrical characteristic curves

Fig.6 $T_{vj} = 150^{\circ}\text{C}$ Typical Output Characteristics

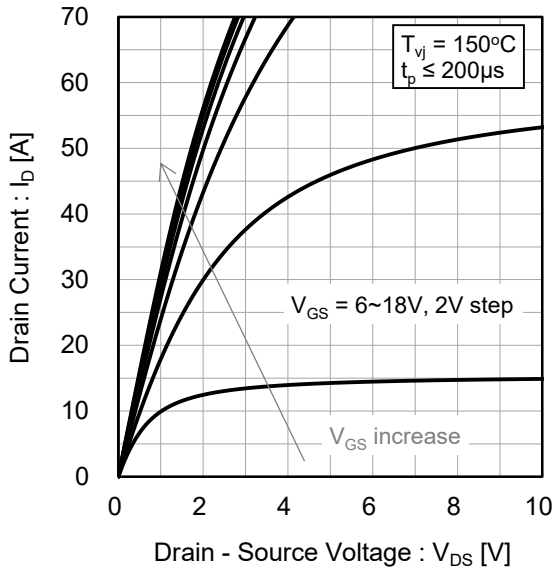

Fig.7 $T_{vj} = 150^{\circ}\text{C}$ 3rd Quadrant Characteristics

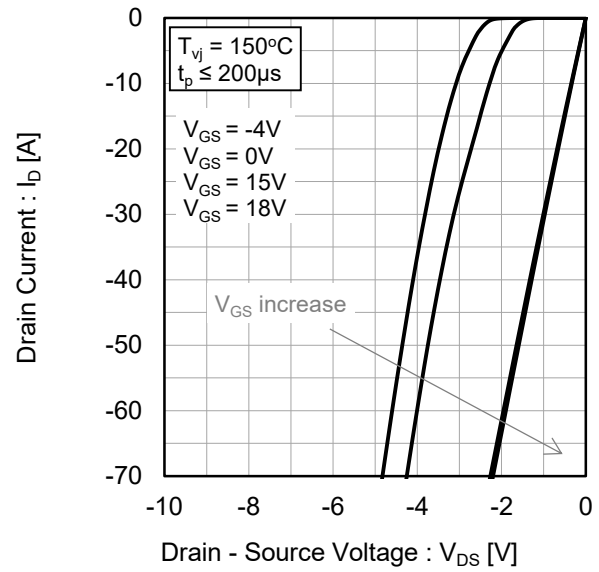
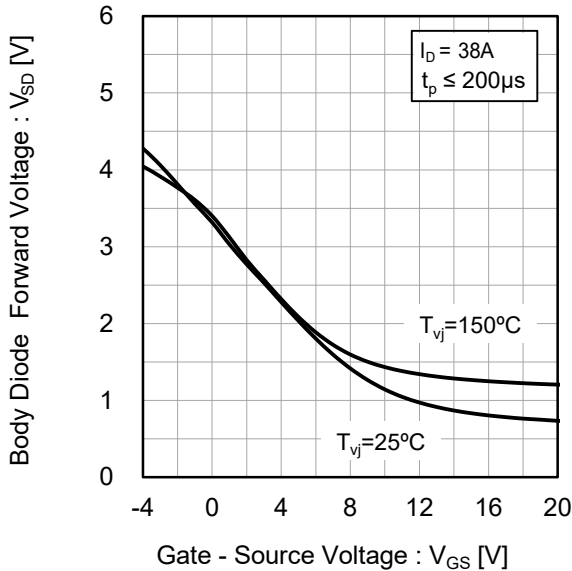

Fig.8 Body Diode Forward Voltage vs. Gate - Source Voltage



●Electrical characteristic curves

Fig.9 Typical Transfer Characteristics (I)

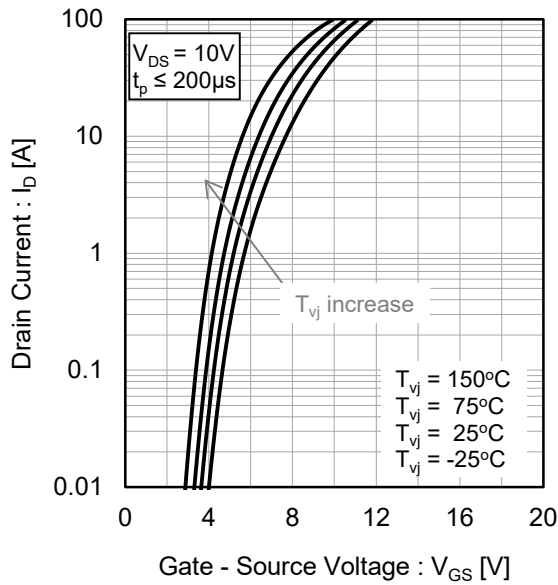

Fig.10 Typical Transfer Characteristics (II)

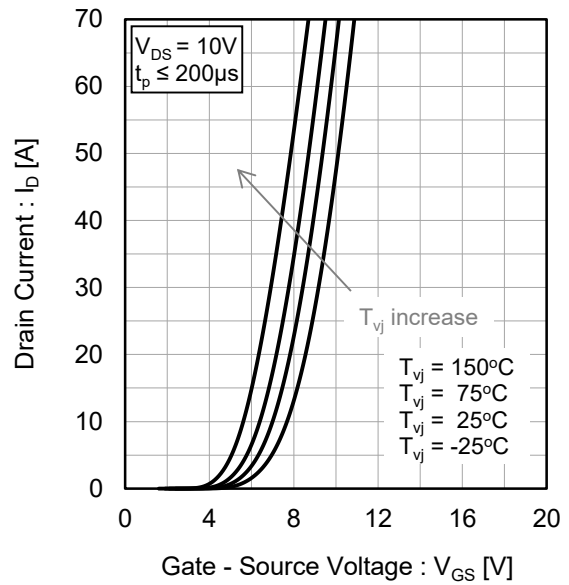

Fig.11 Gate Threshold Voltage vs. Virtual Junction Temperature

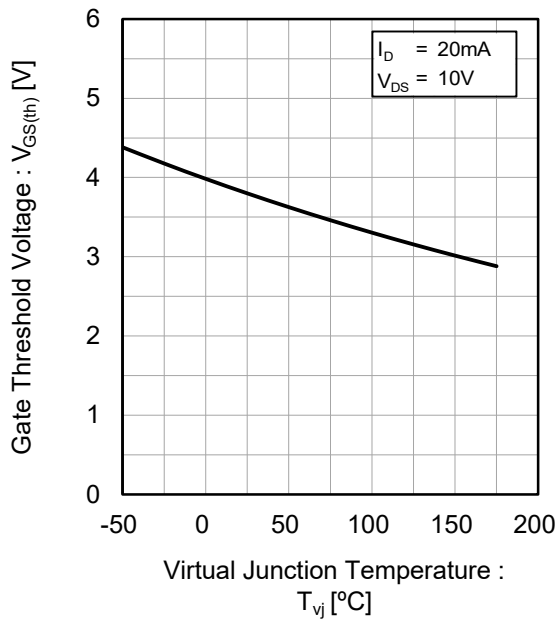
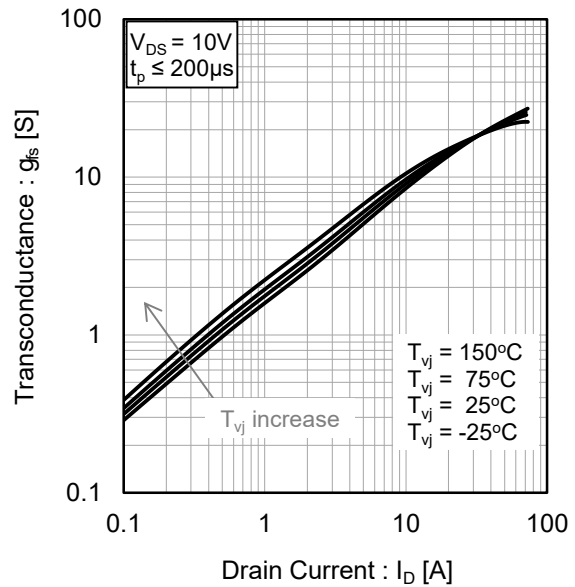

Fig.12 Transconductance vs. Drain Current



●Electrical characteristic curves

Fig.13 Static Drain - Source On - State Resistance vs. Gate - Source Voltage

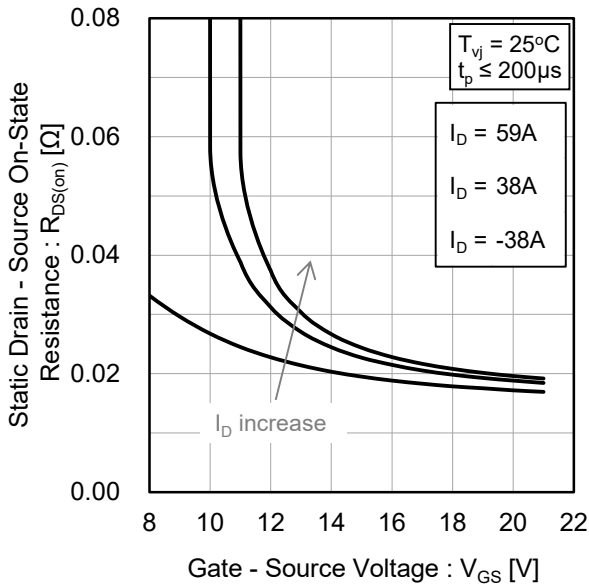

Fig.14 Static Drain - Source On - State Resistance vs. Virtual Junction Temperature

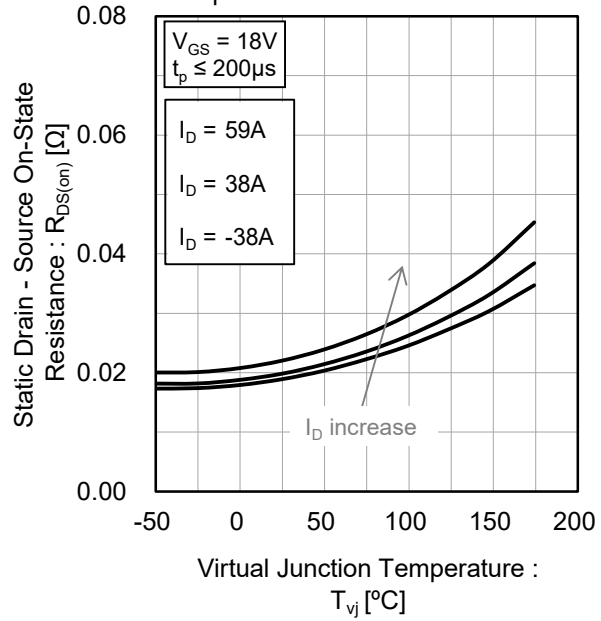

Fig.15 Static Drain - Source On - State Resistance vs. Drain Current

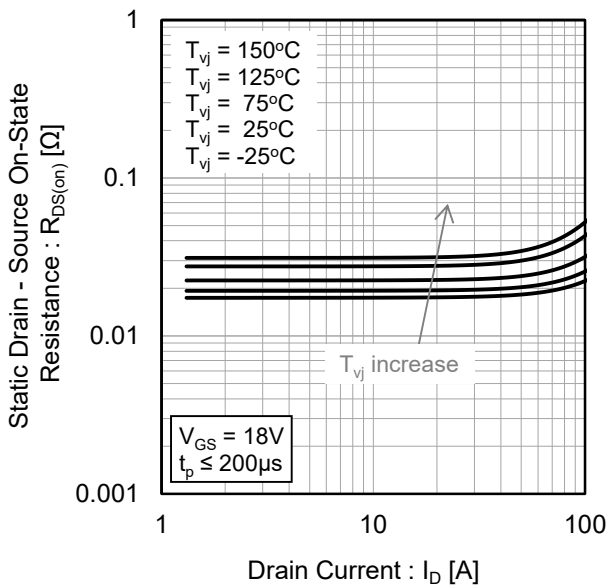
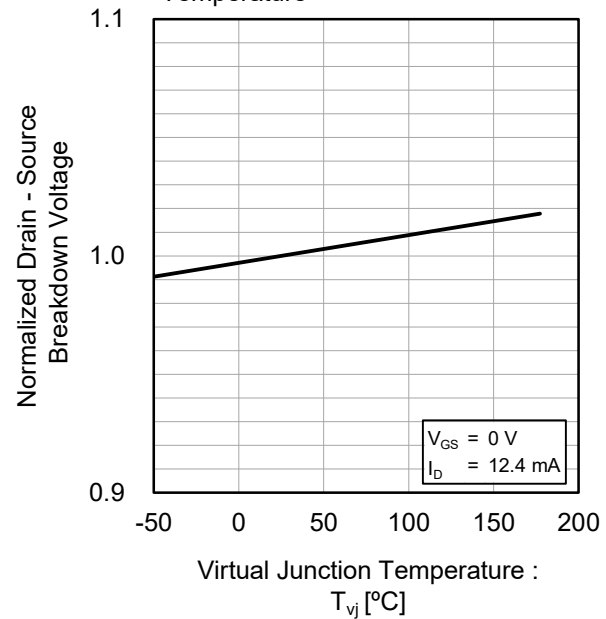

Fig.16 Normalized Drain - Source Breakdown Voltage vs. Virtual Junction Temperature



●Electrical characteristic curves

Fig.17 Typical Capacitance vs. Drain - Source Voltage

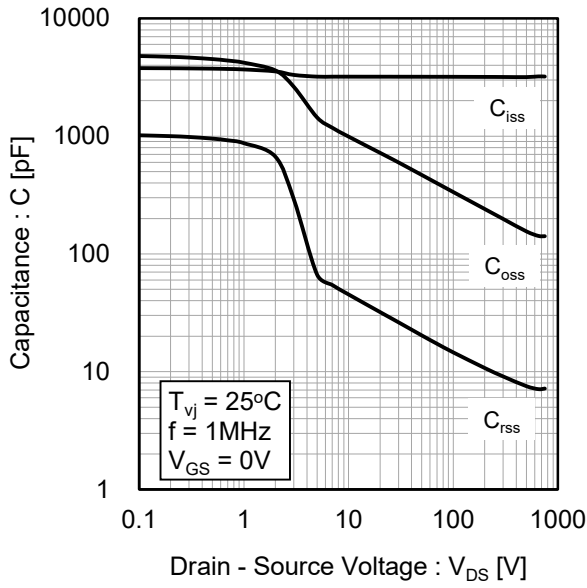

Fig.18 C_{oss} Stored Energy vs. Drain - Source Voltage

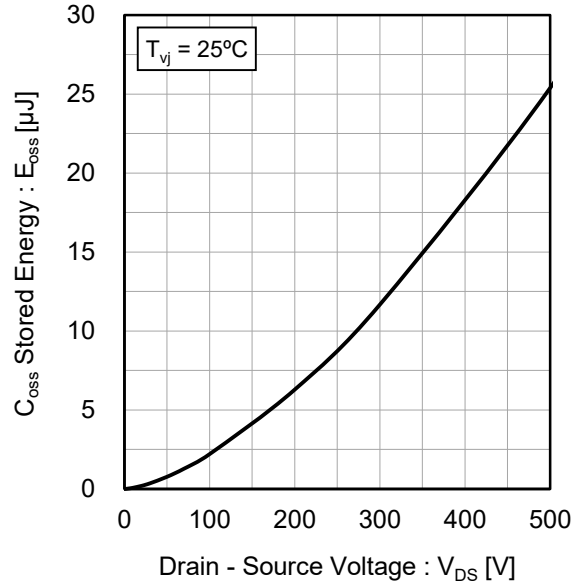
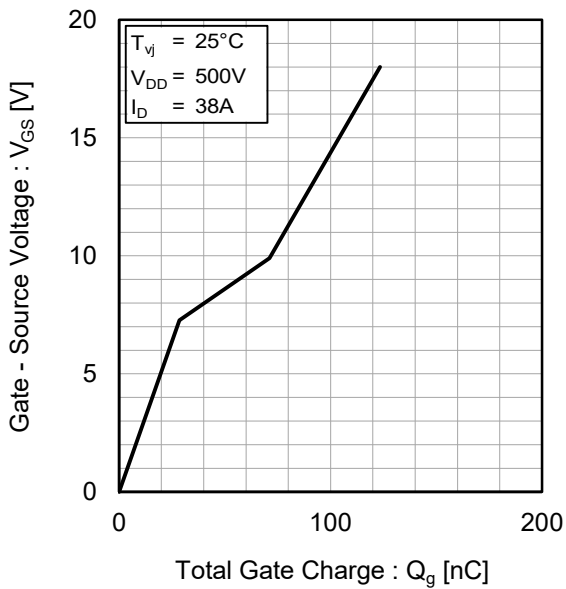

Fig.19 Dynamic Input Characteristics



●Electrical characteristic curves

Fig.20 Typical Switching Time vs. External Gate Resistance

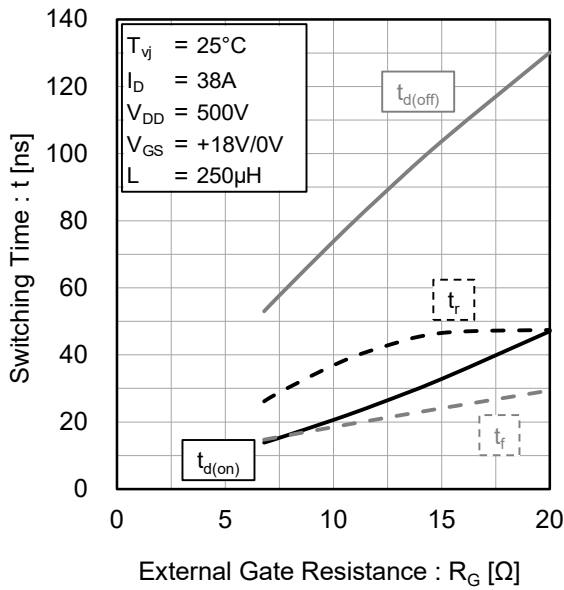

Fig.21 Typical Switching Loss vs. Drain - Source Voltage

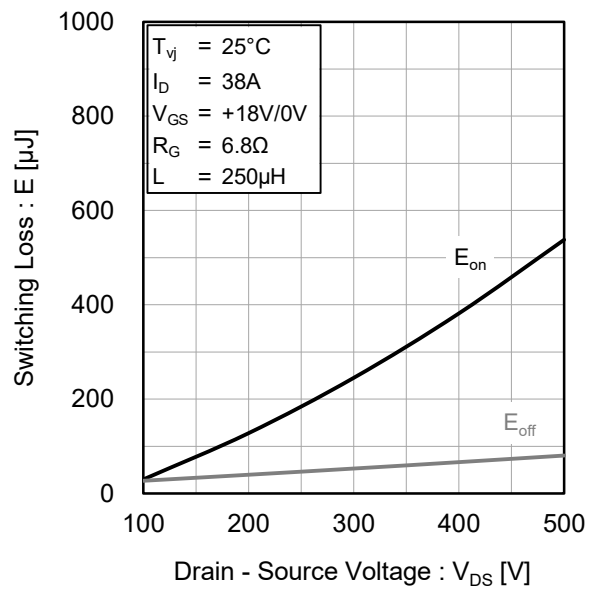

Fig.22 Typical Switching Loss vs. Drain Current

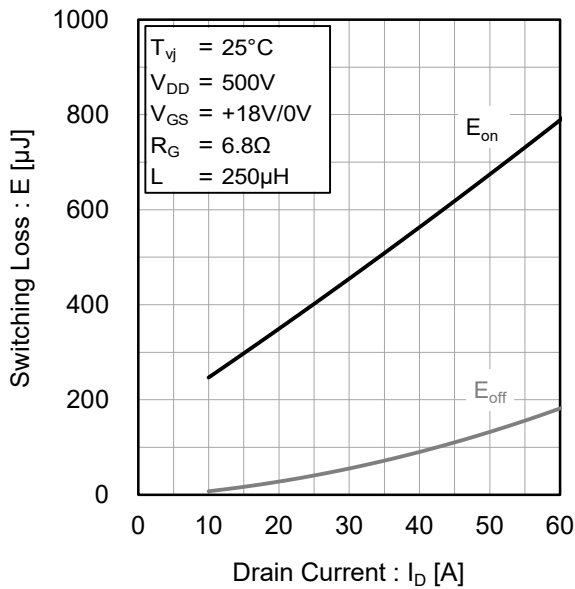
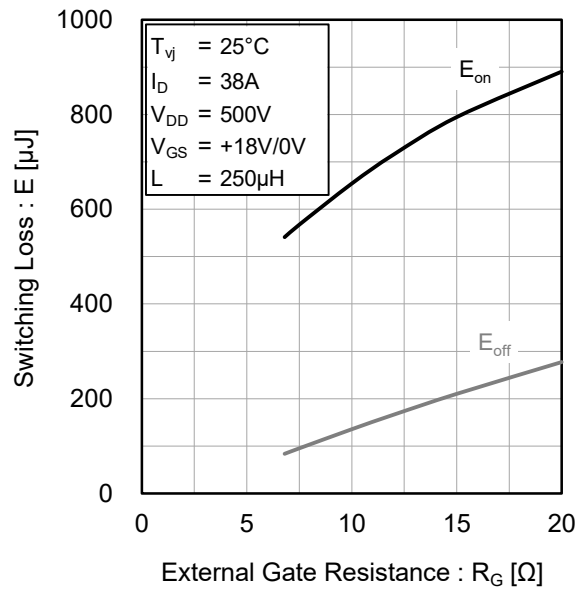

Fig.23 Typical Switching Loss vs. External Gate Resistance



● Measurement circuits and waveforms

Fig.1-1 Gate Charge Measurement Circuit

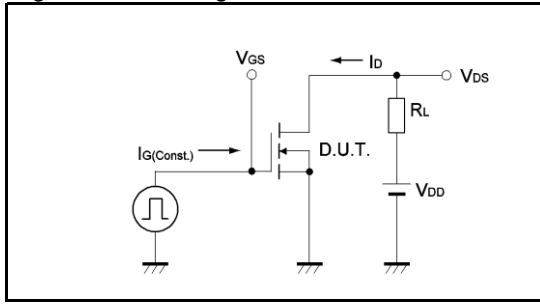

Fig.1-2 Gate Charge Waveform

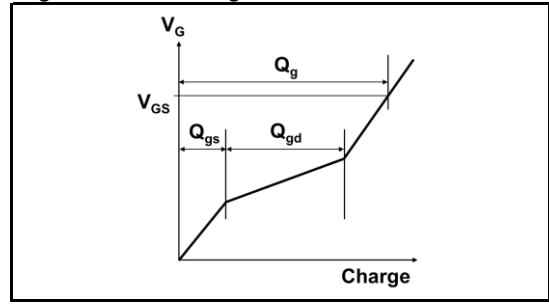

Fig.2-1 Switching Characteristics Measurement Circuit

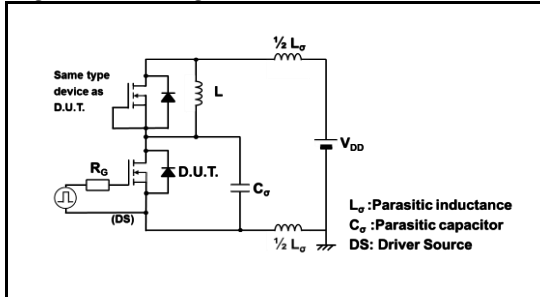

Fig.2-2 Waveforms for Switching Time

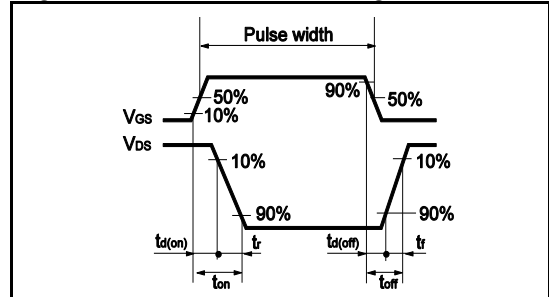

Fig.2-3 Waveforms for Switching Energy Loss

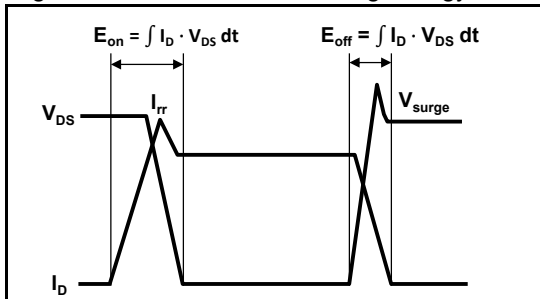

Fig.3-1 Reverse Recovery Time Measurement Circuit

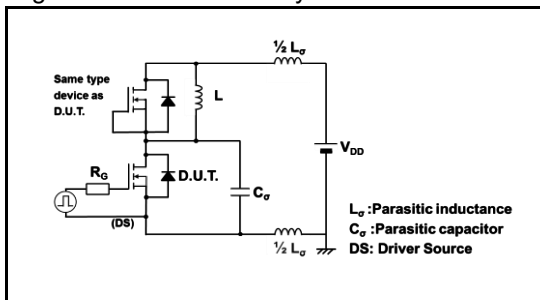
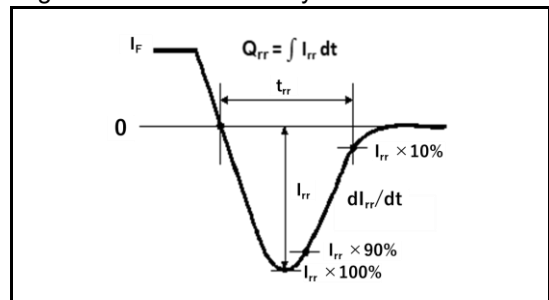
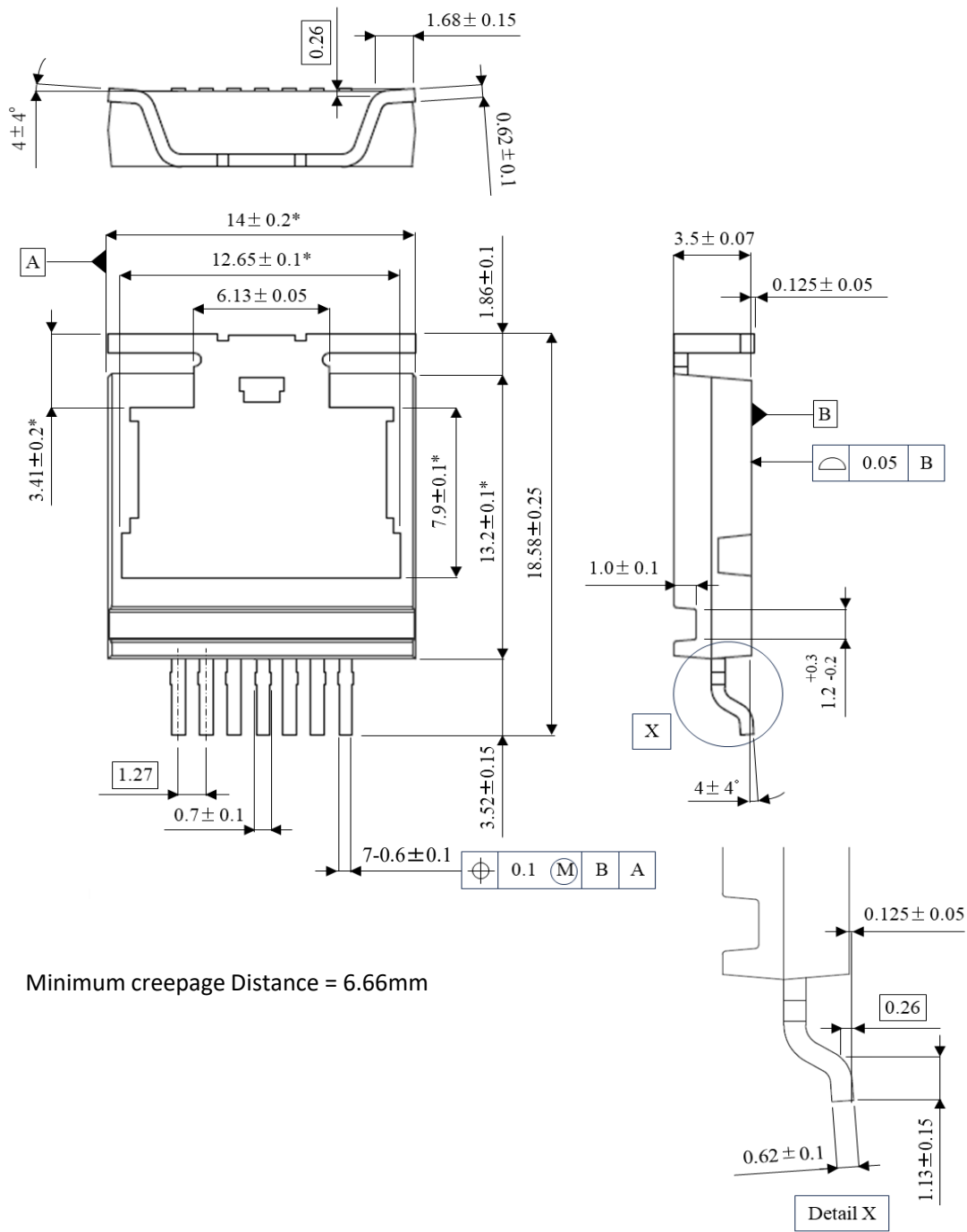

Fig.3-2 Reverse Recovery Waveform



● Package Dimensions



Minimum creepage Distance = 6.66mm

*Does not include resin burrs

Unit: mm

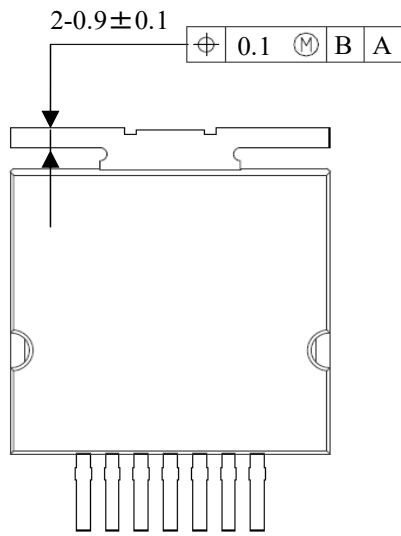

RECOMMENDED FOOTPRINT DIMENSIONS



Unit: mm

●Die Bonding Layout

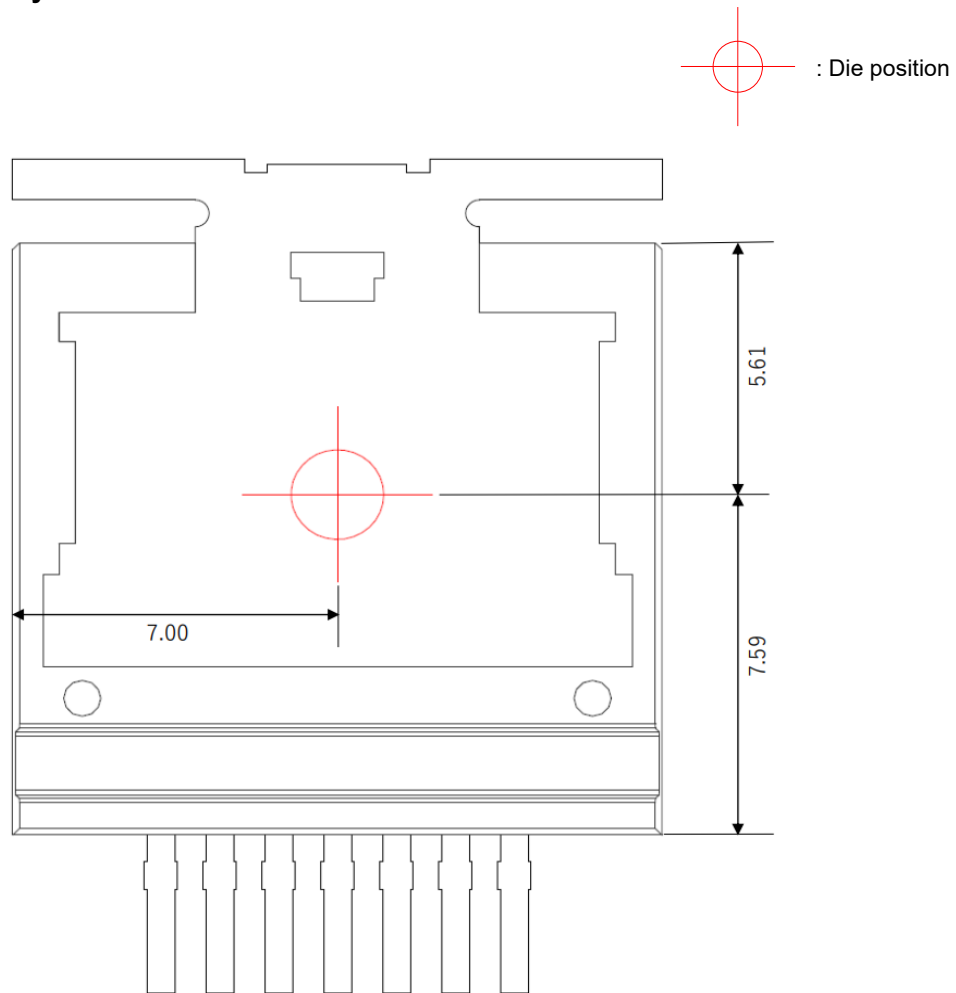

- Front view of the packaging.
- Dimensions are design values.
- If the heat sink is to be installed, it should be in contact with the die bonding point.

Unit: mm

Notes

- 1) The information contained herein is subject to change without notice.
- 2) Before you use our Products, please contact our sales representative and verify the latest specifications.
- 3) Although ROHM is continuously working to improve product reliability and quality, semiconductors can break down and malfunction due to various factors. Therefore, in order to prevent personal injury or fire arising from failure, please take safety measures such as complying with the derating characteristics, implementing redundant and fire prevention designs, and utilizing backups and fail-safe procedures. ROHM shall have no responsibility for any damages arising out of the use of our Products beyond the rating specified by ROHM.
- 4) Examples of application circuits, circuit constants and any other information contained herein are provided only to illustrate the standard usage and operations of the Products. The peripheral conditions must be taken into account when designing circuits for mass production.
- 5) The technical information specified herein is intended only to show the typical functions of and examples of application circuits for the Products. ROHM does not grant you, explicitly or implicitly, any license to use or exercise intellectual property or other rights held by ROHM or any other parties. ROHM shall have no responsibility whatsoever for any dispute arising out of the use of such technical information.
- 6) The Products specified in this document are not designed to be radiation tolerant.
- 7) For use of our Products in applications requiring a high degree of reliability (as exemplified below), please contact and consult with a ROHM representative : transportation equipment (i.e. cars, ships, trains), primary communication equipment, traffic lights, fire/crime prevention, safety equipment, medical systems, and power transmission systems.
- 8) Do not use our Products in applications requiring extremely high reliability, such as aerospace equipment, nuclear power control systems, and submarine repeaters.
- 9) ROHM shall have no responsibility for any damages or injury arising from non-compliance with the recommended usage conditions and specifications contained herein.
- 10) ROHM has used reasonable care to ensure the accuracy of the information contained in this document. However, ROHM does not warrants that such information is error-free, and ROHM shall have no responsibility for any damages arising from any inaccuracy or misprint of such information.
- 11) Please use the Products in accordance with any applicable environmental laws and regulations, such as the RoHS Directive. For more details, including RoHS compatibility, please contact a ROHM sales office. ROHM shall have no responsibility for any damages or losses resulting non-compliance with any applicable laws or regulations.
- 12) When providing our Products and technologies contained in this document to other countries, you must abide by the procedures and provisions stipulated in all applicable export laws and regulations, including without limitation the US Export Administration Regulations and the Foreign Exchange and Foreign Trade Act.
- 13) This document, in part or in whole, may not be reprinted or reproduced without prior consent of ROHM.



Thank you for your accessing to ROHM product informations.
More detail product informations and catalogs are available, please contact us.

ROHM Customer Support System

<http://www.rohm.com/contact/>

General Precaution

1. Before you use our Products, you are requested to carefully read this document and fully understand its contents. ROHM shall not be in any way responsible or liable for failure, malfunction or accident arising from the use of any ROHM's Products against warning, caution or note contained in this document.
2. All information contained in this document is current as of the issuing date and subject to change without any prior notice. Before purchasing or using ROHM's Products, please confirm the latest information with a ROHM sales representative.
3. The information contained in this document is provided on an "as is" basis and ROHM does not warrant that all information contained in this document is accurate and/or error-free. ROHM shall not be in any way responsible or liable for any damages, expenses or losses incurred by you or third parties resulting from inaccuracy or errors of or concerning such information.