

$V_R$	1200V
$I_F$	15A
$Q_C$	47nC

#### ●Features

- 1) High surge current capability
- 2) Low leakage current
- 3) Reduced temperature dependence
- 4) High-speed switching possible
- 5) Shorter recovery time

#### ●Applications

- PV Power Conditioner
- Motor Drive
- Factory Automation
- EV Charger Station

#### ●Outline

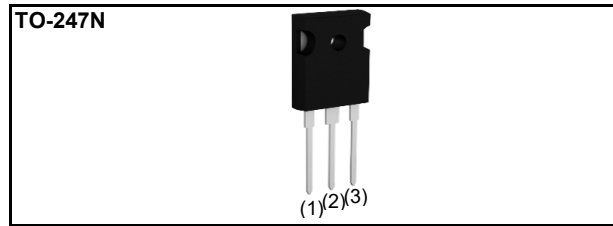

#### ●Inner circuit

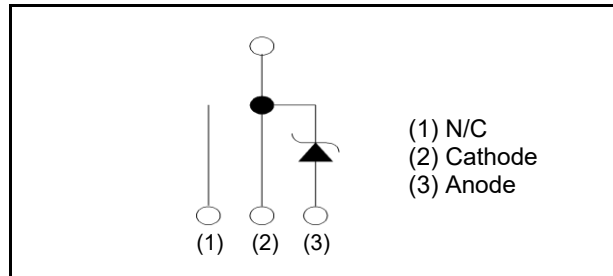

#### ●Packaging specifications

Type	Packaging	Tube
	Reel size (mm)	-
	Tape width (mm)	-
	Basic ordering unit (pcs)	30
	Packing code	C11
	Marking	SCS315KE

#### ●Absolute maximum ratings ( $T_{vj}=25^{\circ}\text{C}$ unless otherwise specified)

Parameter	Symbol	Value	Unit	
Reverse voltage (repetitive peak)	$V_{RM}$	1200	V	
Reverse voltage (DC)	$V_R$	1200	V	
Continuous forward current ( $T_c=140^{\circ}\text{C}$ )	$I_F$	15 *1	A	
Surge non-repetitive forward current	$I_{FSM}$	PW=10ms sinusoidal, $T_{vj}=25^{\circ}\text{C}$	145	A
		PW=10ms sinusoidal, $T_{vj}=150^{\circ}\text{C}$	109	A
		PW=10ms square, $T_{vj}=25^{\circ}\text{C}$	570	A
Repetitive peak forward current	$I_{FRM}$	68 *2	A	
$i^2t$ value	$\int i^2 dt$	$1 \leq PW \leq 10\text{ms}$ , $T_{vj}=25^{\circ}\text{C}$	105	$\text{A}^2\text{s}$
		$1 \leq PW \leq 10\text{ms}$ , $T_{vj}=150^{\circ}\text{C}$	59	$\text{A}^2\text{s}$
Total power dissipation	$P_D$	164 *3	W	
Virtual junction temperature	$T_{vj}$	175	$^{\circ}\text{C}$	
Range of storage temperature	$T_{stg}$	-40 to +175	$^{\circ}\text{C}$	

\*1 Limited by maximum  $T_{vj}$  and for Max.  $R_{thJC}$ . \*2  $T_c=100^{\circ}\text{C}$ ,  $T_{vj}=150^{\circ}\text{C}$ , Duty cycle=10% \*3  $T_c=25^{\circ}\text{C}$

**●Electrical characteristics** ( $T_{vj}=25^{\circ}\text{C}$  unless otherwise specified)

Parameter	Symbol	Conditions	Values			Unit
			Min.	Typ.	Max.	
DC blocking voltage	$V_{DC}$	$I_R = 40\mu\text{A}$	1200	-	-	V
Forward voltage	$V_F$	$I_F = 15\text{A}$ $T_{vj} = 25^{\circ}\text{C}$	-	1.4	1.6	V
		$I_F = 15\text{A}$ $T_{vj} = 150^{\circ}\text{C}$	-	1.8	-	V
		$I_F = 15\text{A}$ $T_{vj} = 175^{\circ}\text{C}$	-	2.0	-	V
Reverse current	$I_R$	$V_R = 1200\text{V}$ , $T_{vj} = 25^{\circ}\text{C}$	-	0.15	60	$\mu\text{A}$
		$V_R = 1200\text{V}$ , $T_{vj} = 150^{\circ}\text{C}$	-	10.5	150	$\mu\text{A}$
		$V_R = 1200\text{V}$ , $T_{vj} = 175^{\circ}\text{C}$	-	30	-	$\mu\text{A}$
Total capacitance	C	$V_R = 1\text{V}$ , $f = 1\text{MHz}$	-	780	-	pF
		$V_R = 800\text{V}$ , $f = 1\text{MHz}$	-	55	-	pF
Total capacitive charge	$Q_C$	$V_R = 800\text{V}$ , $di/dt = 500\text{A}/\mu\text{s}$	-	47	-	nC
Switching time	$t_C$	$V_R = 800\text{V}$ , $di/dt = 500\text{A}/\mu\text{s}$	-	22	-	ns

**●Thermal characteristics**

Parameter	Symbol	Conditions	Values			Unit
			Min.	Typ.	Max.	
Thermal resistance	$R_{thJC}$	-	-	0.68	0.91	K/W

**●Typical Transient Thermal Characteristics**

Symbol	Value	Unit	Symbol	Value	Unit
$R_{th1}$	$3.3 \times 10^{-1}$	K/W	$C_{th1}$	$3.9 \times 10^{-3}$	Ws/K
$R_{th2}$	$2.1 \times 10^{-1}$		$C_{th2}$	$2.2 \times 10^{-2}$	
$R_{th3}$	$1.4 \times 10^{-1}$		$C_{th3}$	$1.6 \times 10^{-1}$	

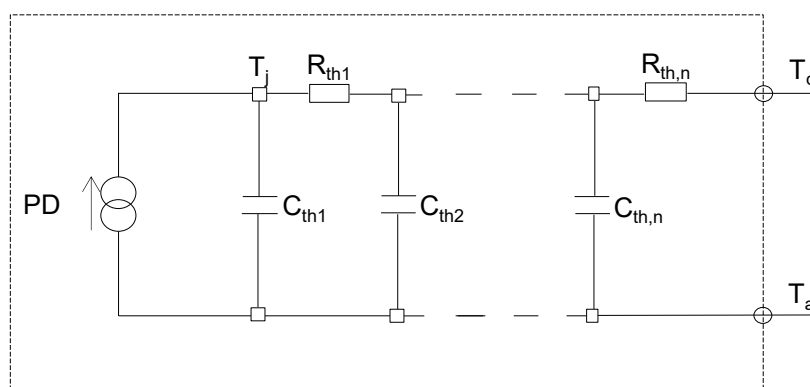

●Electrical characteristic curves

Fig.1  $V_F - I_F$  Characteristics

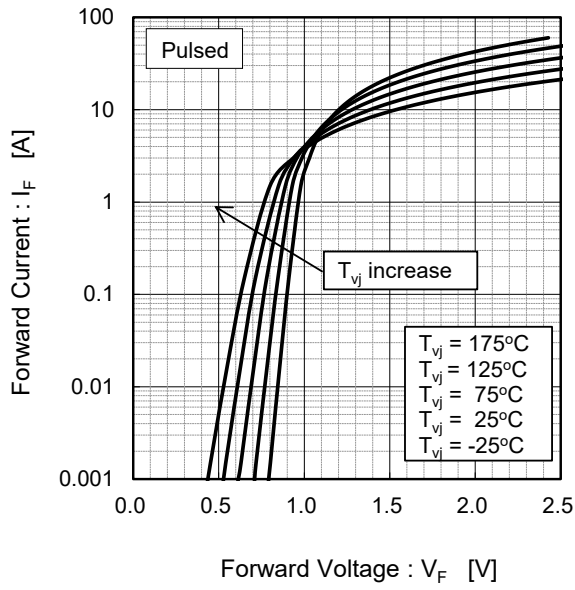

Fig.2  $V_F - I_F$  Characteristics

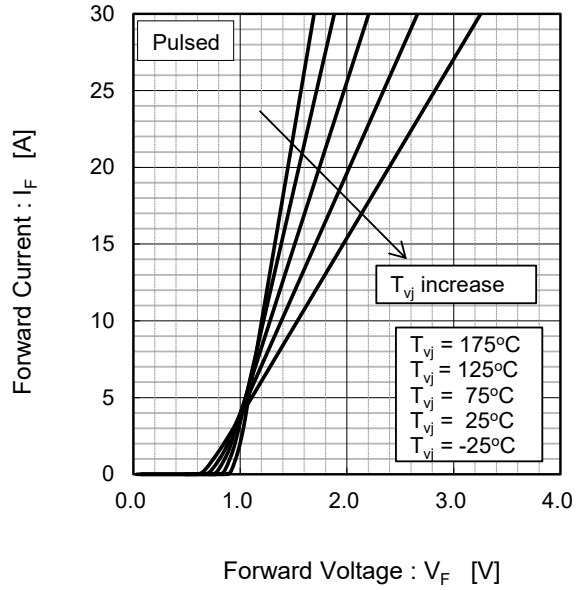

Fig.3  $V_R - I_R$  Characteristics

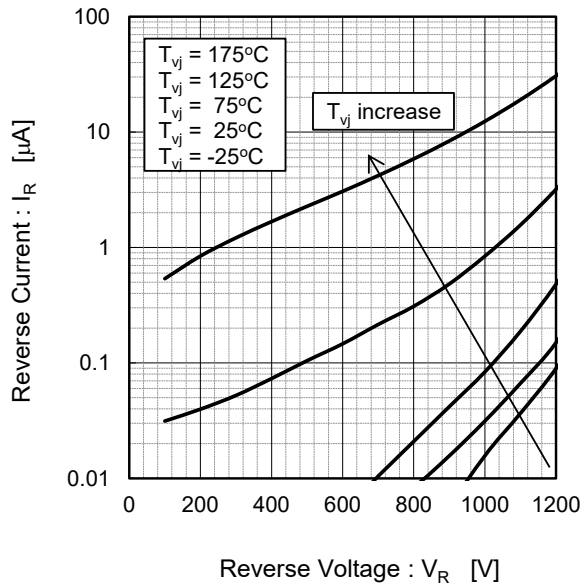
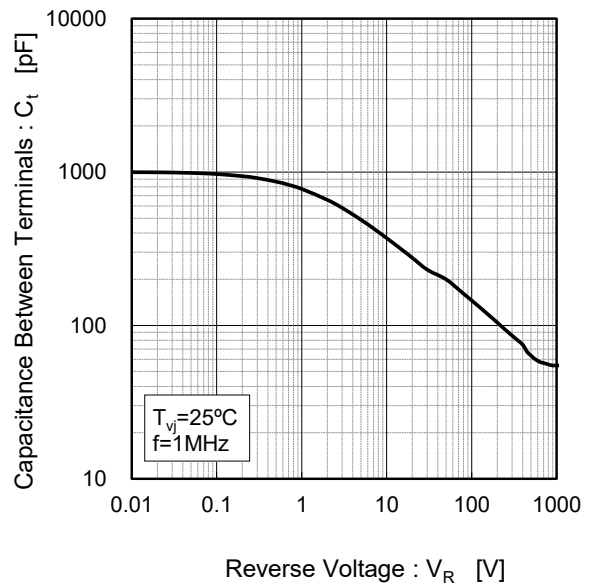

Fig.4  $V_R - C_t$  Characteristics



●Electrical characteristic curves

Fig.5 Typical Transient Thermal Resistance vs. Pulse Width

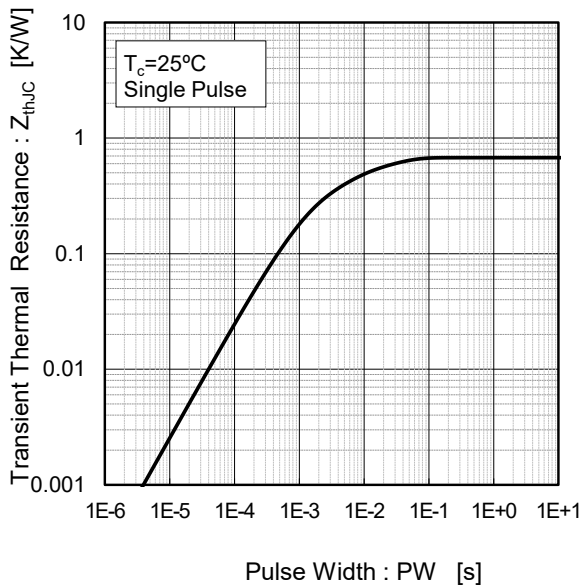

Fig.6 Power Dissipation

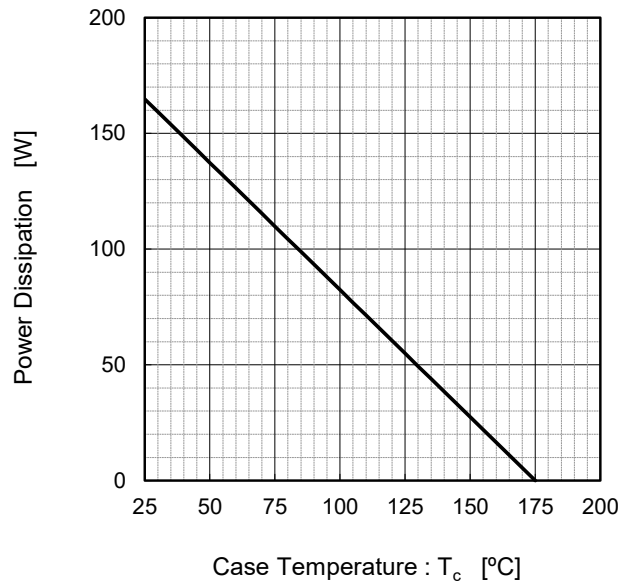
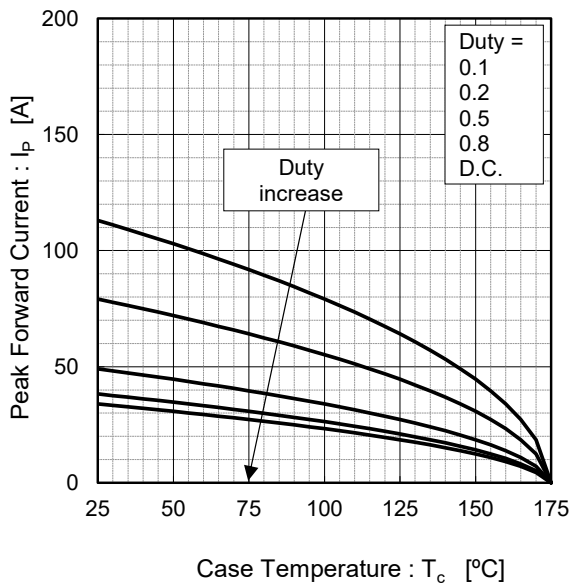
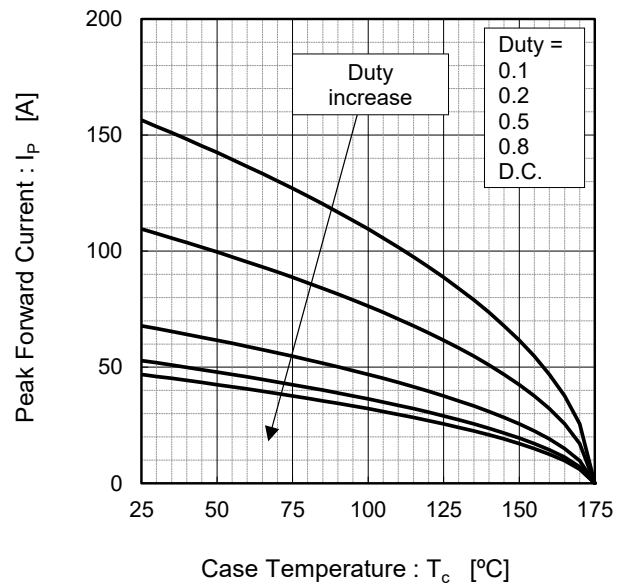

Fig.7\*4 Maximum peak forward current derating curve  $I_p - T_c$



\*4 Based on max Vf, max  $R_{thJC}$   
Valid for switching of above 10kHz,  
excluding D.C. curve.

Fig.8\*5 Typical peak forward current derating curve  $I_p - T_c$  (Not guaranteed)



\*5 Based on typ Vf, typ  $R_{thJC}$   
Typical value, not guaranteed  
Valid for switching of above 10kHz,  
excluding D.C. curve

●Electrical characteristic curves

Fig.9 Surge non-repetitive forward current vs. Pulse Width (Sinusoidal waveform)

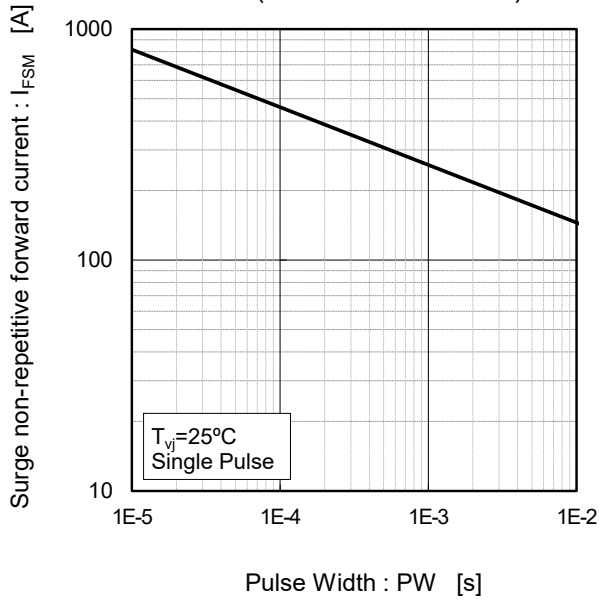
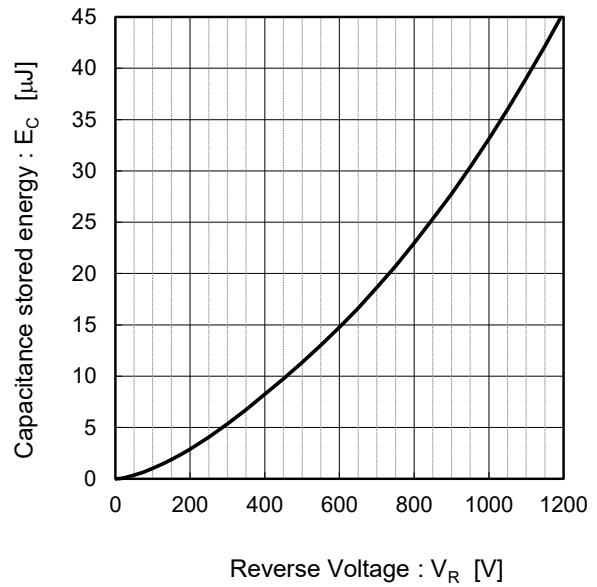
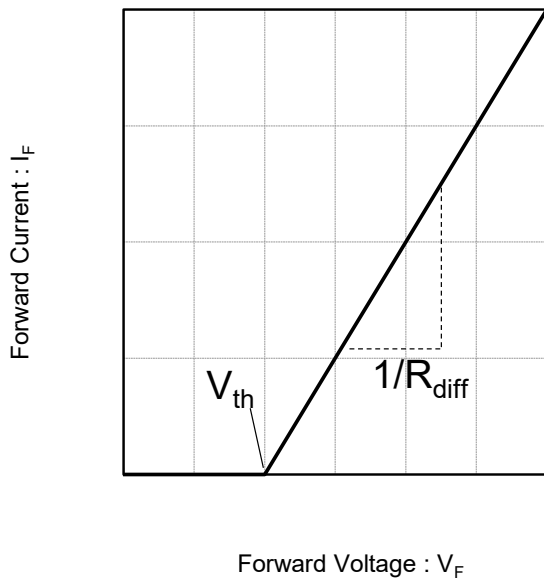

Fig.10 Typical capacitance store energy



●Simplified forward characteristic model

Fig.11 Equivalent forward current curve



$$V_F = V_{th} + R_{diff} I_F$$

$$V_{th}(T_{vj}) = a_0 + a_1 T_{vj}$$

$$R_{diff}(T_{vj}) = b_0 + b_1 T_{vj} + b_2 T_{vj}^2$$

Symbol	Typical Value	Unit
a <sub>0</sub>	0.922	V
a <sub>1</sub>	-1.388	mV/°C
b <sub>0</sub>	28.27	mΩ
b <sub>1</sub>	0.172	mΩ/°C
b <sub>2</sub>	0.894	μΩ/°C <sup>2</sup>

T<sub>vj</sub> in °C; -55 °C < T<sub>vj</sub> < 175°C ; I<sub>F</sub> < 30 A

## ●Package Dimensions

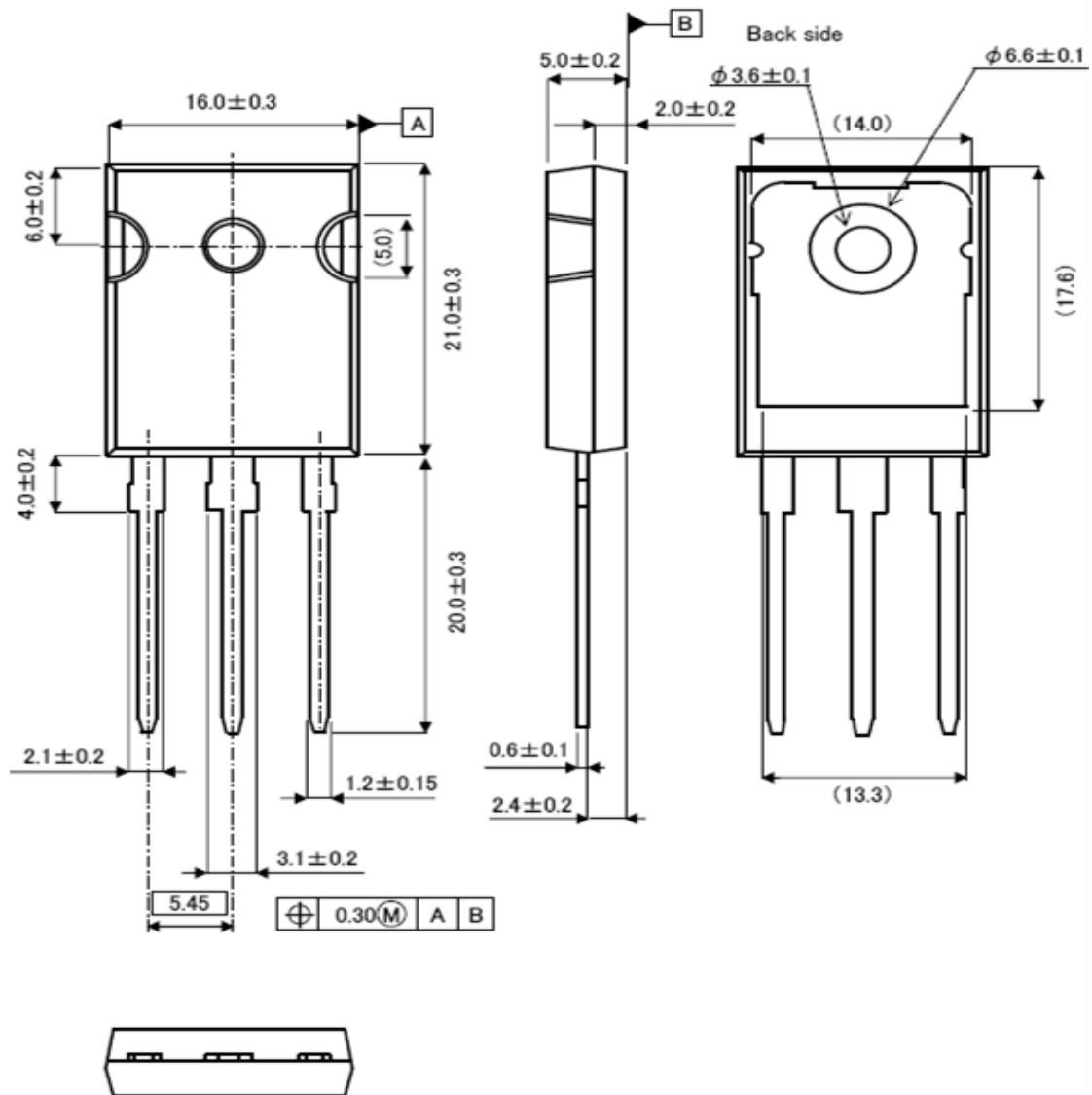

•Dimensions do not include mold flash, protrusion or gate burrs.

Unit: mm

## Notes

- 1) The information contained herein is subject to change without notice.
- 2) Before you use our Products, please contact our sales representative and verify the latest specifications.
- 3) Although ROHM is continuously working to improve product reliability and quality, semiconductors can break down and malfunction due to various factors. Therefore, in order to prevent personal injury or fire arising from failure, please take safety measures such as complying with the derating characteristics, implementing redundant and fire prevention designs, and utilizing backups and fail-safe procedures. ROHM shall have no responsibility for any damages arising out of the use of our Products beyond the rating specified by ROHM.
- 4) Examples of application circuits, circuit constants and any other information contained herein are provided only to illustrate the standard usage and operations of the Products. The peripheral conditions must be taken into account when designing circuits for mass production.
- 5) The technical information specified herein is intended only to show the typical functions of and examples of application circuits for the Products. ROHM does not grant you, explicitly or implicitly, any license to use or exercise intellectual property or other rights held by ROHM or any other parties. ROHM shall have no responsibility whatsoever for any dispute arising out of the use of such technical information.
- 6) The Products specified in this document are not designed to be radiation tolerant.
- 7) For use of our Products in applications requiring a high degree of reliability (as exemplified below), please contact and consult with a ROHM representative : transportation equipment (i.e. cars, ships, trains), primary communication equipment, traffic lights, fire/crime prevention, safety equipment, medical systems, and power transmission systems.
- 8) Do not use our Products in applications requiring extremely high reliability, such as aerospace equipment, nuclear power control systems, and submarine repeaters.
- 9) ROHM shall have no responsibility for any damages or injury arising from non-compliance with the recommended usage conditions and specifications contained herein.
- 10) ROHM has used reasonable care to ensure the accuracy of the information contained in this document. However, ROHM does not warrants that such information is error-free, and ROHM shall have no responsibility for any damages arising from any inaccuracy or misprint of such information.
- 11) Please use the Products in accordance with any applicable environmental laws and regulations, such as the RoHS Directive. For more details, including RoHS compatibility, please contact a ROHM sales office. ROHM shall have no responsibility for any damages or losses resulting non-compliance with any applicable laws or regulations.
- 12) When providing our Products and technologies contained in this document to other countries, you must abide by the procedures and provisions stipulated in all applicable export laws and regulations, including without limitation the US Export Administration Regulations and the Foreign Exchange and Foreign Trade Act.
- 13) This document, in part or in whole, may not be reprinted or reproduced without prior consent of ROHM.



Thank you for your accessing to ROHM product informations.  
More detail product informations and catalogs are available, please contact us.

## ROHM Customer Support System

<http://www.rohm.com/contact/>

**General Precaution**

1. Before you use our Products, you are requested to carefully read this document and fully understand its contents. ROHM shall not be in any way responsible or liable for failure, malfunction or accident arising from the use of any ROHM's Products against warning, caution or note contained in this document.
2. All information contained in this document is current as of the issuing date and subject to change without any prior notice. Before purchasing or using ROHM's Products, please confirm the latest information with a ROHM sales representative.
3. The information contained in this document is provided on an "as is" basis and ROHM does not warrant that all information contained in this document is accurate and/or error-free. ROHM shall not be in any way responsible or liable for any damages, expenses or losses incurred by you or third parties resulting from inaccuracy or errors of or concerning such information.