

Serial EEPROM Series for Standard EEPROM

WLCSP EEPROM

BRCD008GWZ-5

General Description

BRCD008GWZ-5 is a 8 Kbit serial EEPROM of I²C BUS Interface.

Features

- All Controls Available by 2 Ports of Serial Clock (SCL) and Serial Data (SDA)
- 1.7 V to 3.6 V of Operating Voltage, Possible 400 kHz Operation
- Page Write Mode 16 Byte
- Bit Format 1 K x 8 bit
- Low Current Consumption
- Data Retention 100 Years (Ta = 25 °C)
- Power-on Reset Circuit
- Prevention of Miswriting at Low Voltage
- Noise Filter and Schmitt Trigger Circuit Built in SCL/SDA Pin for Noises Reduction
- Initial Delivery State FFh

Key Specifications

- Write Cycles: 1 Million Times (Ta = 25 °C)
- Data Retention: 100 Years (Ta = 25 °C)
- Write Cycle Time: 5 ms (Max)
- Supply Voltage: 1.7 V to 3.6 V
- Ambient Operating Temperature: -40 °C to +85 °C

Package

Package	W (Typ) x D (Typ) x H (Max)
UCSP30L1 (4Pin)	0.70 mm x 0.70 mm x 0.33 mm

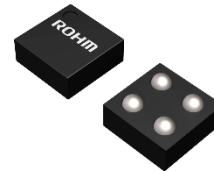

Figure 2

Applications

- Ordinary Electronic Equipment

Typical Application Circuit

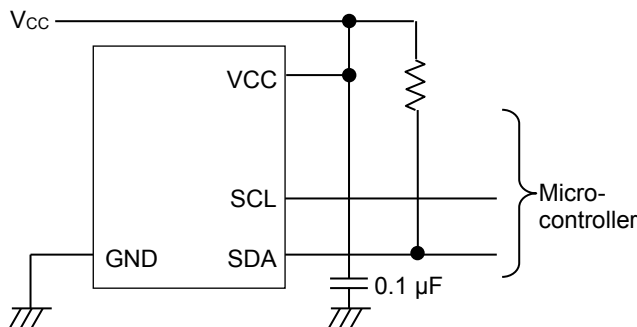

Figure 1. Typical Application Circuit

Contents

General Description	1
Features.....	1
Applications	1
Typical Application Circuit	1
Key Specifications	1
Package.....	1
Contents	2
Pin Configuration	3
Pin Description.....	3
Block Diagram	3
Absolute Maximum Ratings	4
Operating Conditions	5
Input/Output Capacitance	5
Memory Cell Characteristics	5
Electrical Characteristics.....	5
AC Characteristics	6
AC Characteristics Condition	6
Input/Output Timing	7
Typical Performance Curves.....	8
I ² C BUS Communication.....	16
Write Command	17
Read Command.....	18
Method of Reset	19
Acknowledge Polling.....	19
Command Cancel by Start Condition and Stop Condition	20
Application Examples	21
Caution on Power-Up Conditions.....	23
I/O Equivalence Circuits.....	24
Operational Notes.....	25
Ordering Information	27
Marking Diagram	28
Physical Dimension and Packing Information	29
Revision History.....	30

Pin Configuration

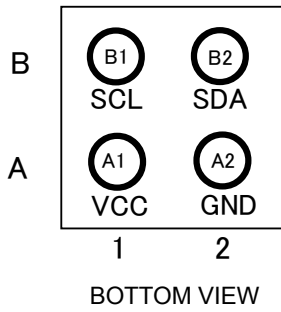

Figure 3. Pin Configuration (UCSP30L1)

Pin Description

Land No.	Pin Name	Input/Output	Descriptions
B2	SDA	Input/Output	Serial data input / serial data output ^(Note 1)
B1	SCL	Input	Serial clock input
A2	GND	-	Reference voltage of all input/output, 0 V
A1	VCC	-	Connect to the power source

(Note 1) SDA is NMOS open drain, so it requires a pull-up resistor.

Block Diagram

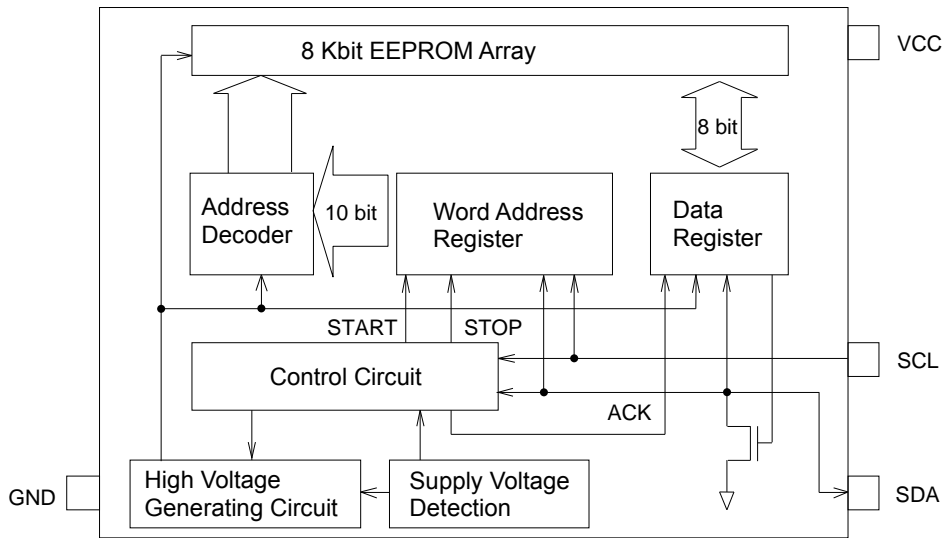

Figure 4. Block Diagram

Absolute Maximum Ratings

Parameter	Symbol	Rating	Unit	Remark
Supply Voltage	V _{CC}	-0.3 to +4.5	V	Ta = 25 °C
Input Voltage / Output Voltage	-	-0.3 to V _{CC} +1.0	V	Ta = 25 °C. The maximum value of input voltage / output voltage is not over than 4.5 V. When the pulse width is 50 ns or less, the minimum value of input voltage / output voltage is -1.0 V.
Electro Static Discharge (Human Body Model)	V _{ESD}	-2000 to +2000	V	Ta = 25 °C
Maximum Output Low Current (SDA)	I _{OLMAX}	10	mA	Ta = 25 °C
Maximum Junction Temperature	T _{jmax}	150	°C	-
Storage Temperature Range	T _{stg}	-65 to +150	°C	-

Caution 1: Operating the IC over the absolute maximum ratings may damage the IC. The damage can either be a short circuit between pins or an open circuit between pins and the internal circuitry. Therefore, it is important to consider circuit protection measures, such as adding a fuse, in case the IC is operated over the absolute maximum ratings.

Caution 2: Should by any chance the maximum junction temperature rating be exceeded the rise in temperature of the chip may result in deterioration of the properties of the chip. In case of exceeding this absolute maximum rating, design a PCB with thermal resistance taken into consideration by increasing board size and copper area so as not to exceed the maximum junction temperature rating.

Operating Conditions

Parameter	Symbol	Min	Typ	Max	Unit
Supply Voltage	V _{CC}	1.7	-	3.6	V
Ambient Operating Temperature	T _a	-40	-	+85	°C
Bypass Capacitor ^(Note 2)	C	0.1	-	-	μF

(Note 2) Connect a bypass capacitor between the IC's V_{CC} and GND pins.

Input/Output Capacitance (T_a = 25 °C, f = 400 kHz)

Parameter	Symbol	Min	Typ	Max	Unit	Conditions
Input/Output Capacitance (SDA) ^(Note 3)	C _{I/O}	-	-	8	pF	V _{I/O} = GND
Input Capacitance (SCL) ^(Note 3)	C _{IN}	-	-	8	pF	V _{IN} = GND

(Note 3) Not 100 % Tested.

Memory Cell Characteristics (V_{CC} = 1.7 V to 3.6 V)

Parameter	Symbol	Min	Typ	Max	Unit	Conditions
Write Cycles ^(Note 4)	-	1,000,000	-	-	Times	T _a = 25 °C
Data Retention ^(Note 4)	-	100	-	-	Years	T _a = 25 °C

(Note 4) Not 100 % Tested.

Electrical Characteristics (Unless otherwise specified, T_a = -40 °C to +85 °C, V_{CC} = 1.7 V to 3.6 V)

Parameter	Symbol	Min	Typ	Max	Unit	Conditions
Input High Voltage	V _{IH}	0.7V _{CC}	-	V _{CC} +1.0	V	-
Input Low Voltage	V _{IL}	-0.3 ^(Note 5)	-	+0.3V _{CC}	V	-
Input Hysteresis	V _{HYST}	0.1	-	-	V	-
Output Low Voltage1	V _{OL1}	-	-	0.4	V	I _{OL} = 3.0 mA, 2.5 V ≤ V _{CC} ≤ 3.6 V
Output Low Voltage2	V _{OL2}	-	-	0.2	V	I _{OL} = 1.0 mA, 1.7 V ≤ V _{CC} < 2.5 V
Input Leakage Current	I _{LI}	-1	-	+1	μA	V _{IN} = 0 V to V _{CC} (SCL)
Output Leakage Current	I _{LO}	-1	-	+1	μA	V _{OUT} = 0 V to V _{CC} (SDA)
Supply Current (Write) ^(Note 6)	I _{CC1}	-	-	2.0	mA	V _{CC} = 3.6 V, f _{SCL} = 400 kHz, t _{WR} = 5 ms Byte Write, Page Write
Supply Current (Read) ^(Note 6)	I _{CC2}	-	-	0.5	mA	V _{CC} = 3.6 V, f _{SCL} = 400 kHz Random Read, Current Read, Sequential Read
Standby Current	I _{SB}	-	-	2.0	μA	V _{CC} = 3.6 V, SDA, SCL = V _{CC}

(Note 5) When the pulse width is 50 ns or less, it is -1.0 V.

(Note 6) The average value during operation.

AC Characteristics (Unless otherwise specified, Ta = -40 °C to +85 °C, V_{CC} = 1.7 V to 3.6 V)

Parameter	Symbol	Min	Typ	Max	Unit
Clock Frequency	f _{SCL}	-	-	400	kHz
Data Clock High Period	t _{HIGH}	0.6	-	-	μs
Data Clock Low Period	t _{LOW}	1.2	-	-	μs
SDA, SCL (input) Rise Time ^(Note 7)	t _R	-	-	0.3	μs
SDA, SCL (input) Fall Time ^(Note 7)	t _{F1}	-	-	0.3	μs
SDA (output) Fall Time ^(Note 7)	t _{F2}	-	-	0.3	μs
Start Condition Hold Time	t _{HD:STA}	0.6	-	-	μs
Start Condition Setup Time	t _{SU:STA}	0.6	-	-	μs
Input Data Hold Time	t _{HD:DAT}	0	-	-	ns
Input Data Setup Time	t _{SU:DAT}	100	-	-	ns
Output Data Delay Time	t _{PD}	0.1	-	0.9	μs
Output Data Hold Time	t _{DH}	0.1	-	-	μs
Stop Condition Setup Time	t _{SU:STO}	0.6	-	-	μs
Bus Free Time	t _{BUF}	1.2	-	-	μs
Write Cycle Time	t _{WR}	-	-	5	ms
Noise Suppression Time (SCL, SDA)	t _i	-	-	0.1	μs

(Note 7) Not 100 % Tested.

AC Characteristics Condition

Parameter	Symbol	Conditions	Unit
Load Capacitance	C _L	100	pF
Input Rise Time	t _R	20	ns
Input Fall Time	t _{F1}	20	ns
Input Voltage	V _{IH}	0.8V _{CC}	V
	V _{IL}	0.2V _{CC}	V
Input/Output Data Timing Reference Level	-	0.3V _{CC} /0.7V _{CC}	V

Input/Output Timing

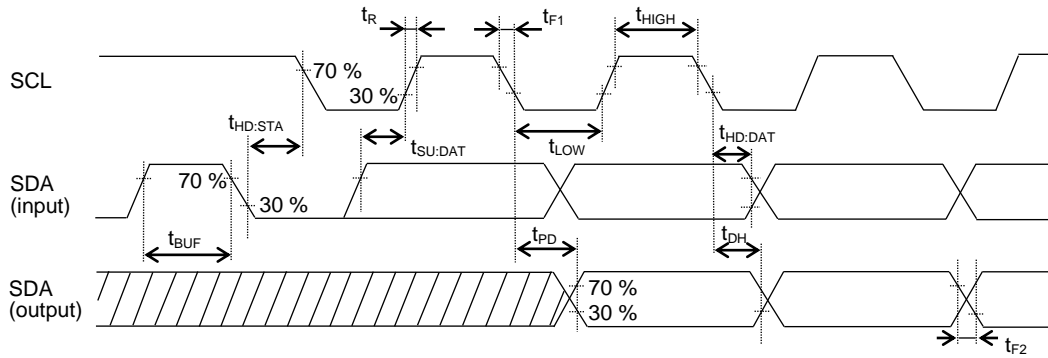

- Input read at the rise edge of SCL
- Data output in sync with the fall of SCL

Figure 5-(a). Input/Output Timing

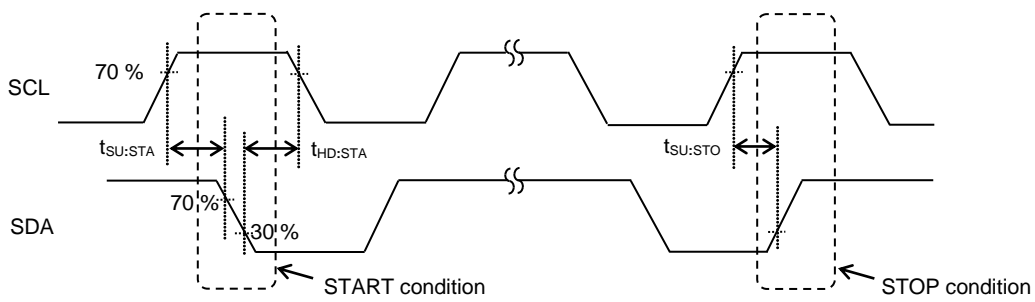

Figure 5-(b). Start-Stop Condition Timing

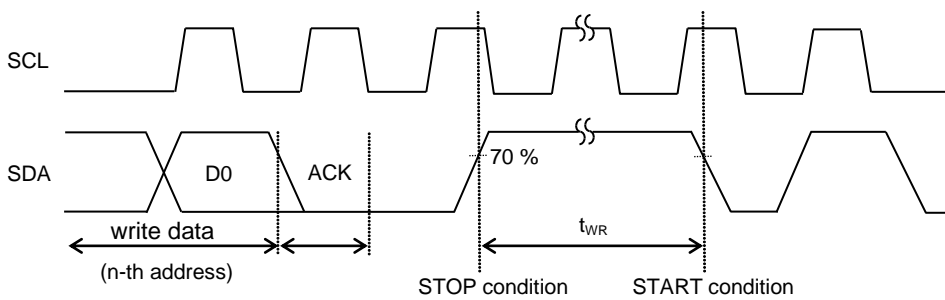

Figure 5-(c). Write Cycle Timing

Typical Performance Curves

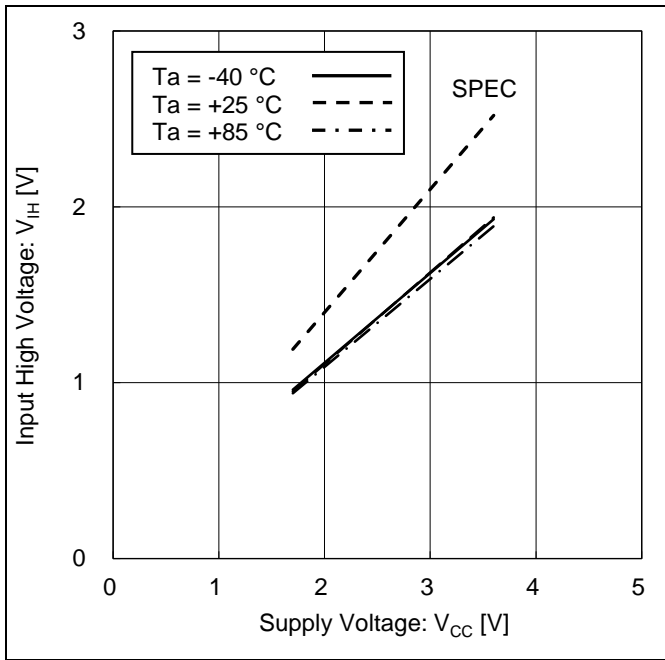

Figure 6. Input High Voltage vs Supply Voltage

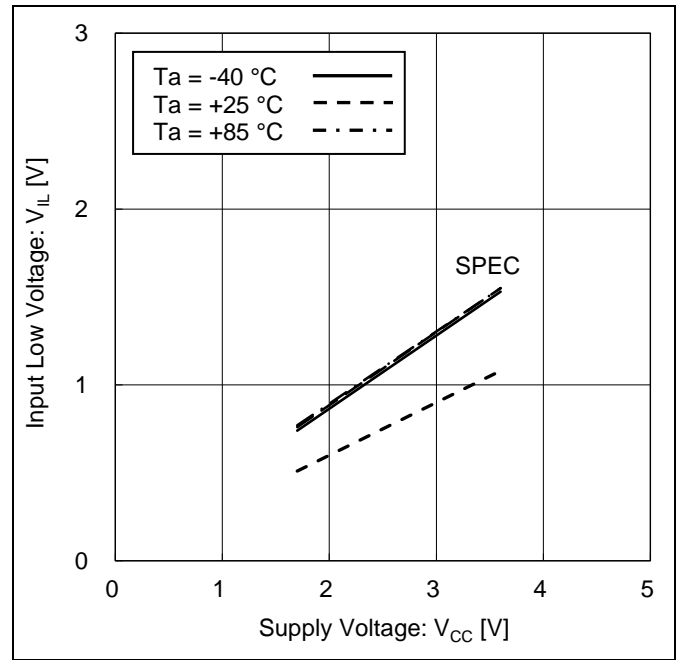

Figure 7. Input Low Voltage vs Supply Voltage

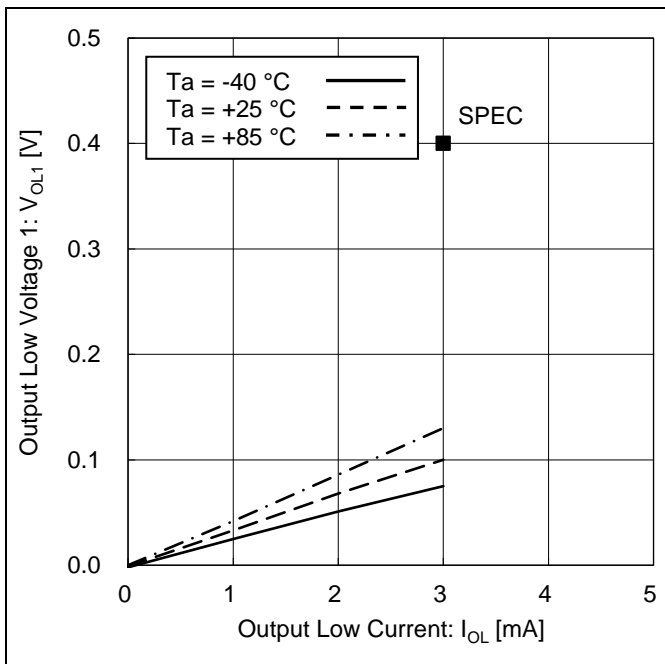

Figure 8. Output Low Voltage 1 vs Output Low Current
($V_{CC} = 2.5\text{ V}$)

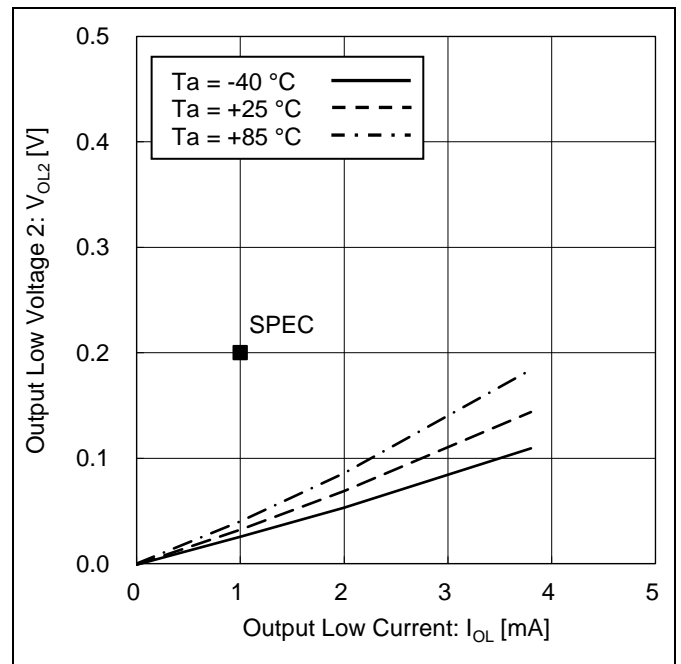

Figure 9. Output Low Voltage 2 vs Output Low Current
($V_{CC} = 1.7\text{ V}$)

Typical Performance Curves - continued

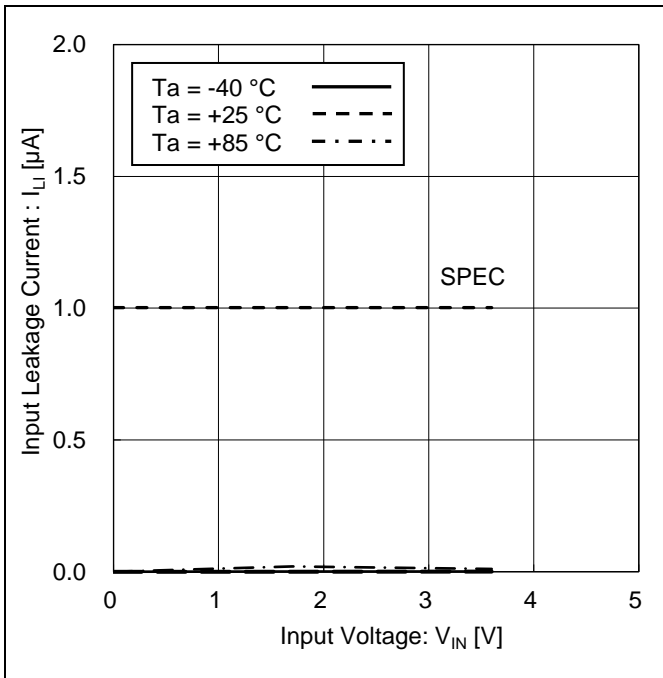

Figure 10. Input Leakage Current vs Input Voltage

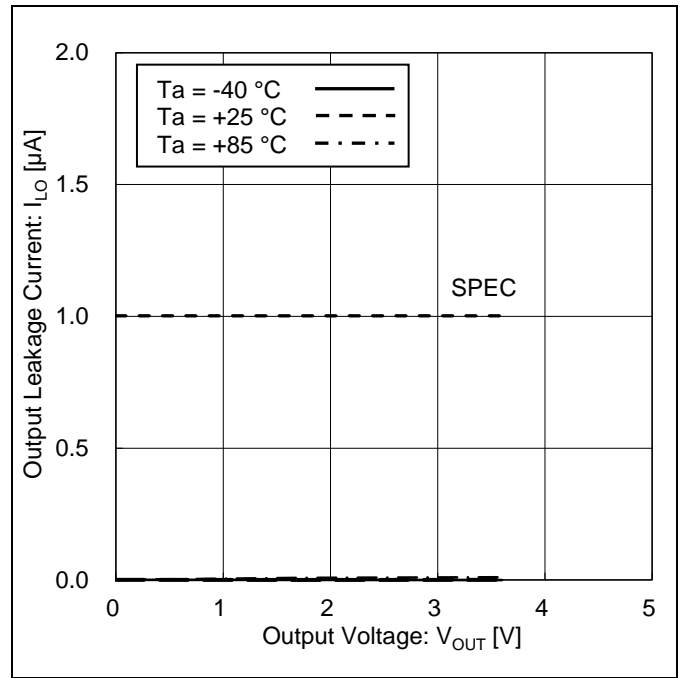

Figure 11. Output Leakage Current vs Output Voltage

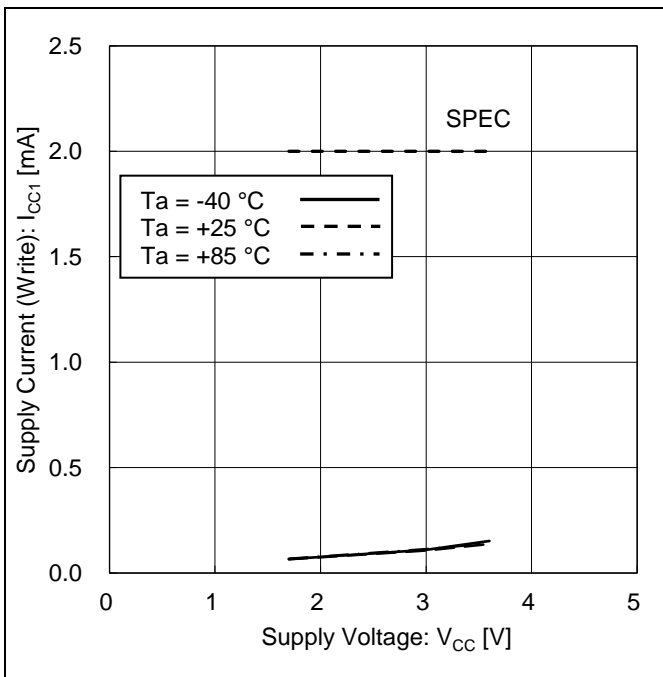

Figure 12. Supply Current (Write) vs Supply Voltage
(f_{SCL} = 400 kHz)

Typical Performance Curves - continued

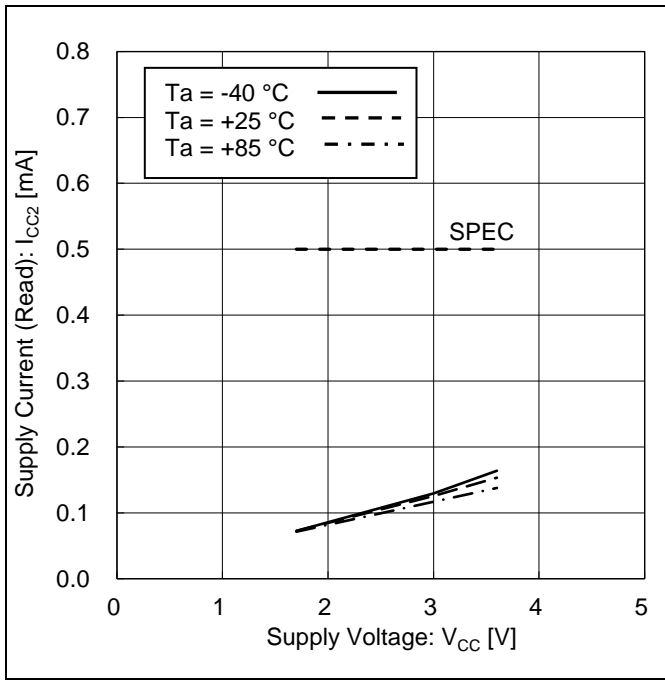

Figure 13. Supply Current (Read) vs Supply Voltage (f_{SCL} = 400 kHz)

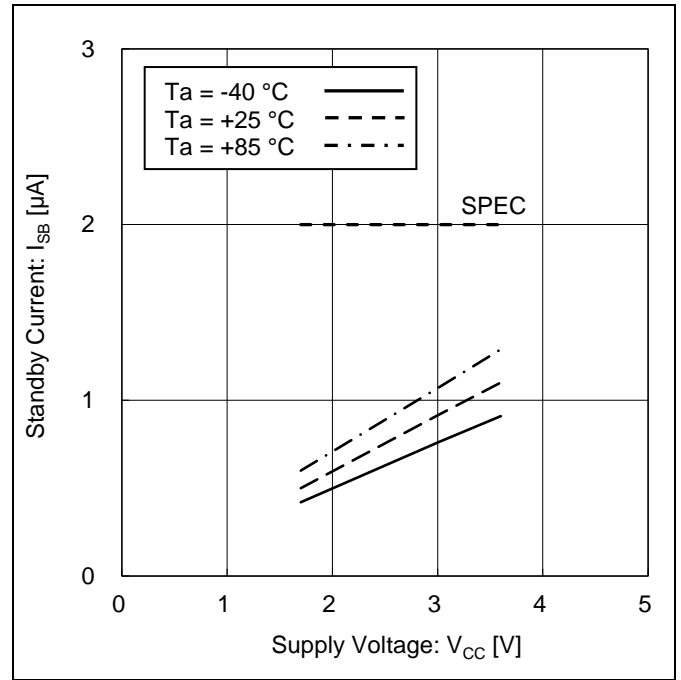

Figure 14. Standby Current vs Supply Voltage

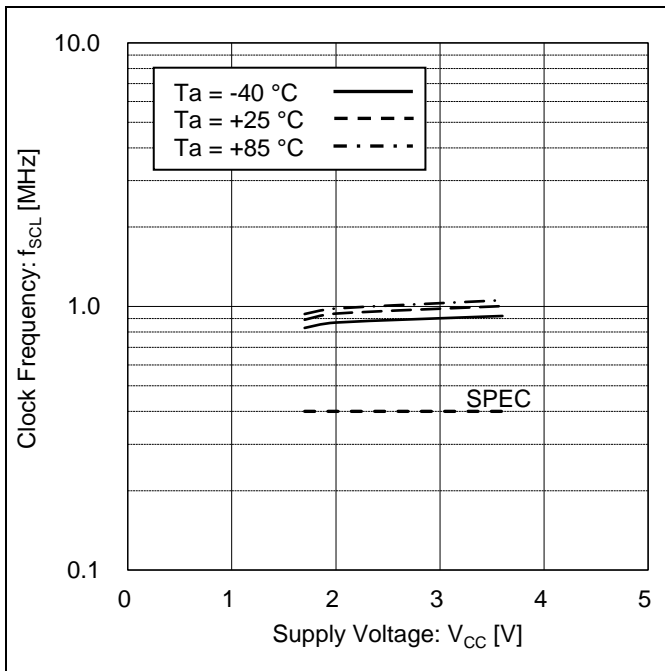

Figure 15. Clock Frequency vs Supply Voltage

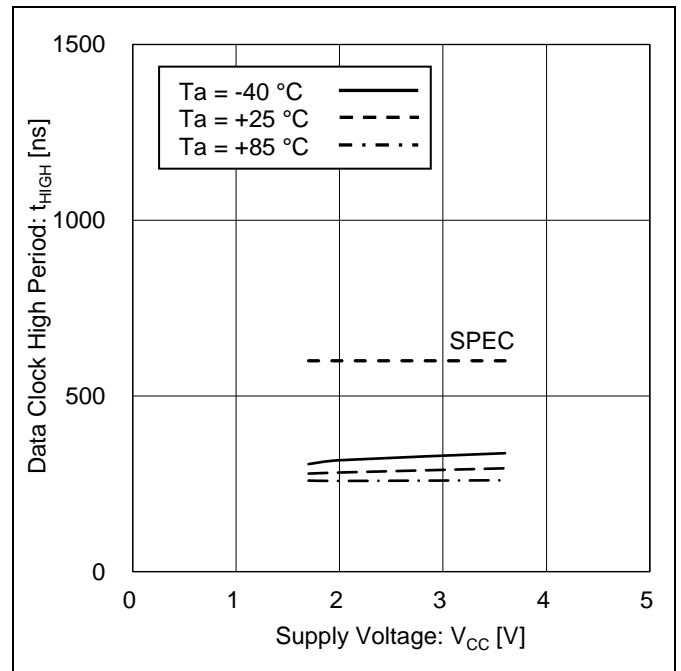

Figure 16. Data Clock High Period vs Supply Voltage

Typical Performance Curves - continued

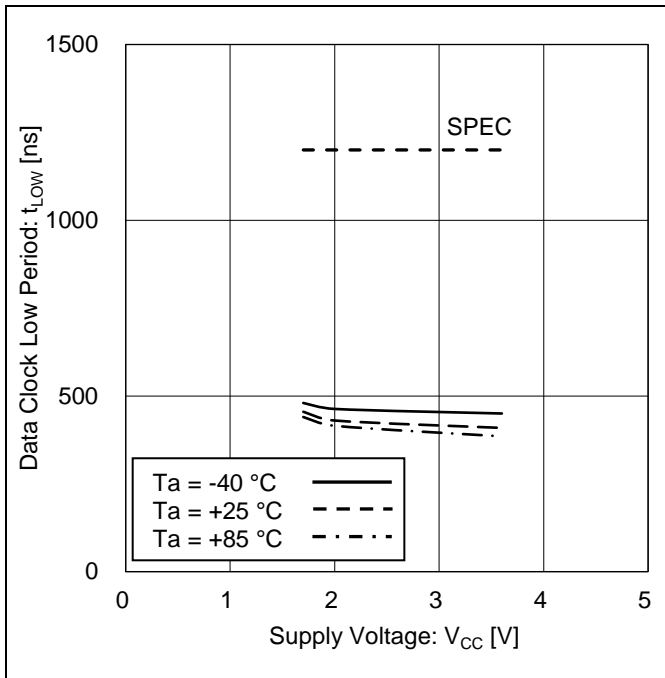

Figure 17. Data Clock Low Period vs Supply Voltage

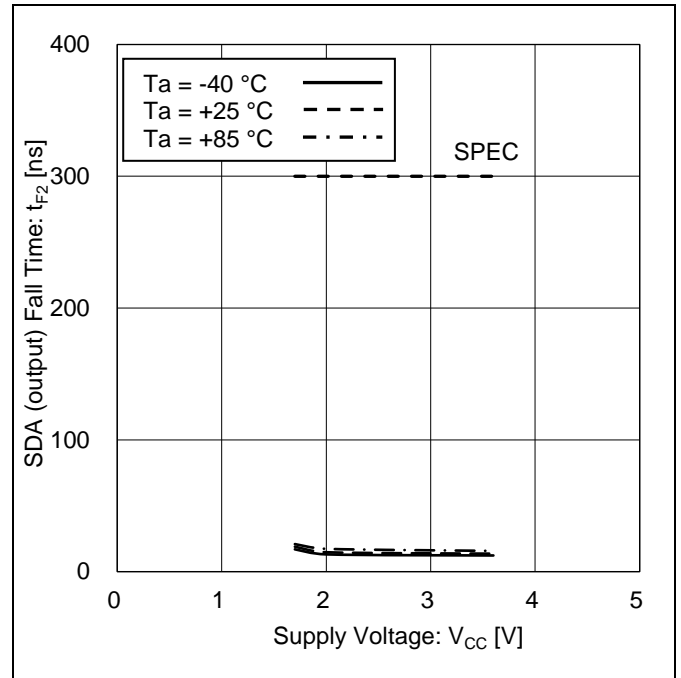

Figure 18. SDA (output) Fall Time vs Supply Voltage

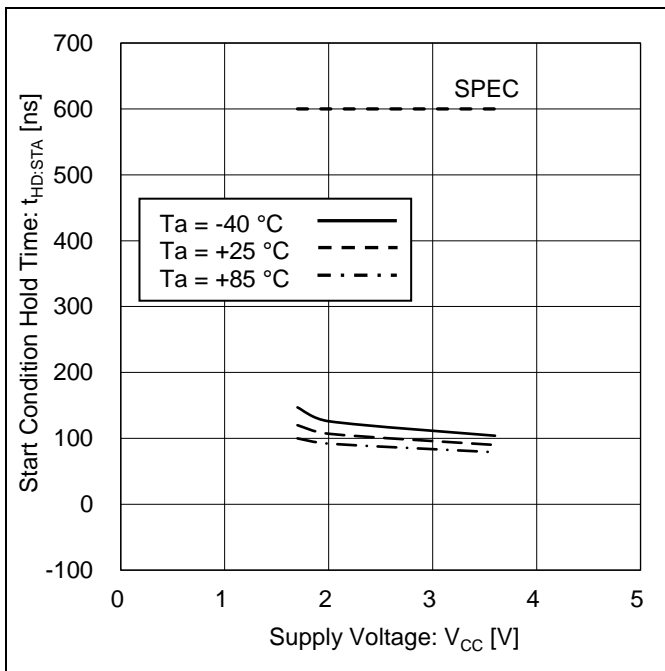

Figure 19. Start Condition Hold Time vs Supply Voltage

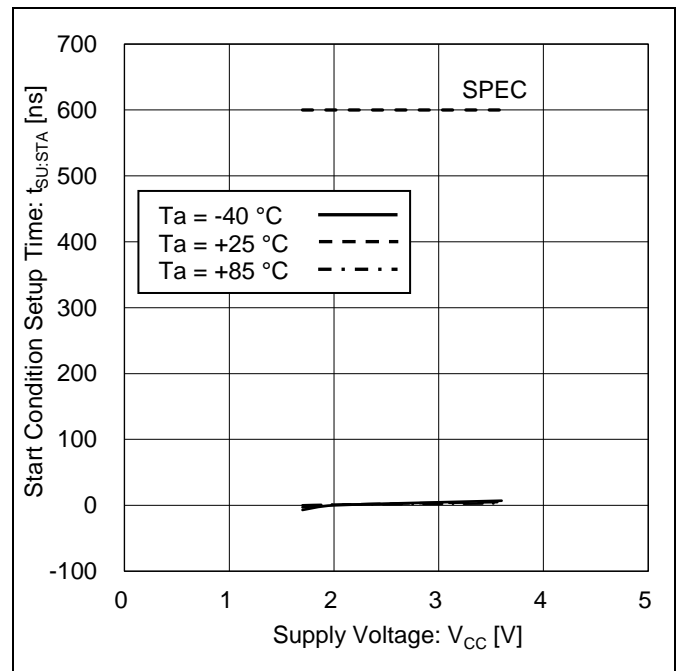

Figure 20. Start Condition Setup Time vs Supply Voltage

Typical Performance Curves - continued

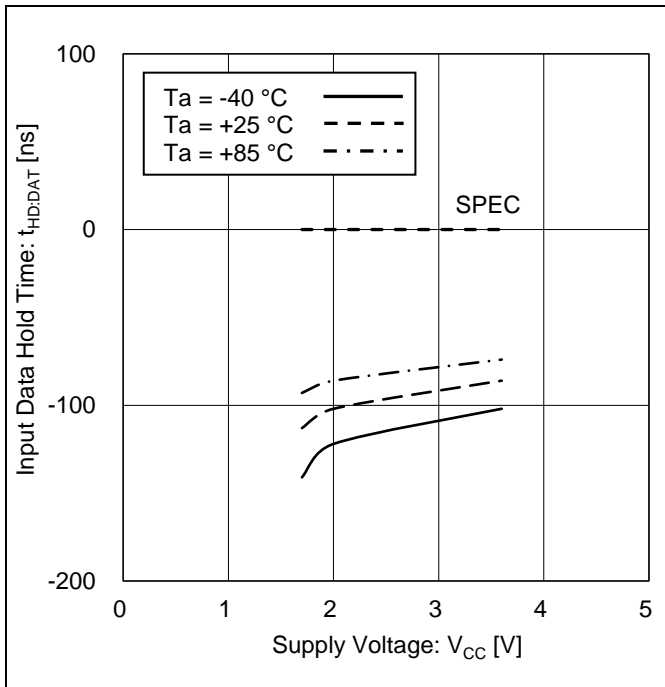

Figure 21. Input Data Hold Time vs Supply Voltage (SDA 'LOW' to 'HIGH')

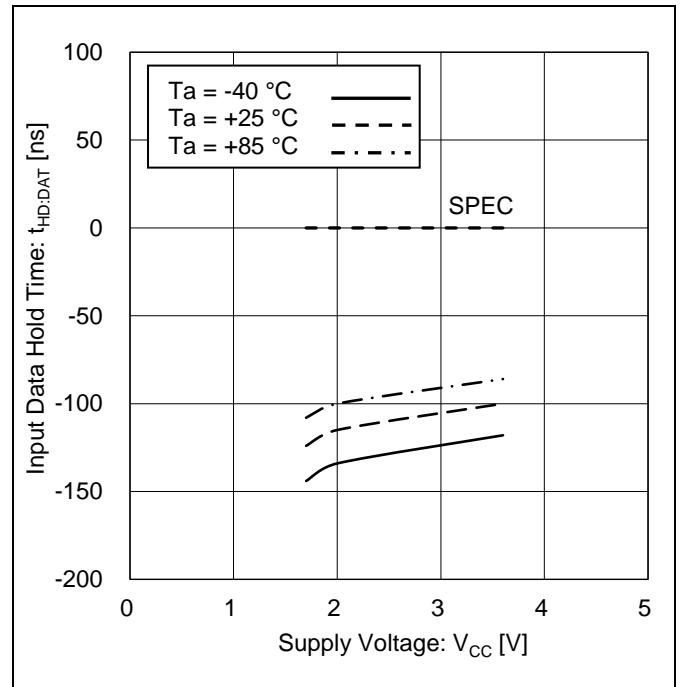

Figure 22. Input Data Hold Time vs Supply Voltage (SDA 'HIGH' to 'LOW')

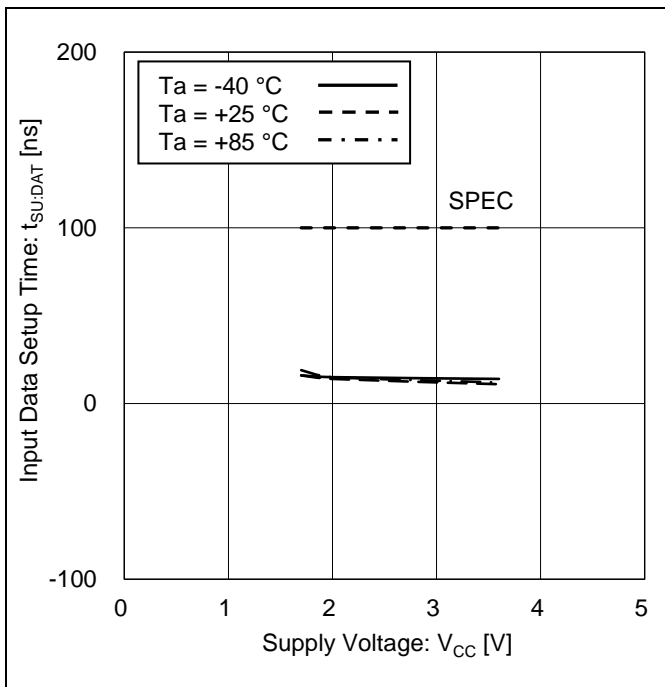

Figure 23. Input Data Setup Time vs Supply Voltage (SDA 'LOW' to 'HIGH')

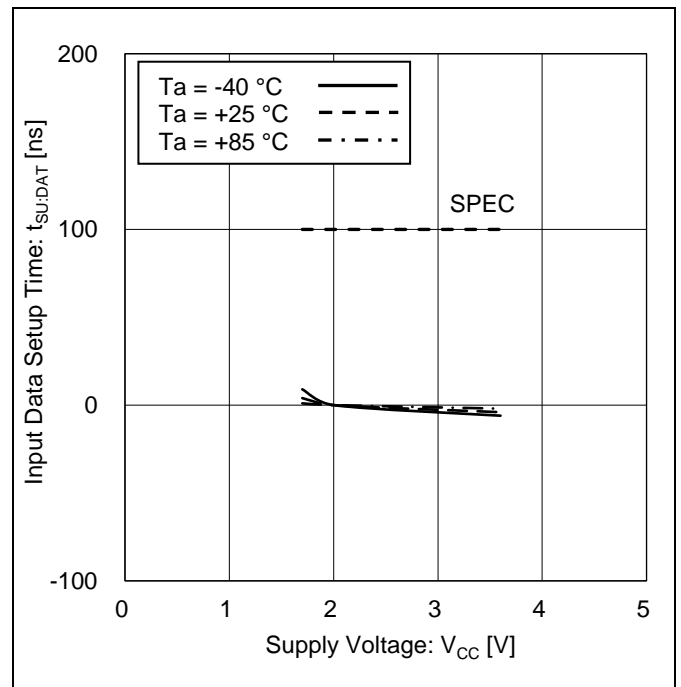

Figure 24. Input Data Setup Time vs Supply Voltage (SDA 'HIGH' to 'LOW')

Typical Performance Curves - continued

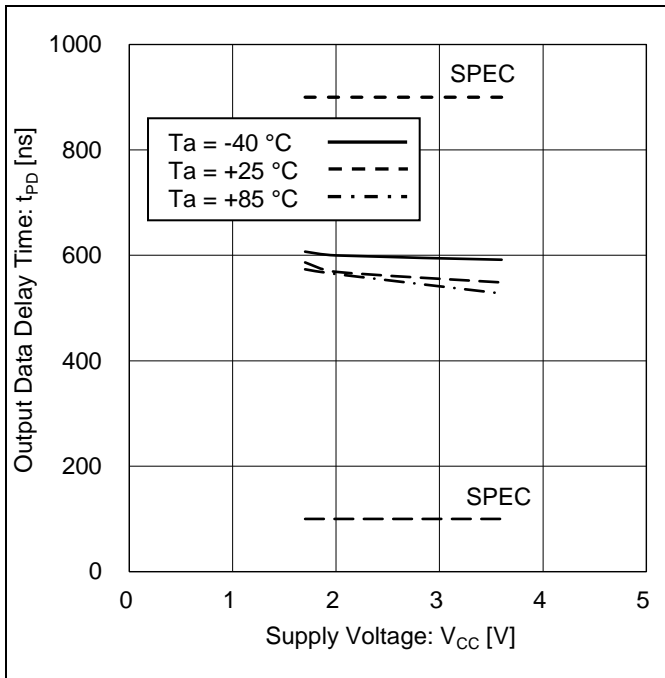

Figure 25. Output Data Delay Time vs Supply Voltage (SDA 'LOW' to 'HIGH')

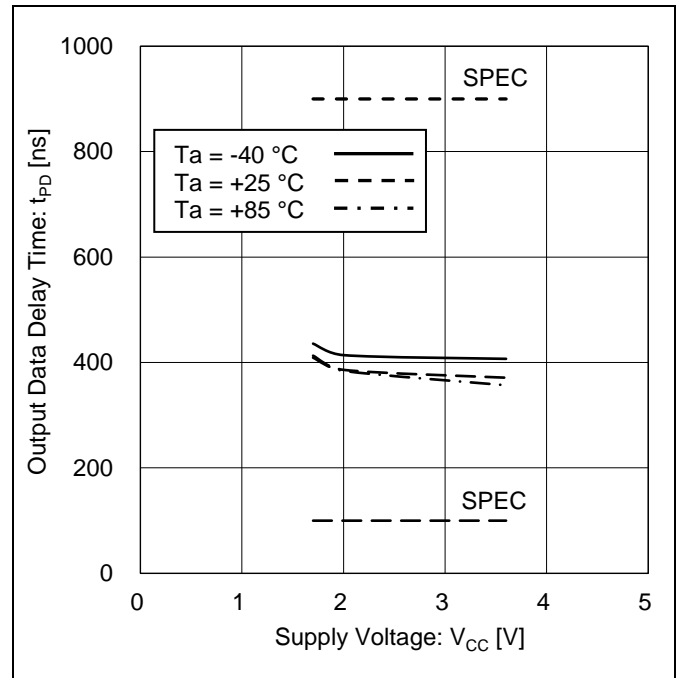

Figure 26. Output Data Delay Time vs Supply Voltage (SDA 'HIGH' to 'LOW')

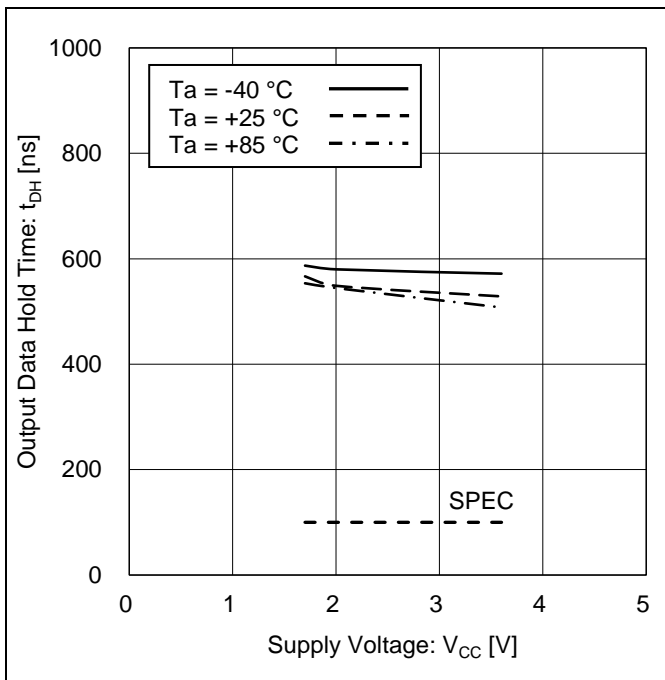

Figure 27. Output Data Hold Time vs Supply Voltage (SDA 'LOW' to 'HIGH')

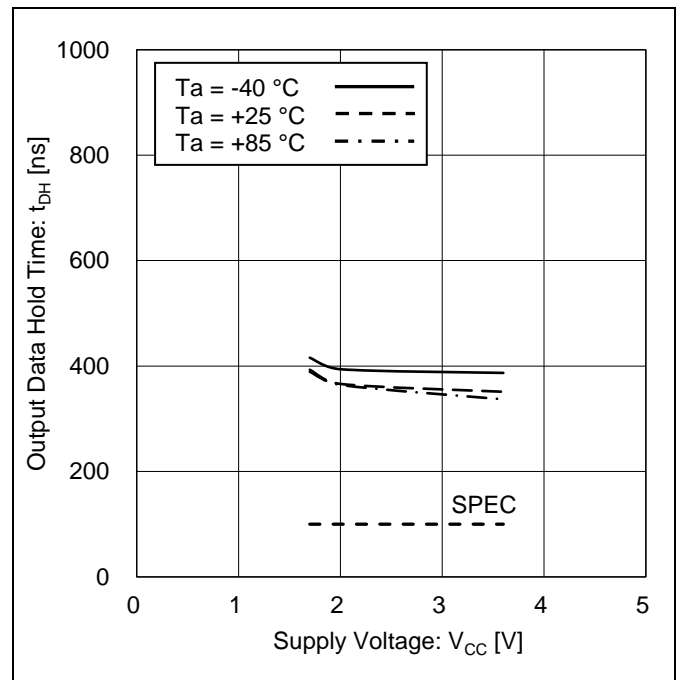

Figure 28. Output Data Hold Time vs Supply Voltage (SDA 'HIGH' to 'LOW')

Typical Performance Curves - continued

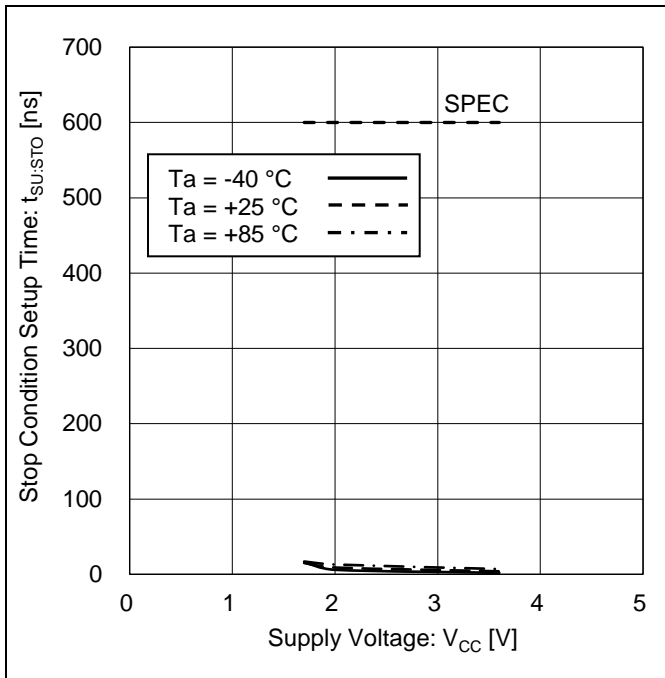

Figure 29. Stop Condition Setup Time vs Supply Voltage

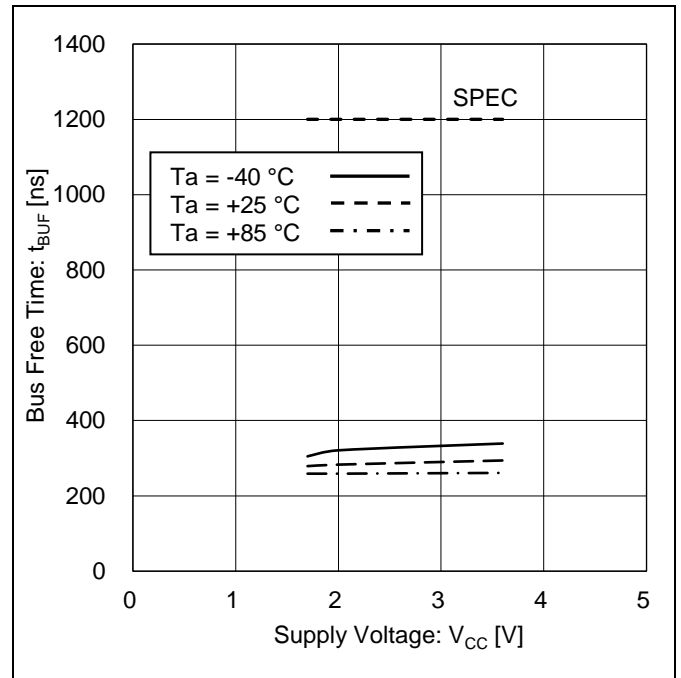

Figure 30. Bus Free Time vs Supply Voltage

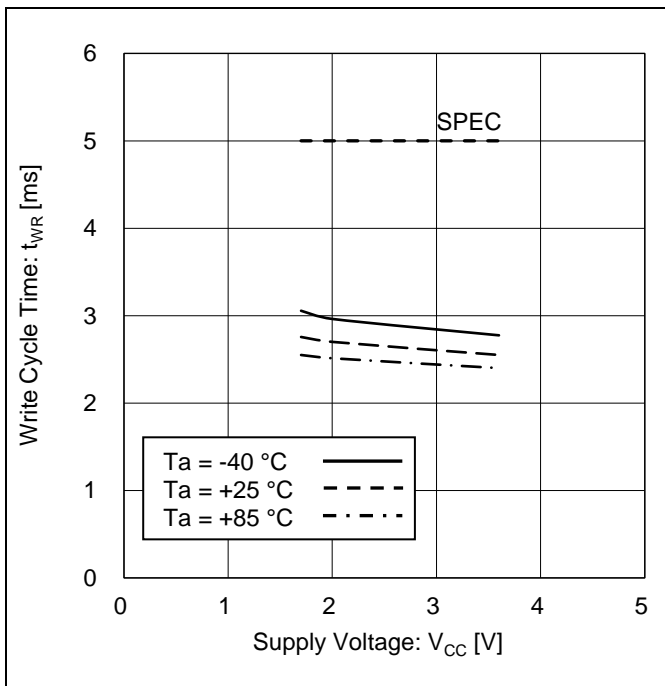

Figure 31. Write Cycle Time vs Supply Voltage

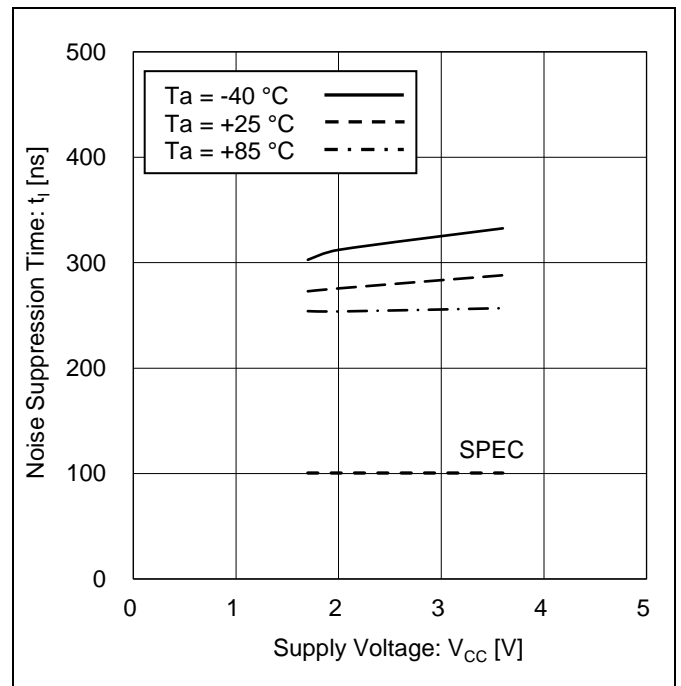

Figure 32. Noise Suppression Time vs Supply Voltage (SCL 'HIGH')

Typical Performance Curves - continued

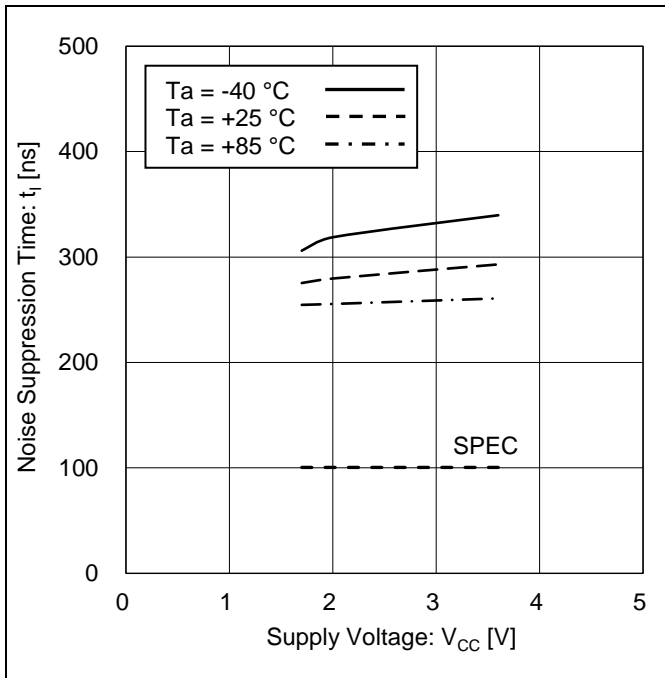

Figure 33. Noise Suppression Time vs Supply Voltage (SCL 'LOW')

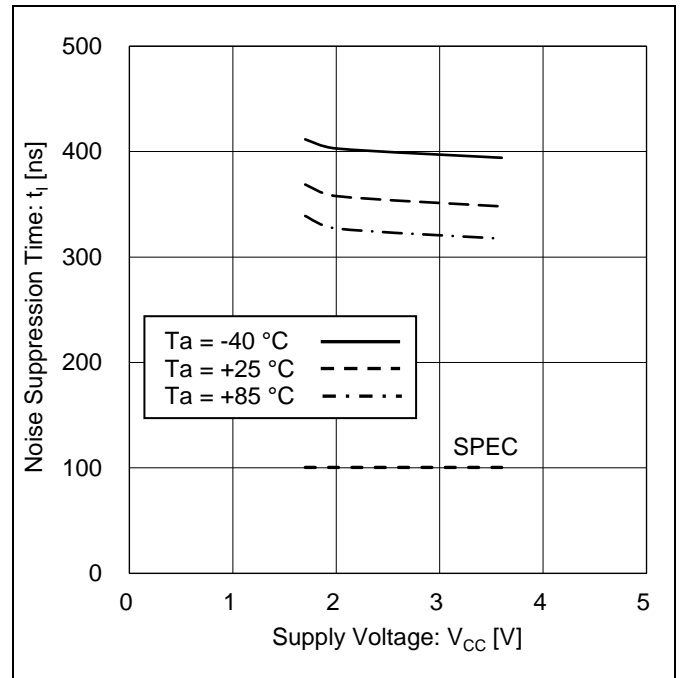

Figure 34. Noise Suppression Time vs Supply Voltage (SDA 'HIGH')

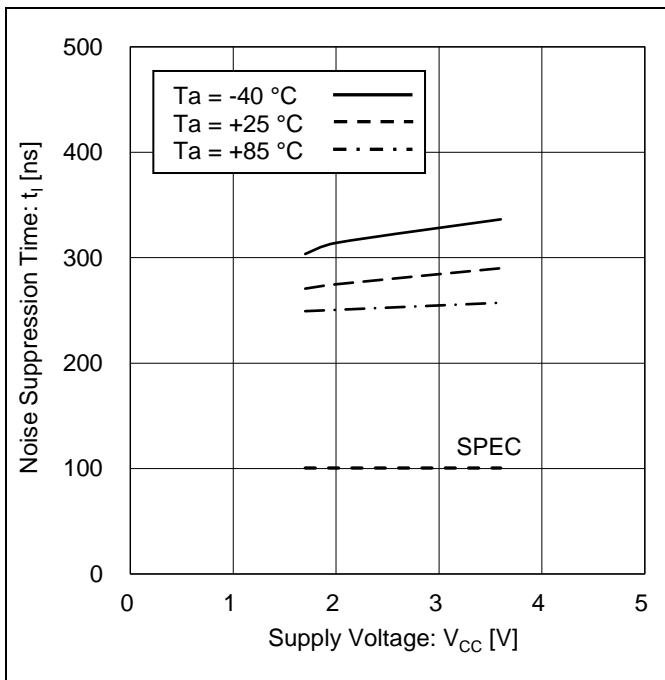

Figure 35. Noise Suppression Time vs Supply Voltage (SDA 'LOW')

I²C BUS Communication

1. I²C BUS Data Communication

- (1) I²C BUS data communication begins with start condition input, and ends at the stop condition input.
- (2) The data is always 8 bit long, and acknowledge is always required after each byte.
- (3) I²C BUS data communication with several devices connected to the BUS is possible by connecting with 2 communication lines: serial data (SDA) and serial clock (SCL).
- (4) Among the devices, there is a “controller” that generates clock and controls communication start and end. The rest is “target” which are controlled by an address peculiar to each device. EEPROM is a “target”.
- (5) The device that outputs data to the bus during data communication is called the “transmitter”, and the device that receives data is called the “receiver”.

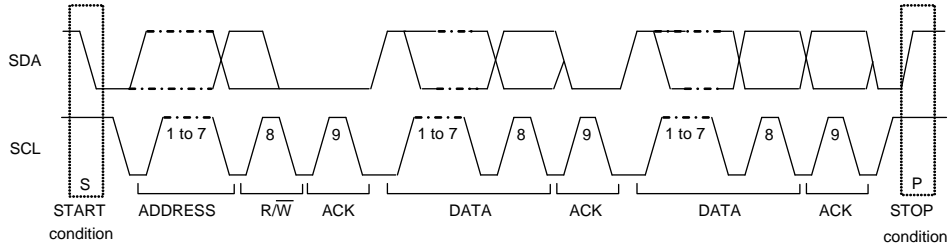

Figure 36. Data Transfer Timing

2. Start Condition (Start Bit Recognition)

- (1) Before executing each command, start condition (start bit) that SDA goes down from ‘HIGH’ to ‘LOW’ while SCL is ‘HIGH’ is necessary.
- (2) This IC always detects whether SDA and SCL are in start condition (start bit) or not, therefore, unless this condition is satisfied, any command cannot be executed.

3. Stop Condition (Stop Bit Recognition)

Each command can be ended by a stop condition (stop bit) that SDA goes from ‘LOW’ to ‘HIGH’ while SCL is ‘HIGH’.

4. Acknowledge (ACK) Signal

- (1) The acknowledge (ACK) signal is a software rule to indicate whether or not data transfer was performed normally. In both controller and target communication, the device at the transmitter (sending) side releases the bus after outputting 8-bit data. When a target address of a write command or a read command is input, microcontroller is the device at the transmitter side. When data output for a read command, this IC is the device at the transmitter side.
- (2) The device on the receiver (receiving) side sets SDA ‘LOW’ during the 9th clock cycle, and outputs an ACK signal showing that the 8-bit data has been received. When a target address of a write command or a read command is input, this IC is the device at the receiver side. When data output for a read command, microcontroller is the device at the receiver side.
- (3) This IC outputs ACK signal ‘LOW’ after recognizing start condition and target address (8 bit).
- (4) Each write operation outputs ACK signal ‘LOW’ every 8-bit data (a word address and write data) reception.
- (5) During read operation, this IC outputs 8-bit data (read data) and detects the ACK signal ‘LOW’. When ACK signal is detected, and no stop condition is sent from the controller (microcontroller) side, this IC continues to output data. If the ACK signal is not detected, this IC stops data transfer, recognizes the stop condition (stop bit), and ends the read operation. Then this IC is ready for another transmission.

5. Device Addressing

- (1) From the controller, input the target address after the start condition.
- (2) The significant 4 bits of target address are used for recognizing a device type. The device code of this IC is fixed to ‘1010’.
- (3) Next target address (P1, P0 --- page select) are for selection page addresses.
- (4) The least significant bit (R / W --- READ/ WRITE) of target address is used for designating write or read operation, and is as shown below.

Setting $\overline{R/W}$ to 0 ----- write (setting 0 to word address setting of random read)

Setting $\overline{R/W}$ to 1 ----- read

Target address	Maximum number of Connected buses
1 0 1 0 * P1 P0 $\overline{R/W}$	1

* don't care

Write Command

1. Write

- (1) Write commands can be used to write data to EEPROM. Write can be Byte Write or Page Write. When only 1 byte is to be written, use Byte Write. When 2 or more bytes of continuous data are written, up to 16 bytes can be written simultaneously by Page Write.

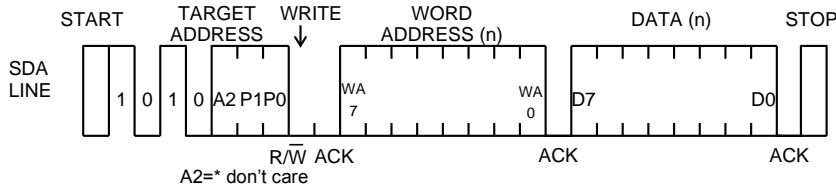

* Don't Care bit

Figure 37. Byte Write

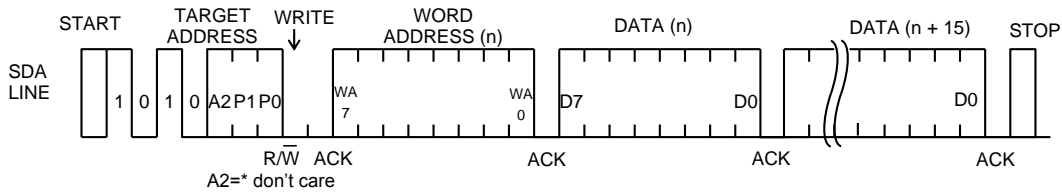

* Don't Care bit

Figure 38. Page Write

- (2) During write execution, all input commands are ignored, therefore ACK is not returned.
- (3) Data is written to the address (n-th address) specified by the word address.
- (4) By issuing stop bit after 8 bit data input, write to memory cell starts.
- (5) When write is started, command is not accepted for t_{WR} (5 ms at maximum).
- (6) For Page Write, after the address (n-th address) is specified with the word address, then 2 bytes or more data are input in succession, the lower 4 bits of the word address are incremented inside EEPROM, and up to 16 bytes of data can be written from the specified address (n-th address).
- (7) When the data exceeding the maximum number of bytes is sent in Page Write, the data of the first byte is overwritten in order.
(Refer to "Internal Address Increment".)
- (8) When V_{CC} is turned off during write execution, data at the designated address is not guaranteed, please write it again.

1 page = 16 bytes, but the write time of page write is 5 ms at maximum for 16 byte batch write.
It is not equal to 5 ms at maximum x 16 byte = 80 ms (Max).

2. Internal Address Increment During Page Write

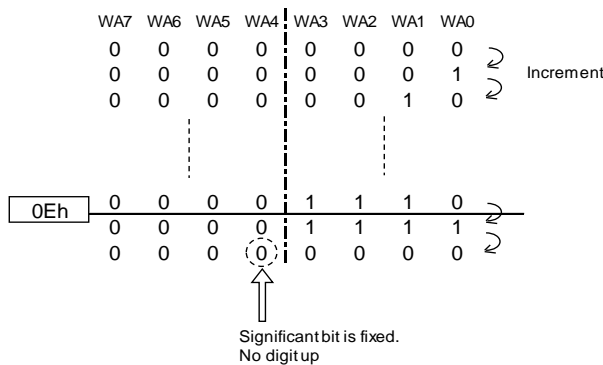

For example, when starting from address 0Eh, then, 0Eh→0Fh→00h→01h... Please take note that it is incremented.

*0Eh...0E in hexadecimal, therefore, 00001110 is a binary number.

Read Command

Read commands can be used to read the EEPROM data. Read has a random read and a current read functions. Random read is commonly used in commands that specify addresses and read data. The current read is a command to read data of the internal address register without specifying an address. In both read functions, sequential read is possible that the next address data can be read in succession.

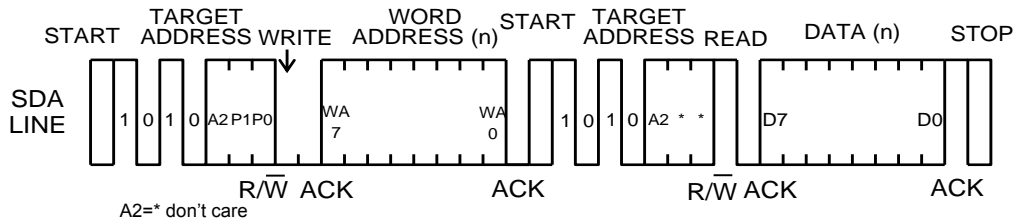

Figure 39. Random Read

*Don't Care bit

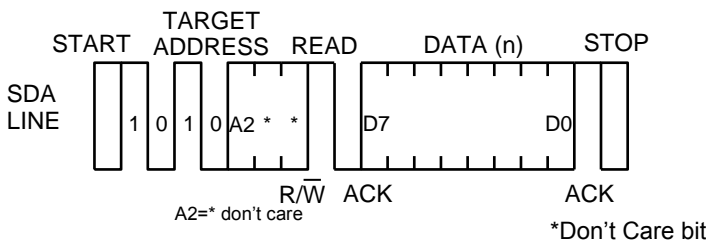

Figure 40. Current Read

*Don't Care bit

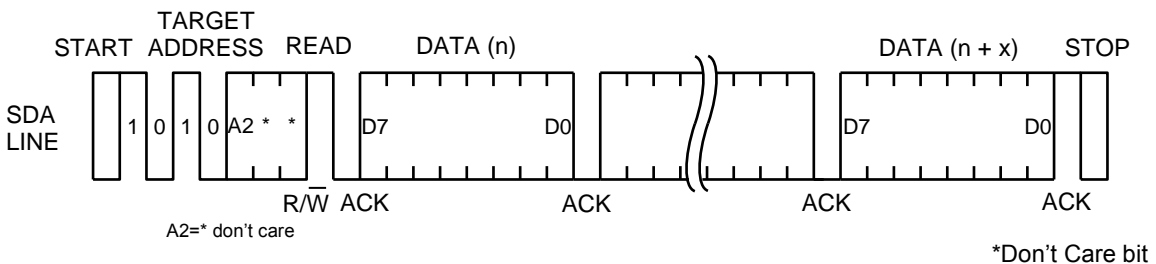

Figure 41. Sequential Read (in the Case of Current Read)

*Don't Care bit

- (1) In random read, data of designated word address can be read.
- (2) When the command just before current read is random read or current read (each including sequential read), if last read address is (n)-th, data of the incremented address (n + 1)-th is outputted.
- (3) When ACK signal 'LOW' is detected after D0, and stop condition is not sent from controller (microcontroller) side, the next address data can be read in succession.
- (4) Read is ended by stop condition that 'HIGH' is input to ACK signal after D0 and SDA signal goes from 'LOW' to 'HIGH' while at SCL signal is 'HIGH'.
- (5) When 'LOW' is input at ACK signal after D0 without 'HIGH' input, sequential read gets in, and the next data is outputted. Therefore, read command cannot be ended. To end read command, be sure to input 'HIGH' to ACK signal after D0, and the stop condition that SDA goes from 'LOW' to 'HIGH' while SCL signal is 'HIGH'.
- (6) Sequential read is ended by stop condition that 'HIGH' is input to ACK signal after arbitrary D0 and SDA goes from 'LOW' to 'HIGH' while SCL signal is 'HIGH'.

Method of Reset

This IC is equipped with Power-on Reset circuit, which is described later, and is reset at power-up. Also, by continuously input start condition and stop condition, reset can be done without restarting the power supply. Execute the reset by start condition and stop condition when it is necessary to reset after power-up, or during command input timing. However, the start condition and stop condition could not be applied because 'HIGH' input of microcontroller and 'LOW' output of EEPROM collide when EEPROM is 'LOW' in ACK output section and data reading. In that case, input SCL clock until SDA bus is released ('HIGH' by pull-up). After confirming that SDA bus is released, continuously input start condition and stop condition. If SDA bus could not be confirmed whether released or not in microcontroller, input the software reset. If software reset is run, EEPROM can be reset without confirming the SDA state because SDA bus is always released in either of the two start conditions. The method of reset is shown in the table below.

Status of SDA	Method of Reset
SDA bus released ('HIGH' by pull-up)	Continuously input start condition and stop condition.
'LOW'	Input SCL clock until SDA bus is released. After confirm that SDA bus is released, continuously input start condition and stop condition.
Microcontroller cannot confirm if SDA bus is released or not	Using the software reset shown in the figure below, the start condition can be always inputted. Within the dummy clock input area, the SDA bus is needed to be released. For normal commands, start with the start condition input.

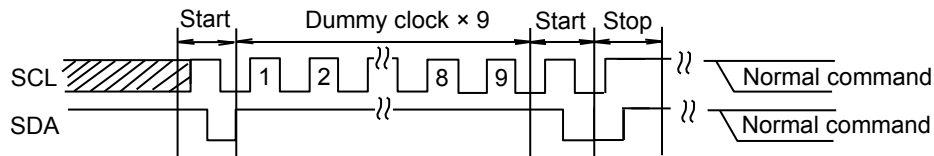

Figure 42. Input Timing of Software Reset

Acknowledge Polling

During write execution, all input commands are ignored, therefore ACK is not returned. During write execution after write input, next command (target address) is sent. If the first ACK signal sends back 'LOW', then it means end of write operation, else 'HIGH' is returned, which means writing is still in progress. By the use of acknowledge polling, next command can be executed without waiting for $t_{WR} = 5$ ms.

To write continuously, target address with $R/\bar{W} = 0$, then to carry out current read after write, target address with $R/\bar{W} = 1$ is sent. If ACK signal sends back 'LOW', then execute word address input and data output and so forth.

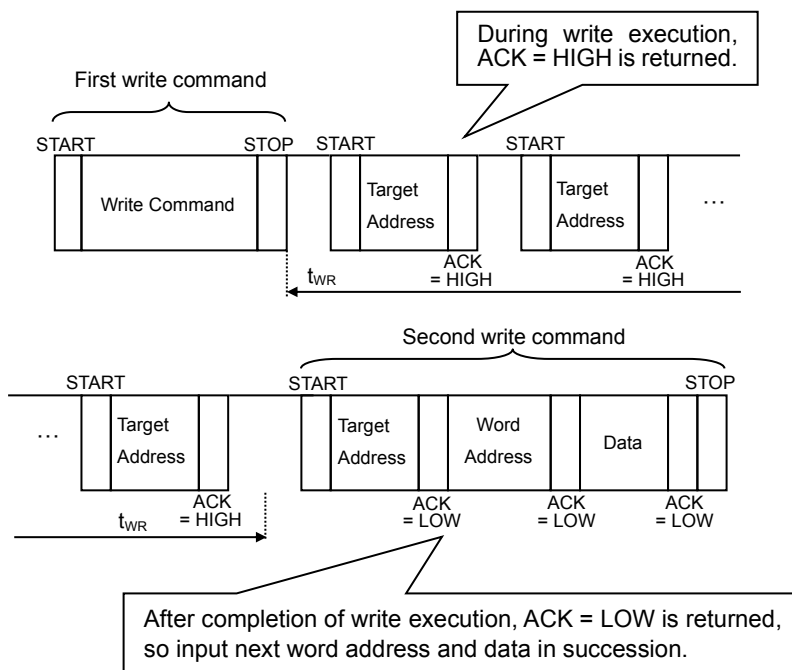

Figure 43. The Case of Continuous Write by Acknowledge Polling

Command Cancel by Start Condition and Stop Condition

During command input, by continuously inputting start condition and stop condition, command can be cancelled. However, within ACK output area and during data read, SDA bus may output 'LOW'. In this case, start condition and stop condition cannot be inputted, so reset is not available. Therefore, execution of reset is needed referring "Method of Reset". When command is cancelled by start-stop condition during random read, sequential read, or current read, internal address setting is not determined. Therefore, it is not possible to carry out current read in succession. To carry out read in succession, carry out random read.

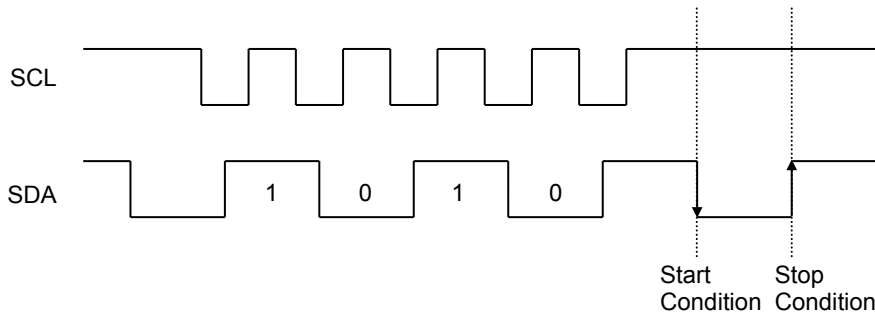

Figure 44. The Case of Cancel by Start, Stop Condition during Target Address Input

Application Examples

1. I/O Peripheral Circuit

(1) Pull-up Resistance of the SDA Pin

SDA is NMOS open drain, so it requires a pull-up resistor. As for this resistor value (R_{PU}), select an appropriate value from microcontroller V_{IL} , I_L , and V_{OL-IOL} characteristics of this IC. If R_{PU} is large, operating frequency is limited. The smaller the R_{PU} increases the supply current.

(2) Maximum Value of R_{PU}

The maximum value of R_{PU} is determined by the following factors.

- (a) SDA rise time determined by the capacitance (C_{BUS}) of bus line of SDA and R_{PU} should be t_R or lower. Furthermore, AC timing should be satisfied even when SDA rise time is slow.
- (b) The bus electric potential A to be determined by input current leak total (I_L) of the device connected to bus at output of 'HIGH' to SDA line and R_{PU} should sufficiently secure the input 'HIGH' level (V_{IH}) of microcontroller and EEPROM including recommended noise margin of $0.2V_{CC}$.

$$V_{CC} - I_L R_{PU} - 0.2V_{CC} \geq V_{IH}$$

$$\therefore R_{PU} \leq \frac{0.8V_{CC} - V_{IH}}{I_L}$$

E.g.) $V_{CC} = 3\text{ V}$, $I_L = 10\ \mu\text{A}$, $V_{IH} = 0.7V_{CC}$
from (b)

$$\therefore R_{PU} \leq \frac{0.8 \times 3 - 0.7 \times 3}{10 \times 10^{-6}}$$

$$\leq 30\ [\text{k}\Omega]$$

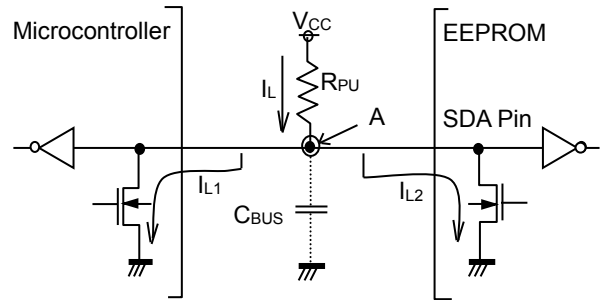

Figure 45. I/O Circuit Diagram

(3) Minimum Value of R_{PU}

The minimum value of R_{PU} is determined by the following factors.

- (a) When IC outputs 'LOW', the bus electric potential A should be equal to or less than output 'LOW' level (V_{OL}) of EEPROM.

$$\frac{V_{CC} - V_{OL}}{R_{PU}} \leq I_{OL}$$

$$\therefore R_{PU} \geq \frac{V_{CC} - V_{OL}}{I_{OL}}$$

E.g.) $V_{CC} = 3\text{ V}$, $V_{OL} = 0.4\text{ V}$, $I_{OL} = 3.2\text{ mA}$, microcontroller, EEPROM $V_{IL} = 0.3V_{CC}$

$$\therefore R_{PU} \geq \frac{3 - 0.4}{3.2 \times 10^{-3}}$$

$$\geq 812.5\ [\Omega]$$

(4) Pull-up Resistance of the SCL Pin

When SCL control is made at the CMOS output port, there is no need for a pull-up resistor. But when there is a time that SCL becomes 'Hi-Z', add a pull-up resistor. As for the pull-up resistor value, decide with the balance with drive performance of output port of microcontroller.

Application Examples - continued

2. Cautions on Microcontroller Connection

(1) R_S

In I²C BUS, it is recommended that SDA port is open drain input/output. However, when using CMOS input/output of tri state to SDA port, insert a series resistance R_S between the pull-up resistor R_{PU} and the SDA pin of EEPROM. This is to control over current that may occur when PMOS of the microcontroller and NMOS of EEPROM are turned ON simultaneously. R_S also plays the role of protecting the SDA pin against surge. Therefore, even when SDA port is open drain input/output, R_S can be used.

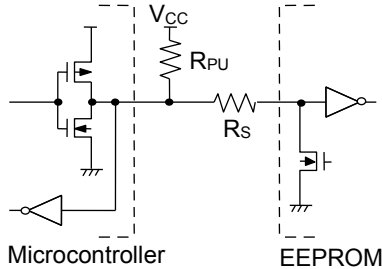
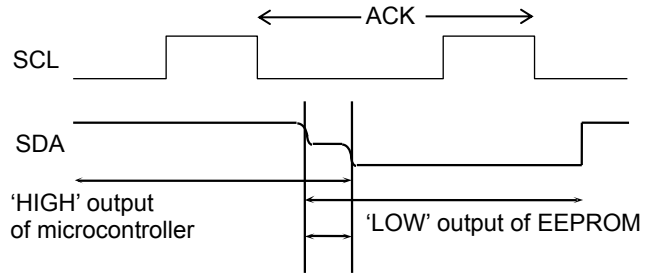

Figure 46. I/O Circuit Diagram



Over current flows to SDA line by 'HIGH' output of microcontroller and 'LOW' output of EEPROM.

Figure 47. I/O Collision Timing

(2) Maximum Value of R_S

The maximum value of R_S is determined by the following relations.

- (a) SDA rise time determined by the capacitance (C_{BUS}) of bus line of SDA and R_{PU} should be t_R or lower. Furthermore, AC timing should be satisfied even when SDA rise time is slow.
- (b) The bus electric potential A to be determined by R_{PU} and R_S when EEPROM outputs 'LOW' to SDA bus should sufficiently secure the input 'LOW' level (V_{IL}) of microcontroller including recommended noise margin of $0.1V_{CC}$.

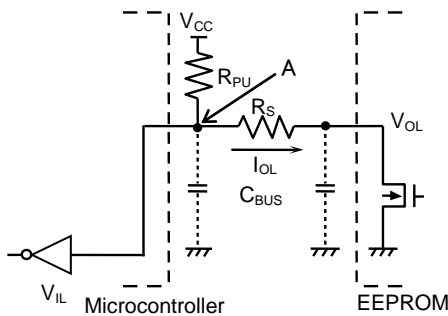

Figure 48. I/O Circuit Diagram

$$\frac{(V_{CC} - V_{OL}) \times R_S}{R_{PU} + R_S} + V_{OL} + 0.1V_{CC} \leq V_{IL}$$

$$\therefore R_S \leq \frac{V_{IL} - V_{OL} - 0.1V_{CC}}{1.1V_{CC} - V_{IL}} \times R_{PU}$$

E.g.) $V_{CC} = 3 \text{ V}$, $V_{IL} = 0.3V_{CC}$, $V_{OL} = 0.4 \text{ V}$, $R_{PU} = 20 \text{ k}\Omega$

$$R_S \leq \frac{0.3 \times 3 - 0.4 - 0.1 \times 3}{1.1 \times 3 - 0.3 \times 3} \times 20 \times 10^3$$

$$\leq 1.67 \text{ [k}\Omega\text{]}$$

(3) Minimum Value of R_S

The minimum value of R_S is determined by over current at bus collision. When over current flows, noises in power source line and instantaneous power failure of power source may occur. When allowable over current is defined as I , the following relation must be satisfied. Determine the allowable current in consideration of the impedance of power source line in set and so forth.

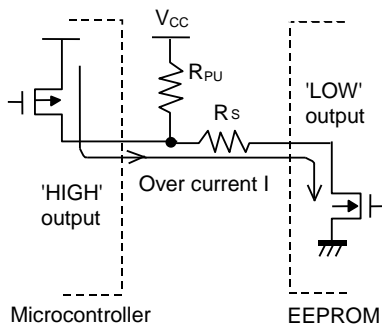

Figure 49. I/O Circuit Diagram

$$\frac{V_{CC}}{R_S} \leq I$$

$$\therefore R_S \geq \frac{V_{CC}}{I}$$

E.g.) $V_{CC} = 3 \text{ V}$, $I = 10 \text{ mA}$

$$R_S \geq \frac{3}{10 \times 10^{-3}}$$

$$\geq 300 \text{ [}\Omega\text{]}$$

Caution on Power-Up Conditions

At power-up, as the V_{CC} rises, the IC's internal circuits may go through unstable low voltage area, making the IC's internal circuit not completely reset, hence, malfunction like miswriting and misreading may occur. To prevent it, this IC is equipped with Power-on Reset circuit. In order to ensure its operation, at power-up, please observe the conditions below. In addition, set the power supply rise so that the supply voltage constantly increases from V_{BOT} to V_{CC} level. Furthermore, t_{INIT} is the time from the power becomes stable to the start of the first command input.

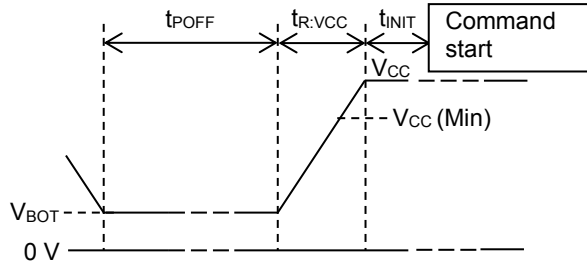

Figure 50. Rise Waveform Diagram

Power-Up Conditions

Parameter	Symbol	Min	Typ	Max	Unit
Supply Voltage at Power OFF	V_{BOT}	-	-	0.3	V
Power OFF Time ^(Note 8)	t_{POFF}	1	-	-	ms
Initialize Time ^(Note 8)	t_{INIT}	0.1	-	-	ms
Supply Voltage Rising Time ^(Note 8)	$t_{R.VCC}$	0.001	-	100	ms

(Note 8) Not 100 % Tested.

If the above conditions are not followed, the POR circuit does not operate properly, the logic circuit of internal IC is undefined. At this time, there is a possibility that IC may not be able to input commands because EEPROM may output 'LOW' and it collide with 'HIGH' input of microcontroller. However, SDA bus can be released by resetting the IC. Refer to the page "Method of Reset" for reset details.

I/O Equivalence Circuits

1. Input (SCL)

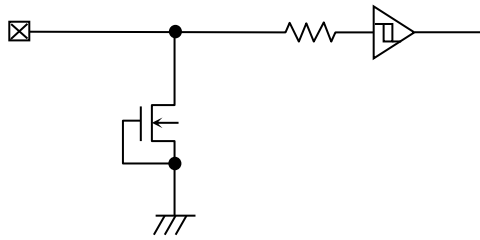

Figure 51. Input Pin Circuit Diagram (SCL)

2. Input/Output (SDA)

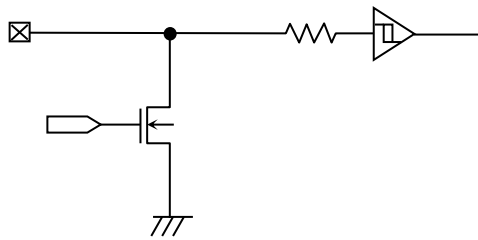

Figure 52. Input/Output Pin Circuit Diagram (SDA)

Operational Notes

1. Reverse Connection of Power Supply

Connecting the power supply in reverse polarity can damage the IC. Take precautions against reverse polarity when connecting the power supply, such as mounting an external diode between the power supply and the IC's power supply pins.

2. Power Supply Lines

Design the PCB layout pattern to provide low impedance supply lines. Furthermore, connect a capacitor to ground at all power supply pins. Consider the effect of temperature and aging on the capacitance value when using electrolytic capacitors.

3. Ground Voltage

Ensure that no pins are at a voltage below that of the ground pin at any time, even during transient condition.

4. Ground Wiring Pattern

When using both small-signal and large-current ground traces, the two ground traces should be routed separately but connected to a single ground at the reference point of the application board to avoid fluctuations in the small-signal ground caused by large currents. Also ensure that the ground traces of external components do not cause variations on the ground voltage. The ground lines must be as short and thick as possible to reduce line impedance.

5. Operating Conditions

The function and operation of the IC are guaranteed within the range specified by the operating conditions. The characteristic values are guaranteed only under the conditions of each item specified by the electrical characteristics.

6. Inrush Current

When power is first supplied to the IC, it is possible that the internal logic may be unstable and inrush current may flow instantaneously due to the internal powering sequence and delays, especially if the IC has more than one power supply. Therefore, give special consideration to power coupling capacitance, power wiring, width of ground wiring, and routing of connections.

7. Testing on Application Boards

When testing the IC on an application board, connecting a capacitor directly to a low-impedance output pin may subject the IC to stress. Always discharge capacitors completely after each process or step. The IC's power supply should always be turned off completely before connecting or removing it from the test setup during the inspection process. To prevent damage from static discharge, ground the IC during assembly and use similar precautions during transport and storage.

8. Inter-pin Short and Mounting Errors

Ensure that the direction and position are correct when mounting the IC on the PCB. Incorrect mounting may result in damaging the IC. Avoid nearby pins being shorted to each other especially to ground, power supply and output pin. Inter-pin shorts could be due to many reasons such as metal particles, water droplets (in very humid environment) and unintentional solder bridge deposited in between pins during assembly to name a few.

9. Unused Input Pins

Input pins of an IC are often connected to the gate of a MOS transistor. The gate has extremely high impedance and extremely low capacitance. If left unconnected, the electric field from the outside can easily charge it. The small charge acquired in this way is enough to produce a significant effect on the conduction through the transistor and cause unexpected operation of the IC. So unless otherwise specified, unused input pins should be connected to the power supply or ground line.

10. Regarding the Input Pin of the IC

In the construction of this IC, P-N junctions are inevitably formed creating parasitic diodes or transistors. The operation of these parasitic elements can result in mutual interference among circuits, operational faults, or physical damage. Therefore, conditions which cause these parasitic elements to operate, such as applying a voltage to an input pin lower than the ground voltage should be avoided. Furthermore, do not apply a voltage to the input pins when no power supply voltage is applied to the IC. Even if the power supply voltage is applied, make sure that the input pins have voltages within the values specified in the electrical characteristics of this IC.

11. Ceramic Capacitor

When using a ceramic capacitor, determine a capacitance value considering the change of capacitance with temperature and the decrease in nominal capacitance due to DC bias and others.

Operational Notes – continued**12. Disturbance Light**

In a device where a portion of silicon is exposed to light such as in a WL-CSP and chip products, IC characteristics may be affected due to photoelectric effect. For this reason, it is recommended to come up with countermeasures that will prevent the chip from being exposed to light.

Ordering Information

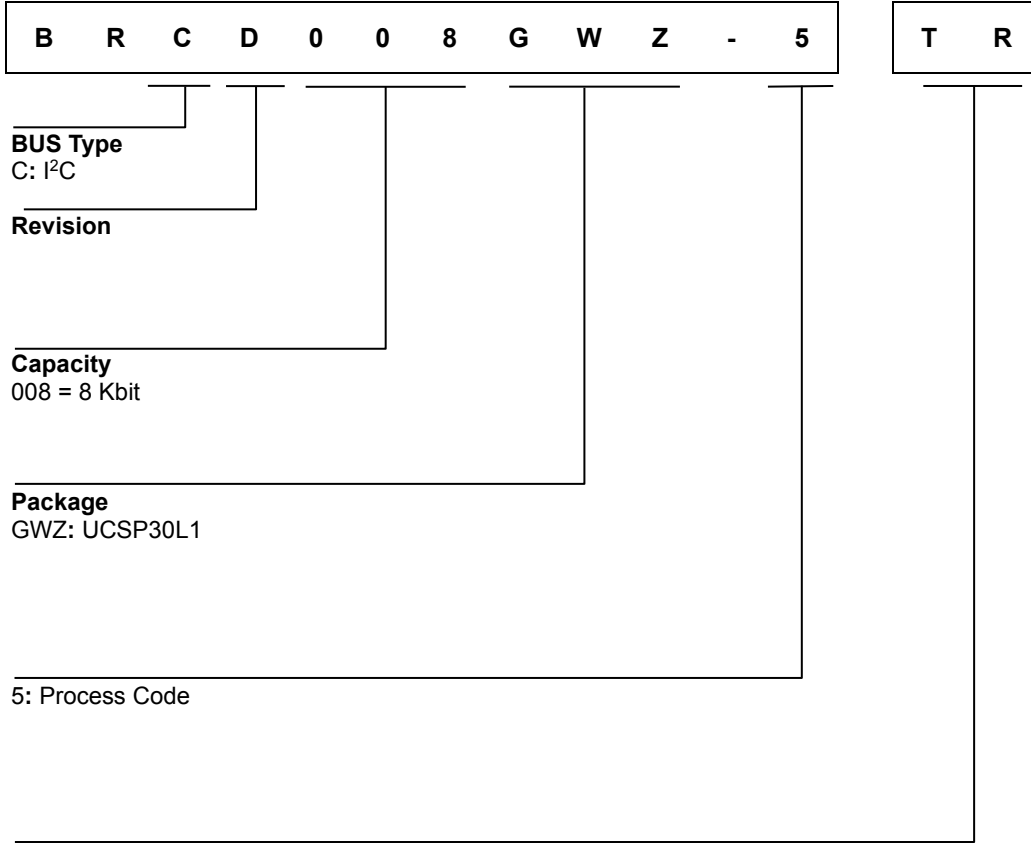

Marking Diagram

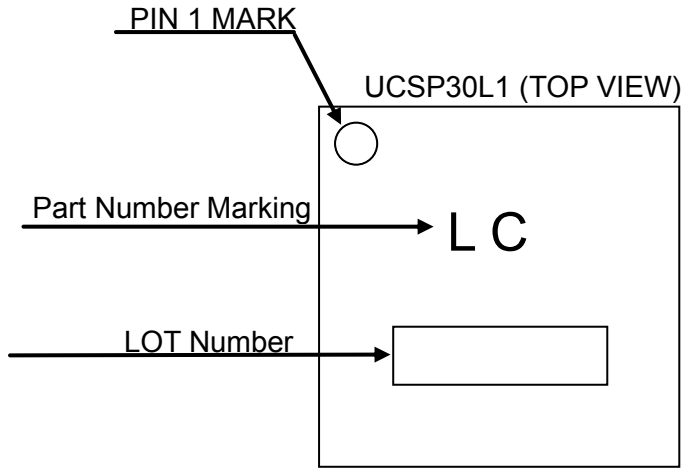

Physical Dimension and Packing Information

Package Name	UCSP30L1 (BRCD008GWZ-5)
--------------	-------------------------

EXTERNAL DIMENSIONS FOR USER

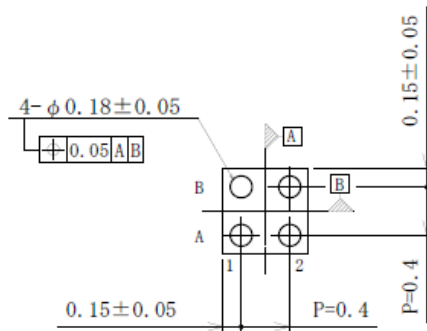
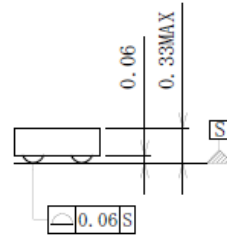
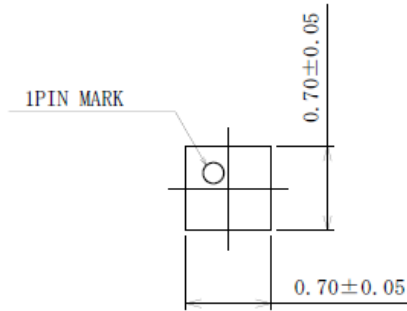

(UNIT: mm)

Drawing No. :EX938-5047

< Tape and Reel Information >

Tape	Embossed carrier tape
Quantity	6000pcs
Direction of feed	TR The direction is the pin 1 of product is at the upper right when you hold reel on the left hand and you pull out the tape on the right hand.

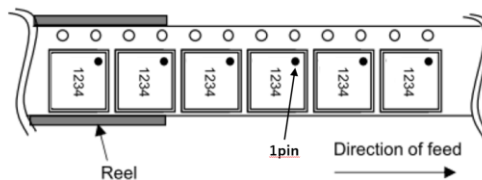

Revision History

Date	Revision	Changes
30.Oct.2023	001	New Release
09.Sep.2024	002	P1 Change title to WLCSP EEPROM Change package size to 0.70 mm x 0.70 mm x 0.33 mm P5 Change V_{OL1} condition to $2.5\text{ V} \leq V_{CC} \leq 3.6\text{ V}$ P9 Delete graph of Input Leakage Current 1 Change graph of Input Leakage Current 2 P29 Change EXTERNAL DEMENSIONS

Notice

Precaution on using ROHM Products

- Our Products are designed and manufactured for application in ordinary electronic equipment (such as AV equipment, OA equipment, telecommunication equipment, home electronic appliances, amusement equipment, etc.). If you intend to use our Products in devices requiring extremely high reliability (such as medical equipment ^(Note 1), transport equipment, traffic equipment, aircraft/spacecraft, nuclear power controllers, fuel controllers, car equipment including car accessories, safety devices, etc.) and whose malfunction or failure may cause loss of human life, bodily injury or serious damage to property ("Specific Applications"), please consult with the ROHM sales representative in advance. Unless otherwise agreed in writing by ROHM in advance, ROHM shall not be in any way responsible or liable for any damages, expenses or losses incurred by you or third parties arising from the use of any ROHM's Products for Specific Applications.

(Note1) Medical Equipment Classification of the Specific Applications

JAPAN	USA	EU	CHINA
CLASS III	CLASS III	CLASS II b	CLASS III
CLASS IV		CLASS III	

- ROHM designs and manufactures its Products subject to strict quality control system. However, semiconductor products can fail or malfunction at a certain rate. Please be sure to implement, at your own responsibilities, adequate safety measures including but not limited to fail-safe design against the physical injury, damage to any property, which a failure or malfunction of our Products may cause. The following are examples of safety measures:
 - Installation of protection circuits or other protective devices to improve system safety
 - Installation of redundant circuits to reduce the impact of single or multiple circuit failure
- Our Products are designed and manufactured for use under standard conditions and not under any special or extraordinary environments or conditions, as exemplified below. Accordingly, ROHM shall not be in any way responsible or liable for any damages, expenses or losses arising from the use of any ROHM's Products under any special or extraordinary environments or conditions. If you intend to use our Products under any special or extraordinary environments or conditions (as exemplified below), your independent verification and confirmation of product performance, reliability, etc. prior to use, must be necessary:
 - Use of our Products in any types of liquid, including water, oils, chemicals, and organic solvents
 - Use of our Products outdoors or in places where the Products are exposed to direct sunlight or dust
 - Use of our Products in places where the Products are exposed to sea wind or corrosive gases, including Cl₂, H₂S, NH₃, SO₂, and NO₂
 - Use of our Products in places where the Products are exposed to static electricity or electromagnetic waves
 - Use of our Products in proximity to heat-producing components, plastic cords, or other flammable items
 - Sealing or coating our Products with resin or other coating materials
 - Use of our Products without cleaning residue of flux (Exclude cases where no-clean type fluxes is used. However, recommend sufficiently about the residue.) ; or Washing our Products by using water or water-soluble cleaning agents for cleaning residue after soldering
 - Use of the Products in places subject to dew condensation
- The Products are not subject to radiation-proof design.
- Please verify and confirm characteristics of the final or mounted products in using the Products.
- In particular, if a transient load (a large amount of load applied in a short period of time, such as pulse, is applied, confirmation of performance characteristics after on-board mounting is strongly recommended. Avoid applying power exceeding normal rated power; exceeding the power rating under steady-state loading condition may negatively affect product performance and reliability.
- De-rate Power Dissipation depending on ambient temperature. When used in sealed area, confirm that it is the use in the range that does not exceed the maximum junction temperature.
- Confirm that operation temperature is within the specified range described in the product specification.
- ROHM shall not be in any way responsible or liable for failure induced under deviant condition from what is defined in this document.

Precaution for Mounting / Circuit board design

- When a highly active halogenous (chlorine, bromine, etc.) flux is used, the residue of flux may negatively affect product performance and reliability.
- In principle, the reflow soldering method must be used on a surface-mount products, the flow soldering method must be used on a through hole mount products. If the flow soldering method is preferred on a surface-mount products, please consult with the ROHM representative in advance.

For details, please refer to ROHM Mounting specification

Precautions Regarding Application Examples and External Circuits

1. If change is made to the constant of an external circuit, please allow a sufficient margin considering variations of the characteristics of the Products and external components, including transient characteristics, as well as static characteristics.
2. You agree that application notes, reference designs, and associated data and information contained in this document are presented only as guidance for Products use. Therefore, in case you use such information, you are solely responsible for it and you must exercise your own independent verification and judgment in the use of such information contained in this document. ROHM shall not be in any way responsible or liable for any damages, expenses or losses incurred by you or third parties arising from the use of such information.

Precaution for Electrostatic

This Product is electrostatic sensitive product, which may be damaged due to electrostatic discharge. Please take proper caution in your manufacturing process and storage so that voltage exceeding the Products maximum rating will not be applied to Products. Please take special care under dry condition (e.g. Grounding of human body / equipment / solder iron, isolation from charged objects, setting of Ionizer, friction prevention and temperature / humidity control).

Precaution for Storage / Transportation

1. Product performance and soldered connections may deteriorate if the Products are stored in the places where:
 - [a] the Products are exposed to sea winds or corrosive gases, including Cl₂, H₂S, NH₃, SO₂, and NO₂
 - [b] the temperature or humidity exceeds those recommended by ROHM
 - [c] the Products are exposed to direct sunshine or condensation
 - [d] the Products are exposed to high Electrostatic
2. Even under ROHM recommended storage condition, solderability of products out of recommended storage time period may be degraded. It is strongly recommended to confirm solderability before using Products of which storage time is exceeding the recommended storage time period.
3. Store / transport cartons in the correct direction, which is indicated on a carton with a symbol. Otherwise bent leads may occur due to excessive stress applied when dropping of a carton.
4. Use Products within the specified time after opening a humidity barrier bag. Baking is required before using Products of which storage time is exceeding the recommended storage time period.

Precaution for Product Label

A two-dimensional barcode printed on ROHM Products label is for ROHM's internal use only.

Precaution for Disposition

When disposing Products please dispose them properly using an authorized industry waste company.

Precaution for Foreign Exchange and Foreign Trade act

Since concerned goods might be fallen under listed items of export control prescribed by Foreign exchange and Foreign trade act, please consult with ROHM in case of export.

Precaution Regarding Intellectual Property Rights

1. All information and data including but not limited to application example contained in this document is for reference only. ROHM does not warrant that foregoing information or data will not infringe any intellectual property rights or any other rights of any third party regarding such information or data.
2. ROHM shall not have any obligations where the claims, actions or demands arising from the combination of the Products with other articles such as components, circuits, systems or external equipment (including software).
3. No license, expressly or implied, is granted hereby under any intellectual property rights or other rights of ROHM or any third parties with respect to the Products or the information contained in this document. Provided, however, that ROHM will not assert its intellectual property rights or other rights against you or your customers to the extent necessary to manufacture or sell products containing the Products, subject to the terms and conditions herein.

Other Precaution

1. This document may not be reprinted or reproduced, in whole or in part, without prior written consent of ROHM.
2. The Products may not be disassembled, converted, modified, reproduced or otherwise changed without prior written consent of ROHM.
3. In no event shall you use in any way whatsoever the Products and the related technical information contained in the Products or this document for any military purposes, including but not limited to, the development of mass-destruction weapons.
4. The proper names of companies or products described in this document are trademarks or registered trademarks of ROHM, its affiliated companies or third parties.

General Precaution

1. Before you use our Products, you are requested to carefully read this document and fully understand its contents. ROHM shall not be in any way responsible or liable for failure, malfunction or accident arising from the use of any ROHM's Products against warning, caution or note contained in this document.
2. All information contained in this document is current as of the issuing date and subject to change without any prior notice. Before purchasing or using ROHM's Products, please confirm the latest information with a ROHM sales representative.
3. The information contained in this document is provided on an "as is" basis and ROHM does not warrant that all information contained in this document is accurate and/or error-free. ROHM shall not be in any way responsible or liable for any damages, expenses or losses incurred by you or third parties resulting from inaccuracy or errors of or concerning such information.