

Gate Driver Providing Galvanic Isolation Series

Isolation Voltage 3750 Vrms

1ch Gate Driver Providing Galvanic Isolation

BM6112HFV-C

General Description

BM6112HFV-C is a gate driver with isolation voltage of 3750 Vrms, I/O delay time of 150 ns, and incorporates fault signal output function, ready signal output function, under voltage lockout (UVLO) function, short circuit protection (SCP) function, active miller clamping function, output state feedback function and temperature monitor function.

Key Specifications

- Isolation Voltage 3750 Vrms
- Maximum Gate Drive Voltage: 20 V
- I/O Delay Time: 150 ns (Max)
- Minimum Input Pulse Width: 90 ns

Package

SSOP-B28WR6 W (Typ) x D (Typ) x H (Max)
9.2 mm x 10.4 mm x 2.4 mm

Features

- AEC-Q100 Qualified (Note 1)
- Fault Signal Output Function
- Ready Signal Output Function
- Under Voltage Lockout Function
- Short Circuit Protection Function
- Active Miller Clamping Function
- Output State Feedback Function
- Temperature Monitor Function
- IEC60747-17 Recognized: File No. R 50593938

(Note 1) Grade1



Applications

- Automotive Inverter
- Automotive DC-DC Converter
- Industrial Inverter System
- UPS System

Typical Application Circuit

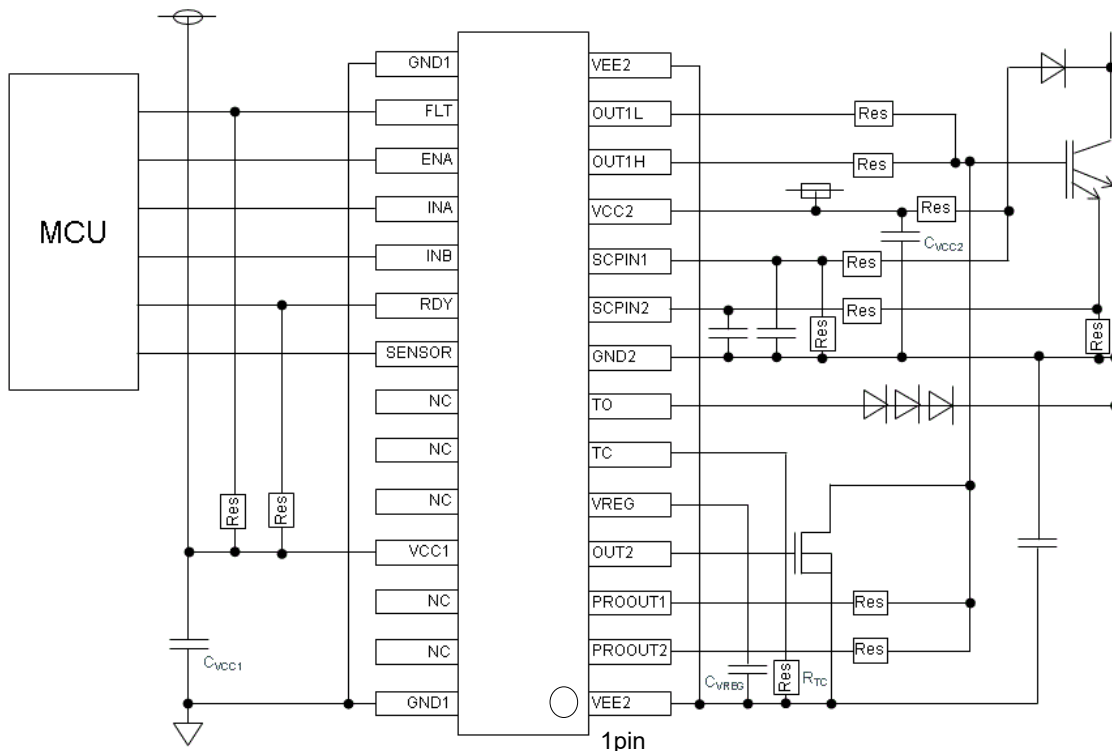

○Product structure : Silicon integrated circuit ○This product has no designed protection against radioactive rays.

Contents

General Description.....	1
Features.....	1
Applications	1
Key Specifications.....	1
Package	1
Typical Application Circuit.....	1
Contents	2
Recommended Range of External Constants	3
Pin Configuration.....	3
Pin Description	3
Block Diagram.....	4
Absolute Maximum Ratings.....	4
Thermal Resistance.....	5
Recommended Operating Conditions.....	5
Insulation Related Characteristics	6
Electrical Characteristics	7
Typical Performance Curves.....	9
Application Information.....	23
I/O Equivalence Circuit.....	29
Operational Notes.....	32
Ordering Information.....	34
Marking Diagram.....	34
Physical Dimension and Packing Information	35
Revision History	36

Recommended Range of External Constants

Pin Name	Symbol	Recommended Value			Unit
		Min	Typ	Max	
TC	R _{TC}	1.25	-	50	kΩ
VCC1	C _{VCC1}	0.1	0.22	-	μF
VCC2	C _{VCC2}	0.2	-	-	μF
VREG	C _{VREG}	0.01	0.1	0.47	μF

Pin Configuration

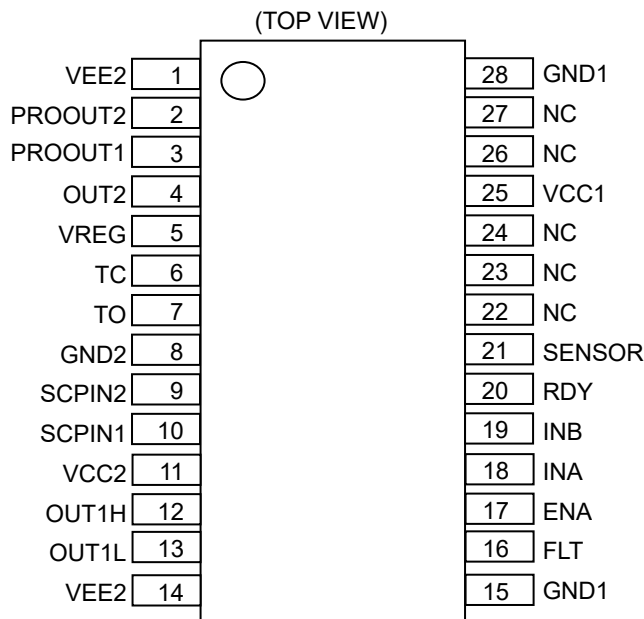

Pin Description

Pin No.	Pin Name	Function
1	VEE2	Output-side negative power supply pin
2	PROOUT2	Soft turn-off pin 2
3	PROOUT1	Soft turn-off pin 1 / Gate voltage input pin
4	OUT2	Gate control pin for active miller clamping
5	VREG	Power supply pin for driving MOSFET for active miller clamping
6	TC	Resistor connection pin for setting constant current source output
7	TO	Constant current output pin / Sensor voltage input pin
8	GND2	Output-side ground pin
9	SCPIN2	Short circuit current detection pin 2
10	SCPIN1	Short circuit current detection pin 1
11	VCC2	Output-side positive power supply pin
12	OUT1H	Source-side output pin
13	OUT1L	Sink-side output pin
14	VEE2	Output-side negative power supply pin
15	GND1	Input-side ground pin
16	FLT	Fault output pin
17	ENA	Input pin for enabling control input signal
18	INA	Control input pin
19	INB	Control input pin
20	RDY	Ready output pin
21	SENSOR	Temperature information output pin
22	NC	Non connection
23	NC	Non connection
24	NC	Non connection
25	VCC1	Input-side power supply pin
26	NC	Non connection
27	NC	Non connection
28	GND1	Input-side ground pin

Block Diagram

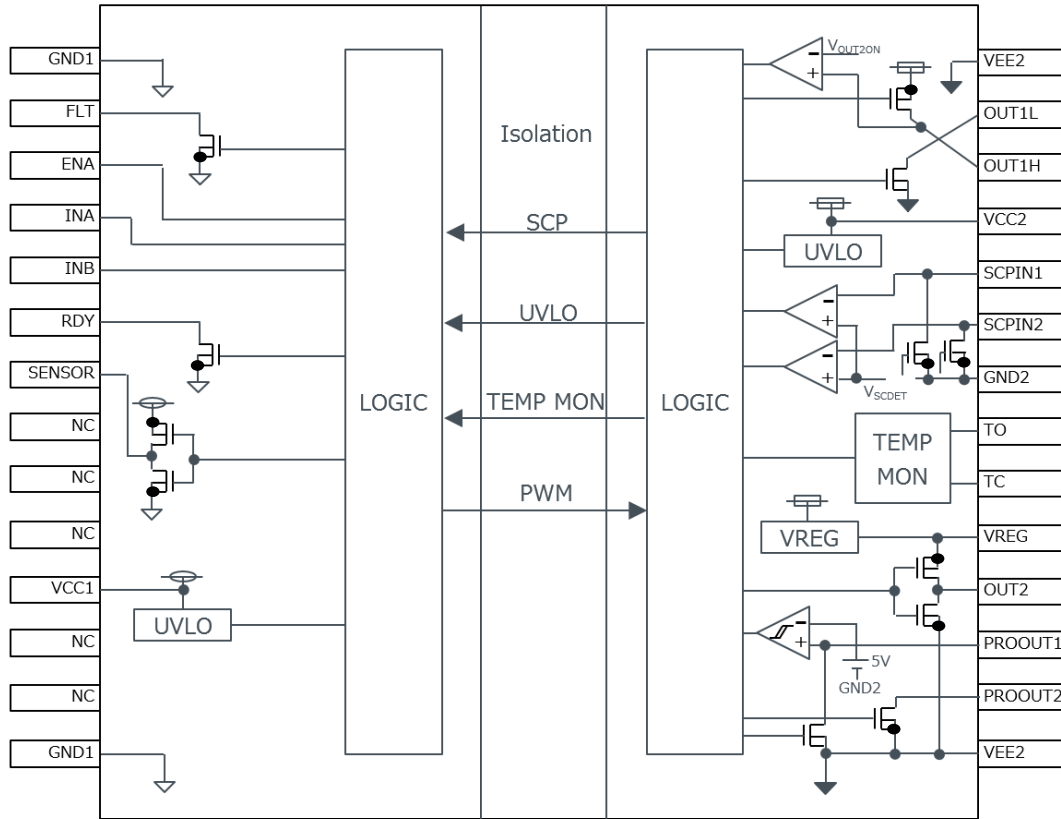

Absolute Maximum Ratings

Parameter	Symbol	Rating	Unit
Input-side Supply Voltage	V_{CC1MAX}	-0.3 to +7.0 ^(Note 2)	V
Output-side Positive Supply Voltage	V_{CC2MAX}	-0.3 to +24.0 ^(Note 3)	V
Output-side Negative Supply Voltage	V_{EE2MAX}	-15.0 to +0.3 ^(Note 3)	V
Maximum Difference between Output-side Positive and Negative Supply Voltages	V_{MAX2}	30.0	V
INA, INB, ENA Pin Input Voltage	V_{INMAX}	-0.3 to $V_{CC1}+0.3$ or +7.0 ^(Note 2)	V
FLT, RDY Pin Input Voltage	V_{FLTMAX}, V_{RDYMAX}	-0.3 to +7.0 ^(Note 2)	V
FLT, RDY Pin Output Current	I_{FLT}, I_{RDY}	10	mA
SENSOR Pin Output Current	I_{SENSOR}	10	mA
SCPIN1, SCPIN2 Pin Input Voltage	$V_{SCPINMAX}$	-0.3 to $V_{CC2}+0.3$ or +24.0 ^(Note 3)	V
TO Pin Input Voltage	V_{TOMAX}	-0.3 to $V_{CC2}+0.3$ or +24.0 ^(Note 3)	V
TO Pin Output Current	I_{TOMAX}	1	mA
Storage Temperature Range	Tstg	-55 to +150	°C
Maximum Junction Temperature	T_{jmax}	+150	°C

Caution 1: Operating the IC over the absolute maximum ratings may damage the IC. The damage can either be a short circuit between pins or an open circuit between pins and the internal circuitry. Therefore, it is important to consider circuit protection measures, such as adding a fuse, in case the IC is operated over the absolute maximum ratings.

Caution 2: Should by any chance the maximum junction temperature rating be exceeded the rise in temperature of the chip may result in deterioration of the properties of the chip. In case of exceeding this absolute maximum rating, design a PCB with thermal resistance taken into consideration by increasing board size and copper area so as not to exceed the maximum junction temperature rating.

(Note 2) Relative to GND1
 (Note 3) Relative to GND2

Thermal Resistance (Note 4)

Parameter	Symbol	Thermal Resistance (Typ)		Unit
		1s <small>(Note 6)</small>	2s2p <small>(Note 7)</small>	
SSOP-B28WR6				
Junction to Ambient	θ_{JA}	112.9	64.4	°C/W
Junction to Top Characterization Parameter <small>(Note 5)</small>	Ψ_{JT}	34	23	°C/W

(Note 4) Based on JESD51-2A(Still-Air)

(Note 5) The thermal characterization parameter to report the difference between junction temperature and the temperature at the top center of the outside surface of the component package.

(Note 6) Using a PCB board based on JESD51-3.

(Note 7) Using a PCB board based on JESD51-7.

Layer Number of Measurement Board	Material	Board Size
Single	FR-4	114.3 mm x 76.2 mm x 1.57 mmt

Top	
Copper Pattern	Thickness
Footprints and Traces	70 μ m

Layer Number of Measurement Board	Material	Board Size
4 Layers	FR-4	114.3 mm x 76.2 mm x 1.6 mmt

Top		2 Internal Layers		Bottom	
Copper Pattern	Thickness	Copper Pattern	Thickness	Copper Pattern	Thickness
Footprints and Traces	70 μ m	74.2 mm x 74.2 mm	35 μ m	74.2 mm x 74.2 mm	70 μ m

Recommended Operating Conditions

Parameter	Symbol	Min	Max	Unit
Input-side Supply Voltage	V_{CC1} <small>(Note 8)</small>	4.5	5.5	V
Output-side Positive Supply Voltage	V_{CC2} <small>(Note 9)</small>	14	20	V
Output-side Negative Supply Voltage	V_{EE2} <small>(Note 9)</small>	-12	0	V
Maximum Difference between Output-side Positive and Negative Supply Voltages	V_{MAX2}	-	28	V
Operating Temperature	T_{opr}	-40	+125	°C

(Note 8) Relative to GND1

(Note 9) Relative to GND2

Insulation Related Characteristics

Reinforced Insulation Requirements according to IEC60747-17

Parameter	Symbol	Characteristic	Unit
Climatic Classification	-	40/125/21	-
Pollution Decree (EN 60664-1)	-	2	-
Minimum External Clearance	CLR	8.2	mm
Minimum External Creepage	CPG	8.2	mm
Minimum Thickness of Internal Isolation Structure	-	0.014	mm
Minimum Comparative Tracking Index	CTI	>600	-
Maximum Working Isolation Voltage	V_{IOWM}	849	Vrms
Maximum Repetitive Isolation Voltage	V_{IORM}	1200	Vpeak
Input to Output Test Voltage, Method b $V_{IORM} * 1.875 = V_{PR}$, Productive Test, $t_m = 1$ s, Partial Discharge < 5 pC	V_{PR}	2250	
Maximum Transient Isolation Voltage, 1 min	V_{IOTM}	5303	
Maximum Transient Isolation Voltage, 1 s	-	6364	
Maximum Surge Isolation Voltage	V_{IOSM}	6000	
Maximum Impulse Voltage	V_{IMP}	4615	
Maximum Withstanding Isolation Voltage	V_{ISO}	3750	Vrms
Insulation Resistance at $T_S = 150$ °C, $V_{IO} = 500$ V	R_{IO}	$>10^9$	Ω

This coupler is suitable for "safe electrical insulation" only within the safety ratings. Compliance with the safety ratings shall be ensured by means of suitable protective circuits.

The Solid insulation of the unit is designed to provide protection against electric hazards with reinforced insulation at the specified safety limiting conditions.

E.g. Installed within a system in accordance with standard EN IEC 60664-1:2020 clause 5.4, which

- Nominal line-to-neutral (neutral-earthed) System or Insulation voltage $U_0/U_i \leq 400$ Vrms / 600 Vpeak;
- Rated impulse voltage $V_{IMP} \leq 2884$ Vpeak (5.4.3.1).

Electrical Characteristics(Unless otherwise specified, Ta = -40 °C to +125 °C, V_{CC1} = 4.5 V to 5.5 V, V_{CC2} = 14 V to 20 V, V_{EE2} = -12 V to 0 V)

Parameter	Symbol	Min	Typ	Max	Unit	Conditions
General						
Input-side Circuit Current 1	I _{CC11}	1.9	3.9	7.8	mA	OUT1L = L
Input-side Circuit Current 2	I _{CC12}	1.9	3.9	7.8	mA	OUT1H = H
Input-side Circuit Current 3	I _{CC13}	2.1	4.3	8.6	mA	INA = 10 kHz, Duty = 50 %
Input-side Circuit Current 4	I _{CC14}	2.3	4.6	9.2	mA	INA = 20 kHz, Duty = 50 %
Output-side Circuit Current	I _{CC2}	1.26	2.80	4.60	mA	R _{TC} = 4.7 kΩ
Logic Block						
Logic High Level Input Voltage	V _{INH}	2.0	-	V _{CC1}	V	INA, INB, ENA
Logic Low Level Input Voltage	V _{INL}	0	-	0.8	V	INA, INB, ENA
Logic Pull-down Resistance	R _{IND}	25	50	100	kΩ	INA, ENA
Logic Pull-up Resistance	R _{INU}	25	50	100	kΩ	INB
Logic Input Filtering Time	t _{INFIL}	-	-	90	ns	INA, INB
ENA Input Filtering Time	t _{ENAFIL}	4	10	20	μs	
Output						
OUT1H ON Resistance	R _{OUT1H}	-	0.20	0.45	Ω	I _{OUT1H} = -40 mA
OUT1L ON Resistance	R _{OUT1L}	-	0.20	0.45	Ω	I _{OUT1L} = 40 mA
OUT1H, OUT1L Maximum Current	I _{OUT1MAX}	20	-	-	A	V _{CC2} = 15 V Guaranteed by design
PROOUT1 ON Resistance	R _{PRO1}	-	0.5	1.1	Ω	I _{PROOUT1} = 40 mA
PROOUT1 Maximum Current	I _{PRO1MAX}	3	-	-	A	V _{CC2} = 15 V Guaranteed by design
PROOUT2 ON Resistance	R _{PRO2}	-	0.20	0.45	Ω	I _{PROOUT2} = 40 mA Guaranteed by design
PROOUT2 Maximum Current	I _{PRO2MAX}	5	-	-	A	V _{CC2} = 15 V Guaranteed by design
Turn ON Time	t _{ON}	40	90	150	ns	
Turn OFF Time	t _{OFF}	40	90	150	ns	
Propagation Distortion	t _{PDIST}	-30	0	+30	ns	t _{OFF} - t _{ON}
Rise Time	t _{RISE}	-	30	50	ns	Load = 1 nF Guaranteed by design
Fall Time	t _{FALL}	-	30	50	ns	Load = 1 nF Guaranteed by design
OUT2 ON Resistance (Source)	R _{OUT2H}	-	2.0	4.5	Ω	I _{OUT2} = -10 mA
OUT2 ON Resistance (Sink)	R _{OUT2L}	-	2.0	4.5	Ω	I _{OUT2} = 10 mA
OUT2 Maximum Current	I _{OUT2MAX}	0.4	-	-	A	Guaranteed by design
OUT2 ON Threshold Voltage	V _{OUT2ON}	1.8	2.0	2.2	V	Relative to VEE2
OUT2 Output Delay Time	t _{DOUT2}	-	135	195	ns	
VREG Output Voltage	V _{REG}	4.5	5.0	5.5	V	Relative to VEE2
Common Mode Transient Immunity	CM	100	-	-	kV/μs	Guaranteed by design

Electrical Characteristics - continued(Unless otherwise specified, Ta = -40 °C to +125 °C, V_{CC1} = 4.5 V to 5.5 V, V_{CC2} = 14 V to 20 V, V_{EE2} = -12 V to 0 V)

Parameter	Symbol	Min	Typ	Max	Unit	Conditions
Temperature Monitor						
TC Pin Voltage	V _{TC}	-	0.94	-	V	
TO Pin Output Current	I _{TO}	196	200	204	μA	R _{TC} = 4.7 kΩ
Maximum Duty	D _{MAX}	88.0	90.0	92.0	%	V _{TO} = 3.84 V
Minimum Duty	D _{MIN}	9.0	10.0	11.0	%	V _{TO} = 1.35 V
SENSOR Output Frequency	f _{SENSOR}	0.7	1.0	1.4	kHz	
Duty Accuracy 1 (Actual - Typ)	D _{ACC1}	-2.0	0	+2.0	%	3.0 V ≤ V _{TO} ≤ 3.84 V
Duty Accuracy 2 (Actual - Typ)	D _{ACC2}	-1.3	0	+1.3	%	2.5 V ≤ V _{TO} < 3.0 V
Duty Accuracy 3 (Actual - Typ)	D _{ACC3}	-1.1	0	+1.1	%	2.0 V ≤ V _{TO} < 2.5 V
Duty Accuracy 4 (Actual - Typ)	D _{ACC4}	-1.0	0	+1.0	%	1.35 V ≤ V _{TO} < 2.0 V
SENSOR ON Resistance (Source-side)	R _{SENSORH}	-	60	160	Ω	I _{SENSOR} = -5 mA
SENSOR ON Resistance (Sink-side)	R _{SENSORL}	-	60	160	Ω	I _{SENSOR} = 5 mA
Protection Functions						
Input-side UVLO OFF Voltage	V _{UVLO1H}	4.05	4.25	4.45	V	
Input-side UVLO ON Voltage	V _{UVLO1L}	3.95	4.15	4.35	V	
Input-side UVLO Filtering Time	t _{UVLO1FIL}	2	10	30	μs	
Output-side UVLO OFF Voltage	V _{UVLO2H}	11.5	12.5	13.5	V	
Output-side UVLO ON Voltage	V _{UVLO2L}	10.5	11.5	12.5	V	
Output-side UVLO Filtering Time	t _{UVLO2FIL}	2	10	30	μs	
Output-side UVLO Delay Time (OUT1H, OUT1L)	t _{DUVLO2OUT}	2	10	30	μs	
Output-side UVLO Delay Time (RDY)	t _{DUVLO2RDY}	3	-	65	μs	
SCPIN Input Voltage	V _{SCPIN}	-	0.10	0.22	V	I _{SCPIN1} , I _{SCPIN2} = 1 mA
SCPIN Leading Edge Blanking Time	t _{SCPINLEB}	0.10	0.20	0.30	μs	SCPIN1, SCPIN2 Guaranteed by design
Short Circuit Detection Voltage	V _{SCDET}	0.67	0.70	0.73	V	SCPIN1, SCPIN2
Short Circuit Detection Filtering Time	t _{SCPFIL}	0.15	0.30	0.45	μs	SCPIN1, SCPIN2
FLT Delay Time	t _{DFLT}	0.2	0.5	0.9	μs	
PROOUT2 ON Time	t _{PRO2ON}	100	160	220	ns	
PROOUT1 H Detection Voltage	V _{OSFBH}	-	5.0	-	V	
PROOUT1 L Detection Voltage	V _{OSFBL}	-	4.5	-	V	
OSFB Output Filtering Time	t _{OSFBFIL}	5.0	7.4	9.8	μs	
RDY Output ON Resistance	R _{RDYL}	-	30	80	Ω	I _{RDY} = 5 mA
FLT Output ON Resistance	R _{FLTL}	-	30	80	Ω	I _{FLT} = 5 mA

Typical Performance Curves

(Reference data)

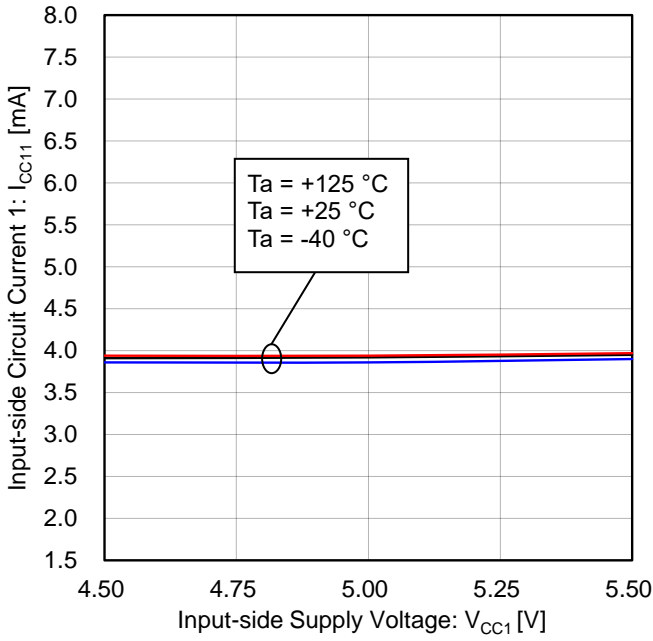

Figure 1.
Input-side Circuit Current 1
vs Input-side Supply Voltage

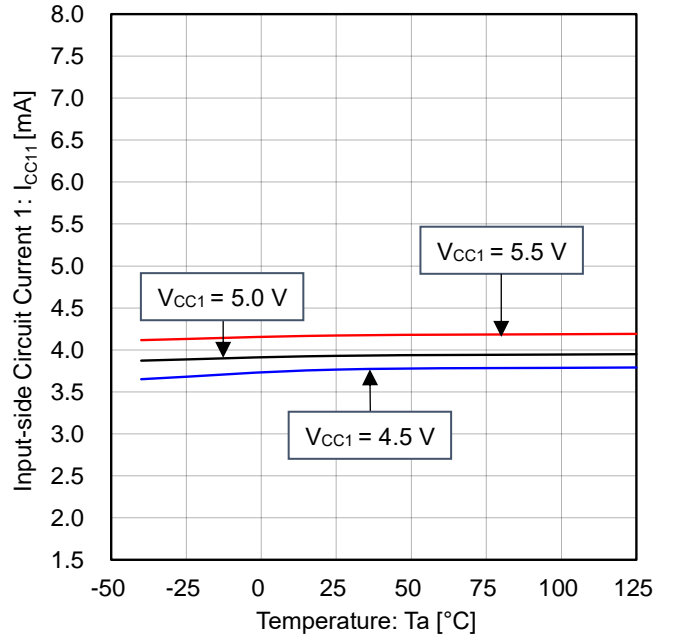

Figure 2.
Input-side Circuit Current 1 vs Temperature

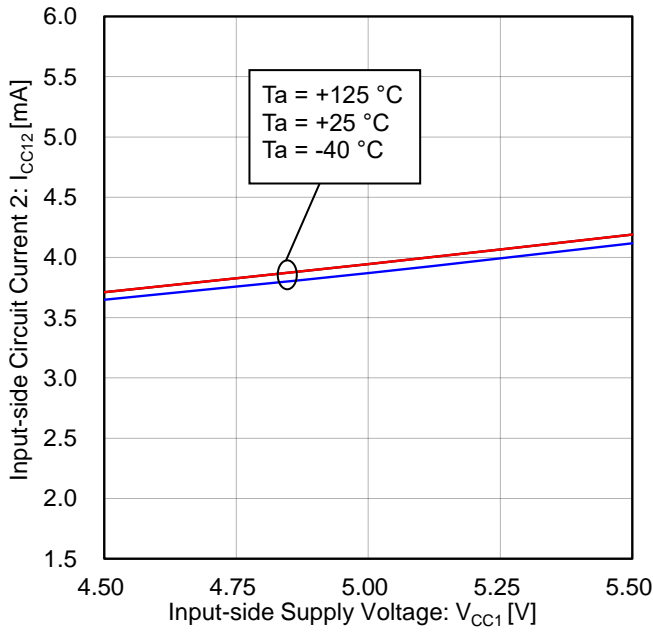

Figure 3.
Input-side Circuit Current 2
vs Input-side Supply Voltage

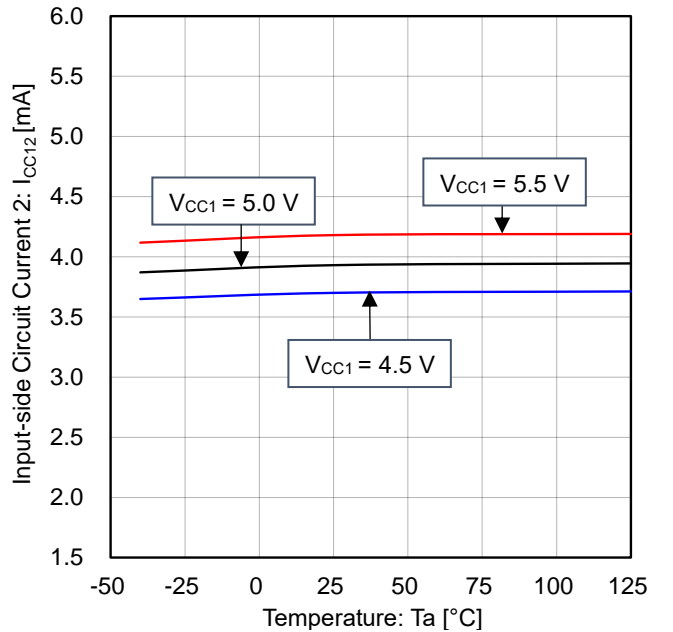

Figure 4.
Input-side Circuit Current 2 vs Temperature

Typical Performance Curves - continued

(Reference data)

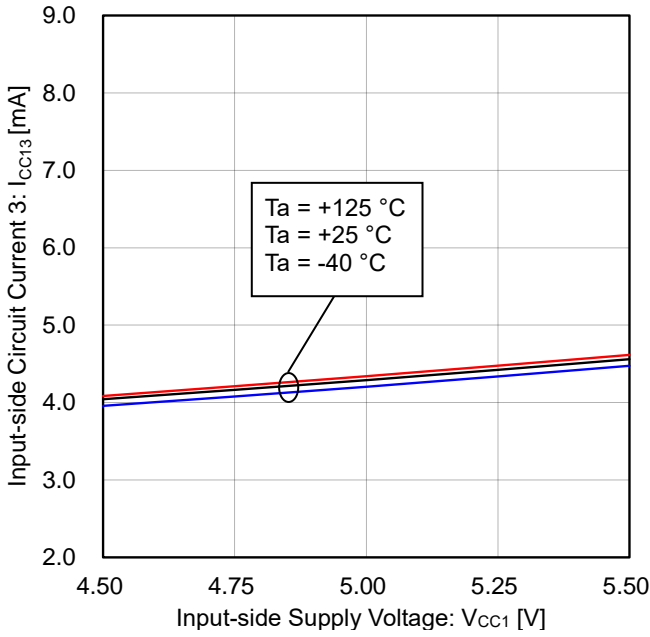

Figure 5.
Input-side Circuit Current 3
vs Input-side Supply Voltage

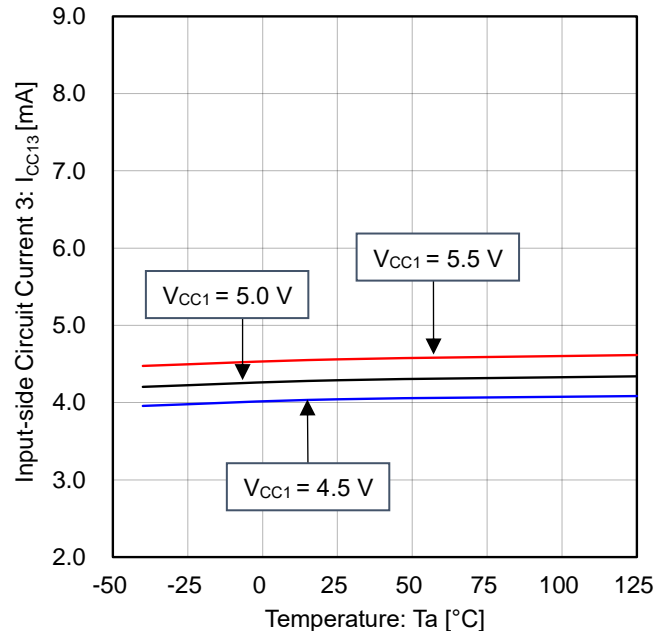

Figure 6.
Input-side Circuit Current 3 vs Temperature

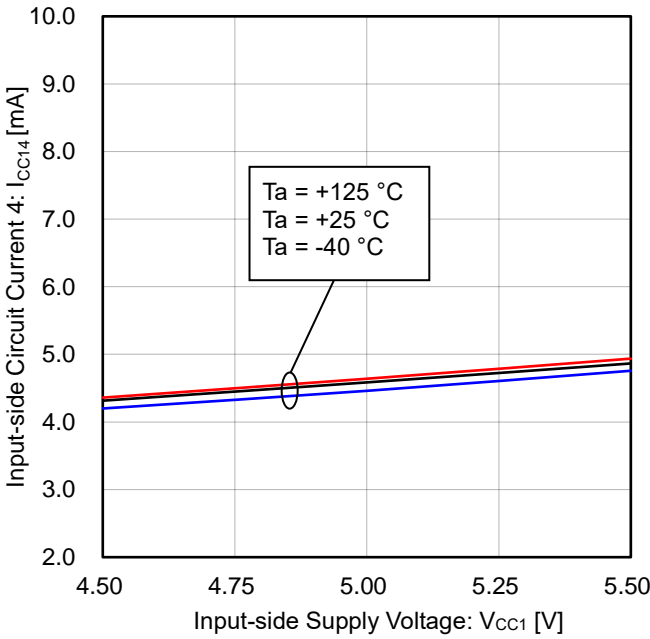

Figure 7.
Input-side Circuit Current 4
vs Input-side Supply Voltage

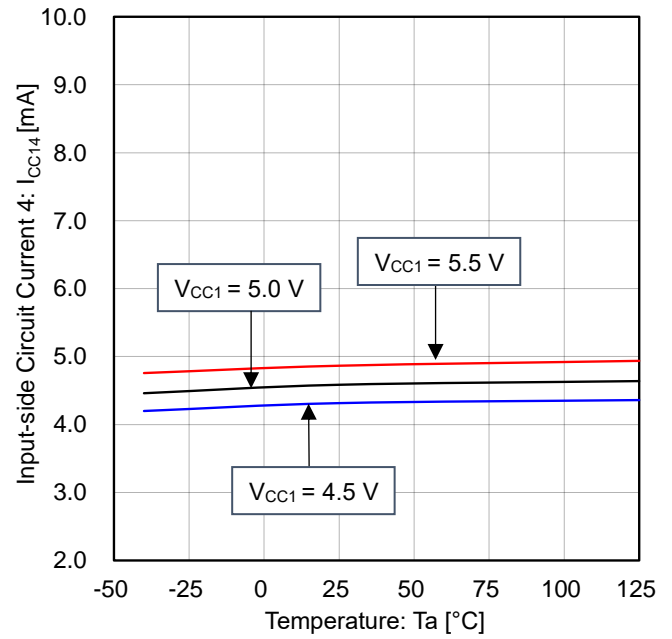

Figure 8.
Input-side Circuit Current 4 vs Temperature

Typical Performance Curves - continued

(Reference data)

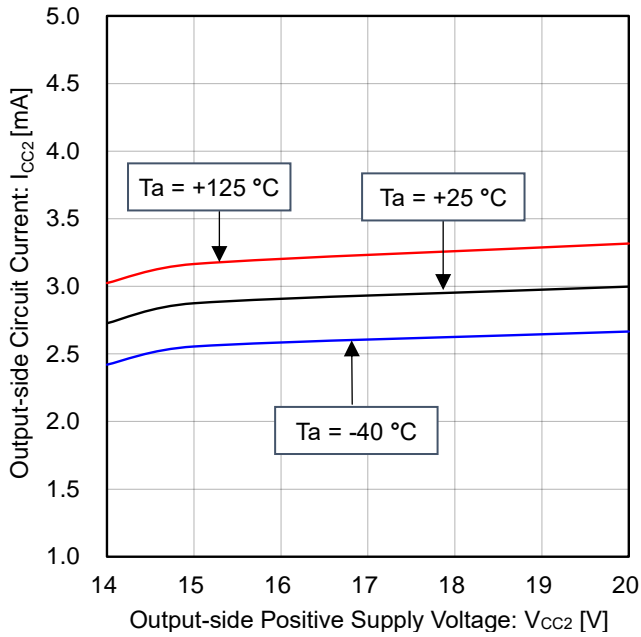

Figure 9.
Output-side Circuit Current vs
Output-side Positive Supply Voltage

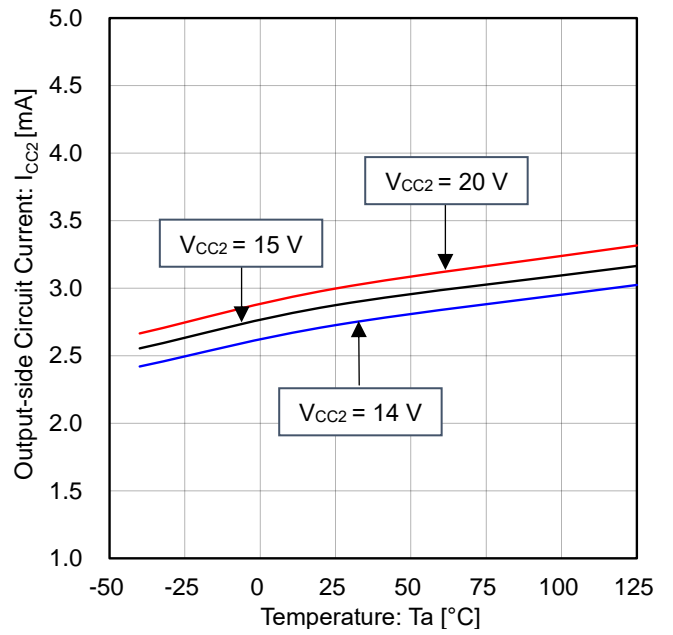

Figure 10.
Output-side Circuit Current vs Temperature

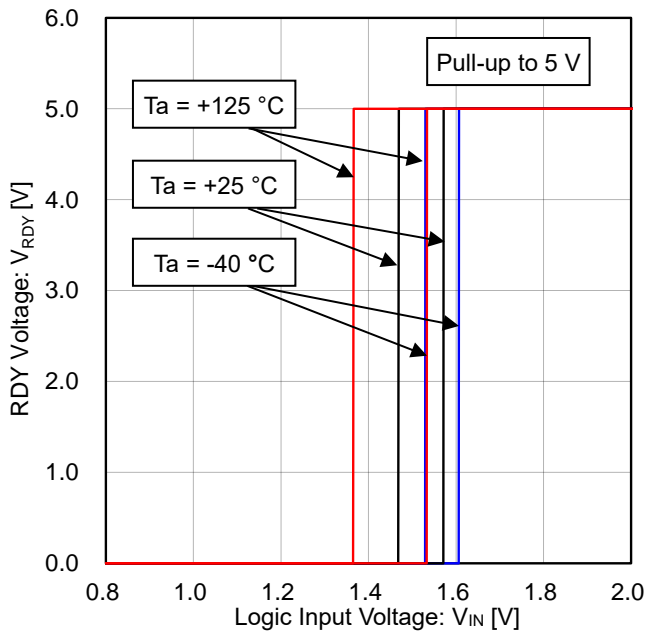

Figure 11.
RDY Voltage vs Logic Input Voltage
(Logic High/Low Level Input Voltage)

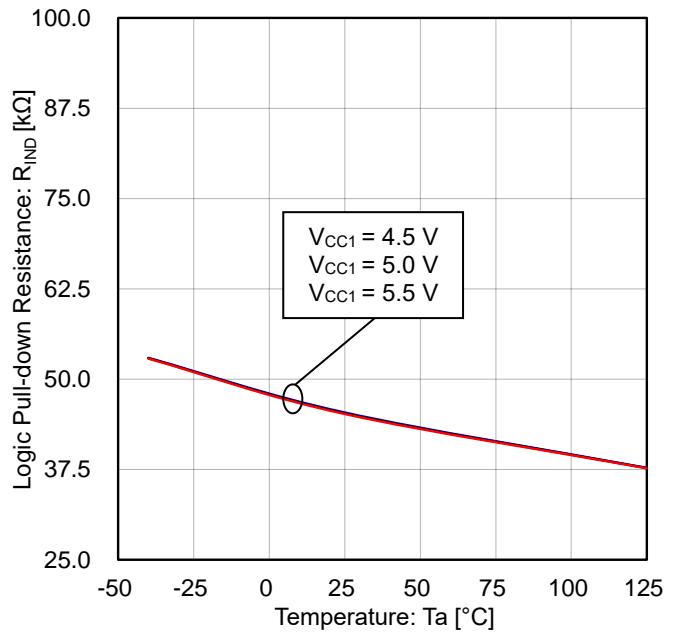

Figure 12.
Logic Pull-down Resistance vs Temperature

Typical Performance Curves - continued

(Reference data)

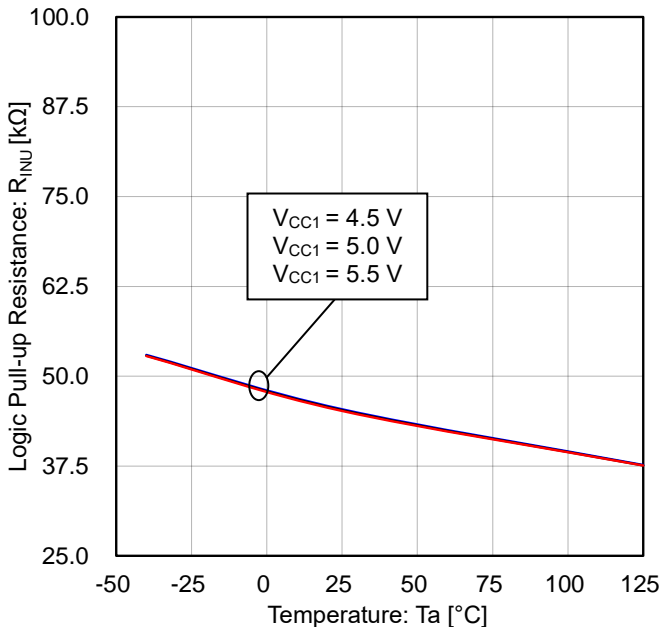

Figure 13.
Logic Pull-up Resistance vs Temperature

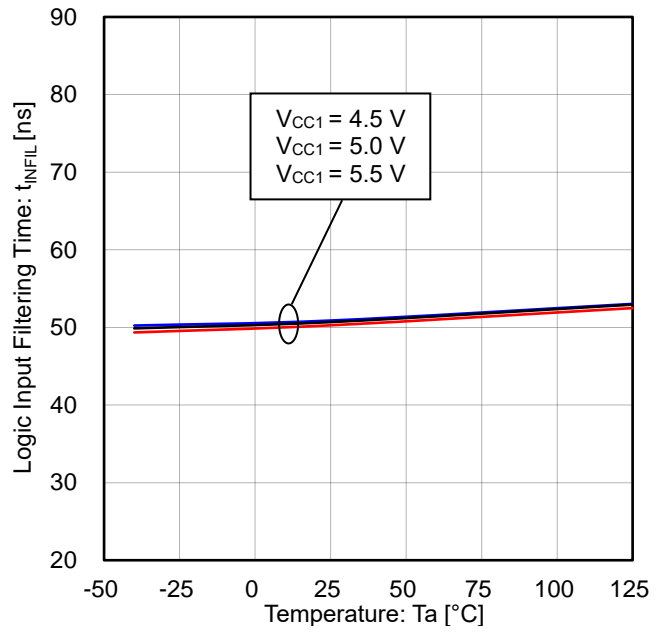

Figure 14.
Logic Input Filtering Time vs Temperature

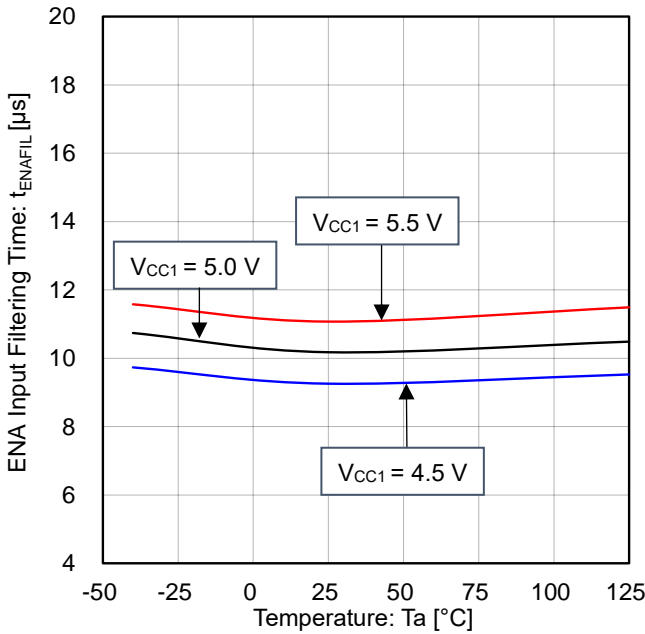

Figure 15.
ENA Input Filtering Time vs Temperature

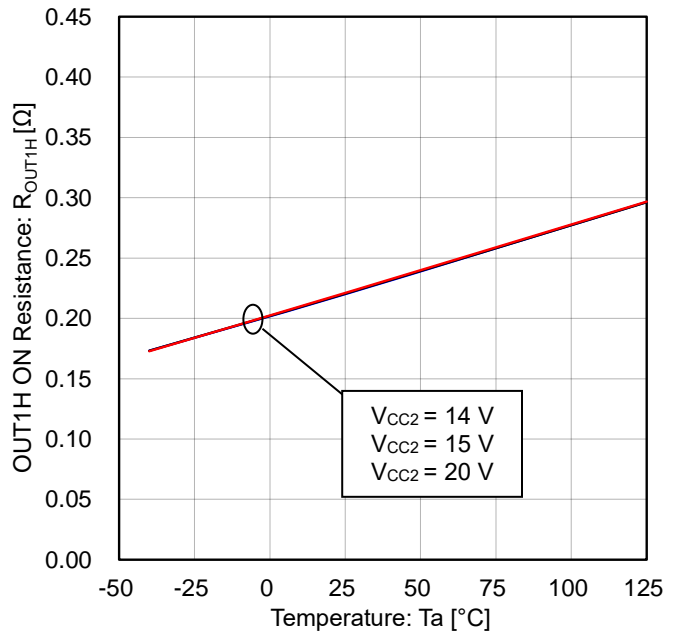

Figure 16.
OUT1H ON Resistance vs Temperature

Typical Performance Curves - continued

(Reference data)

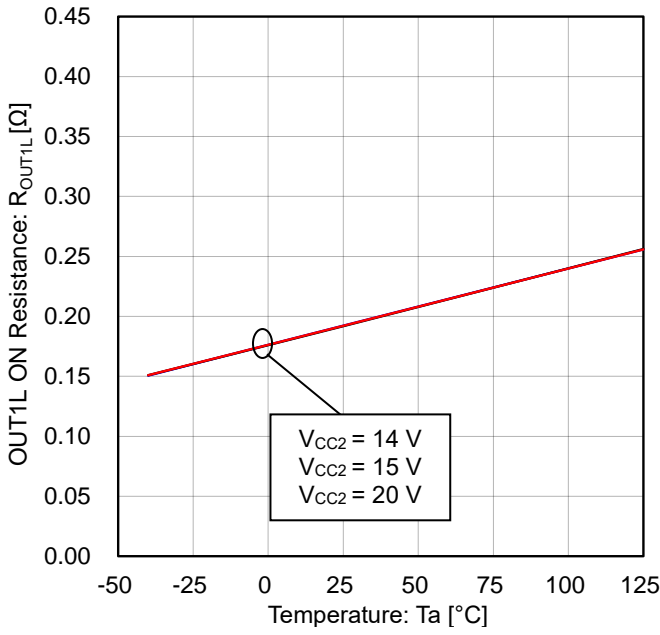

Figure 17.
OUT1L ON Resistance vs Temperature

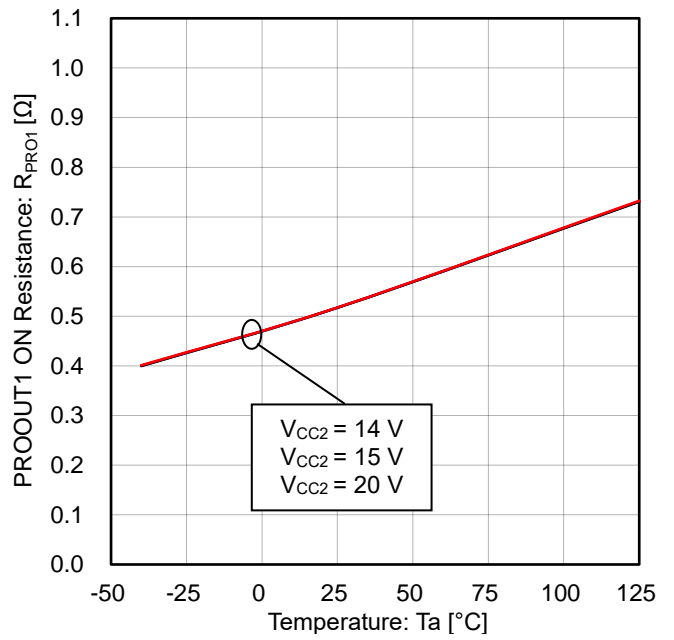

Figure 18.
PROOUT1 ON Resistance vs Temperature

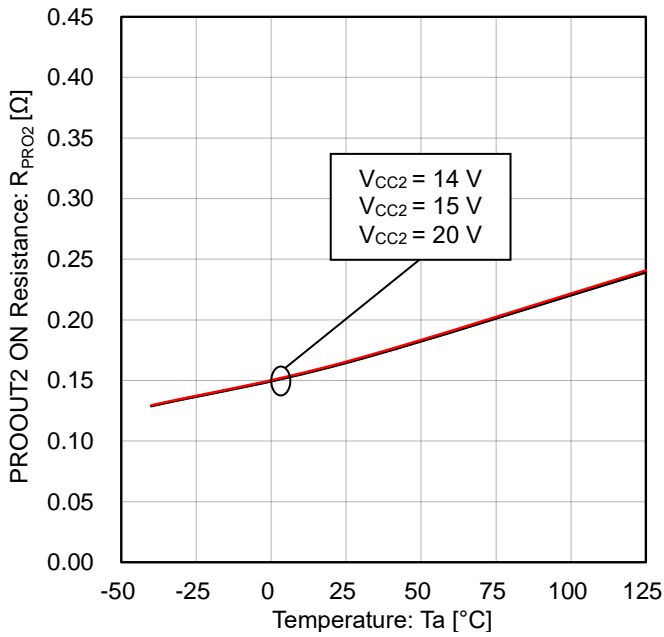

Figure 19.
PROOUT2 ON Resistance vs Temperature

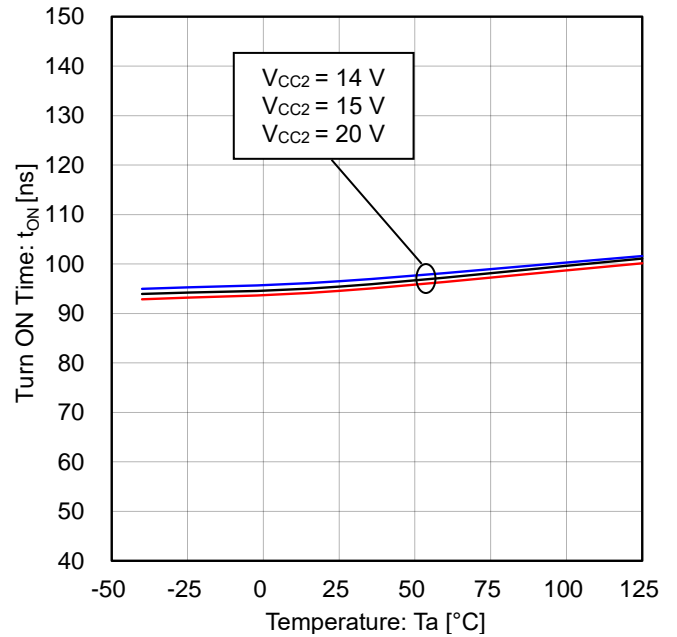

Figure 20.
Turn ON Time vs Temperature

Typical Performance Curves - continued

(Reference data)

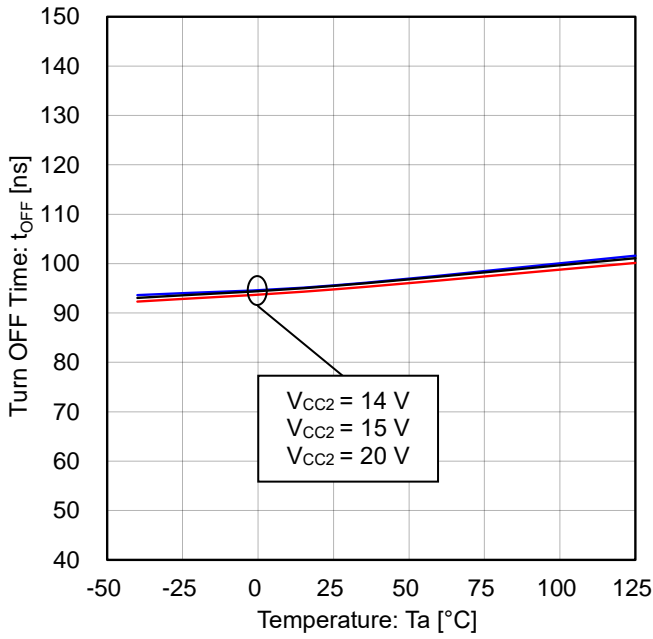

Figure 21. Turn OFF Time vs Temperature

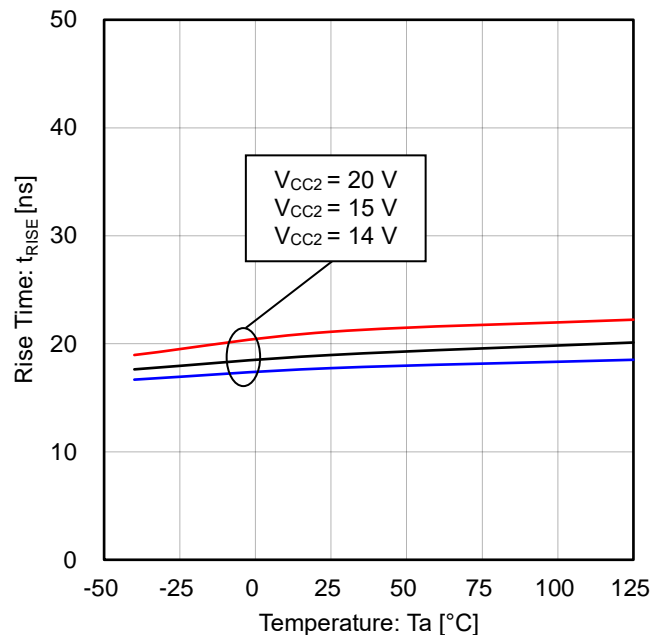

Figure 22. Rise Time vs Temperature

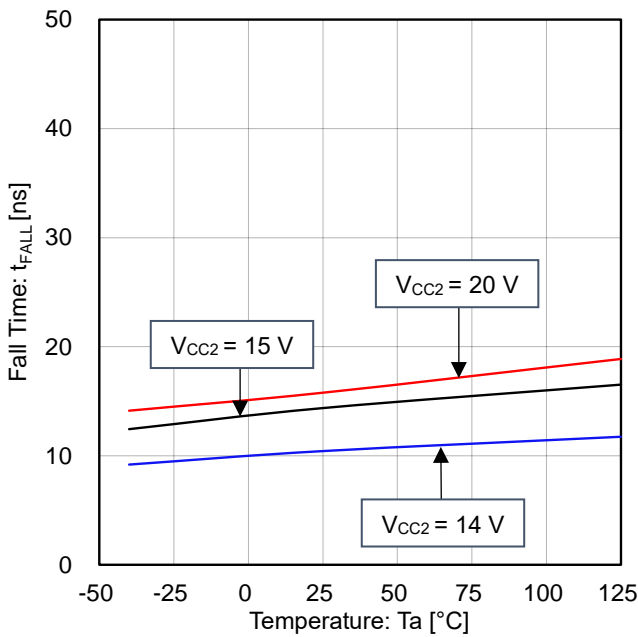

Figure 23. Fall Time vs Temperature

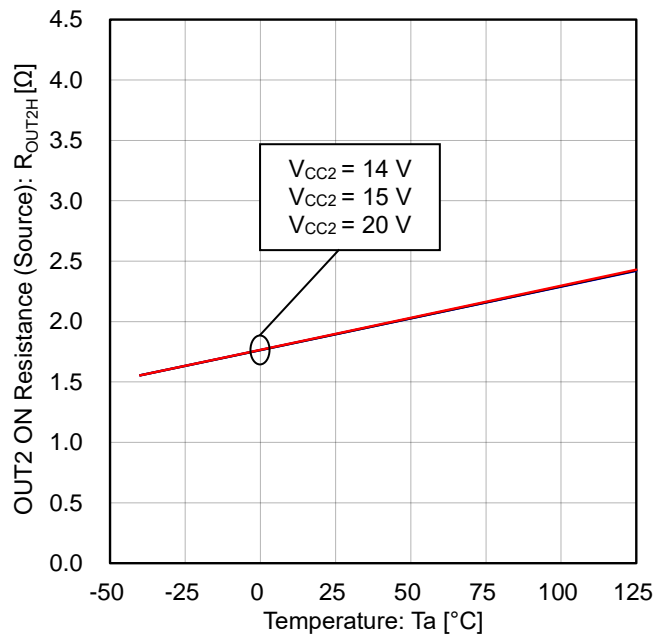

Figure 24. OUT2 ON Resistance (Source) vs Temperature

Typical Performance Curves - continued

(Reference data)

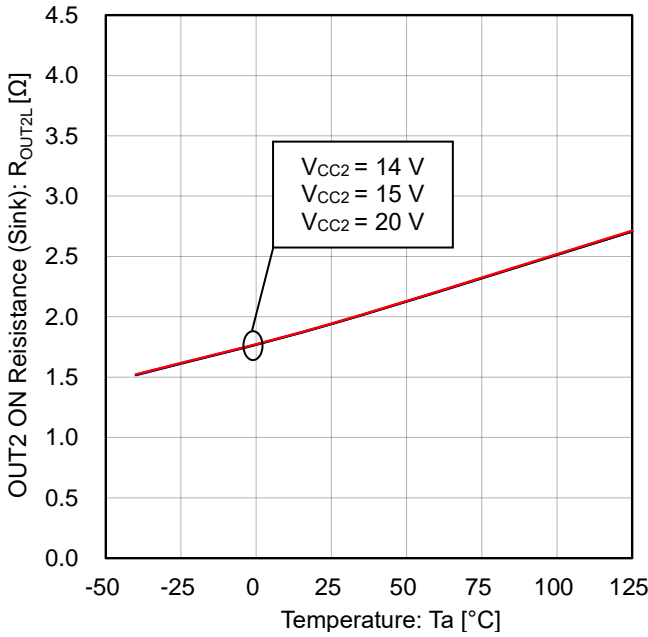

Figure 25.
OUT2 ON Resistance (Sink) vs Temperature

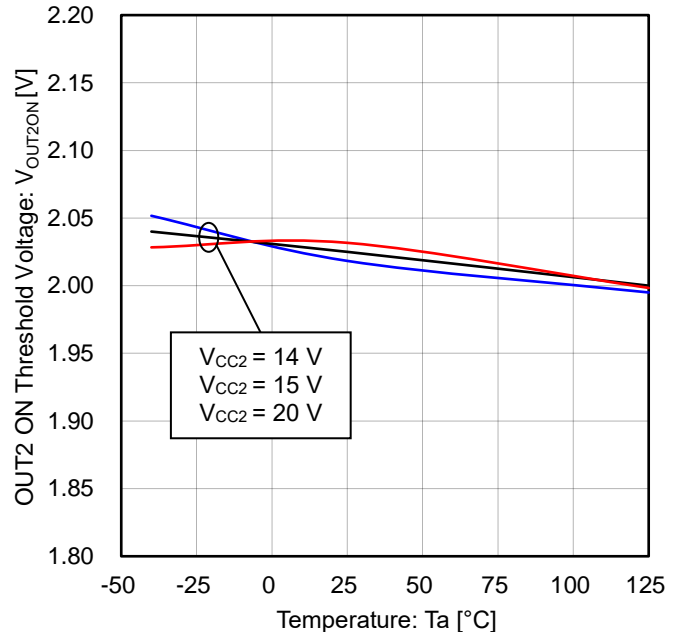

Figure 26.
OUT2 ON Threshold Voltage vs Temperature

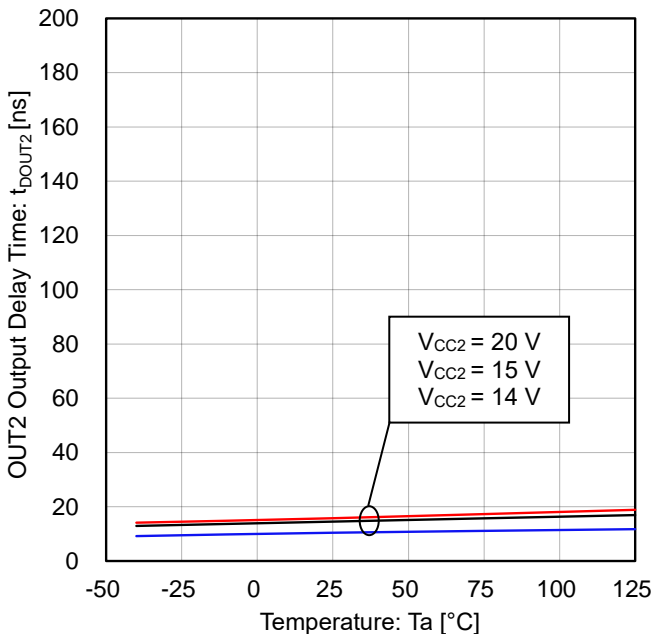

Figure 27.
OUT2 Output Delay Time vs Temperature

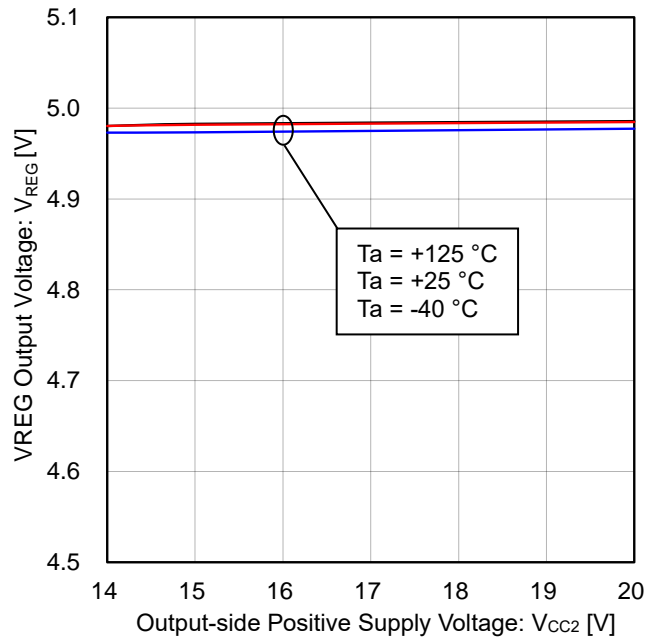

Figure 28.
VREG Output Voltage vs
Output-side Positive Supply Voltage

Typical Performance Curves - continued

(Reference data)

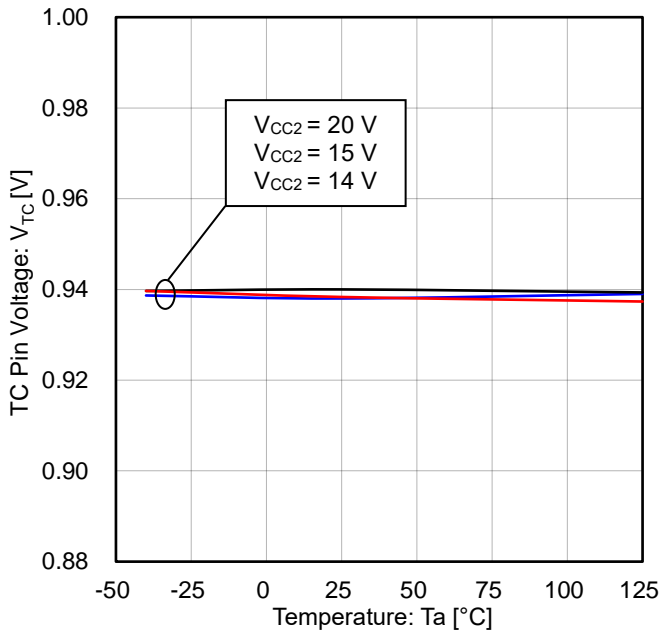

Figure 29.
TC Pin Voltage vs Temperature

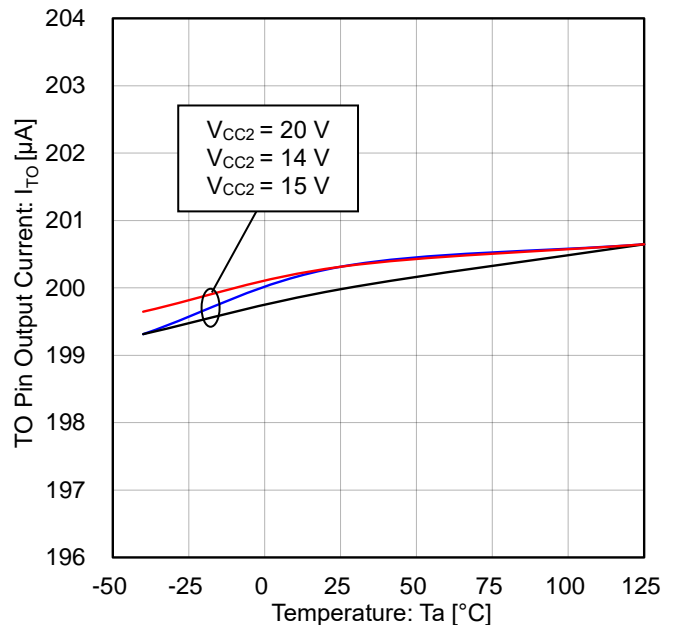

Figure 30.
TO Pin Output Current vs Temperature

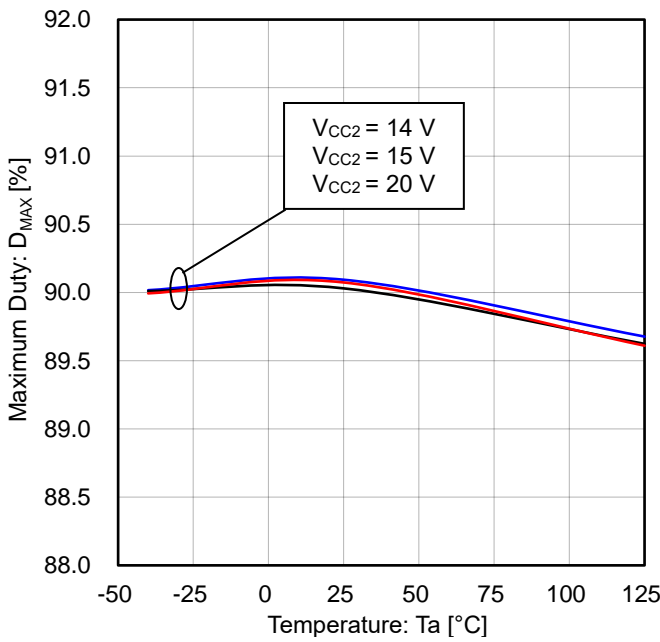

Figure 31.
Maximum Duty vs Temperature

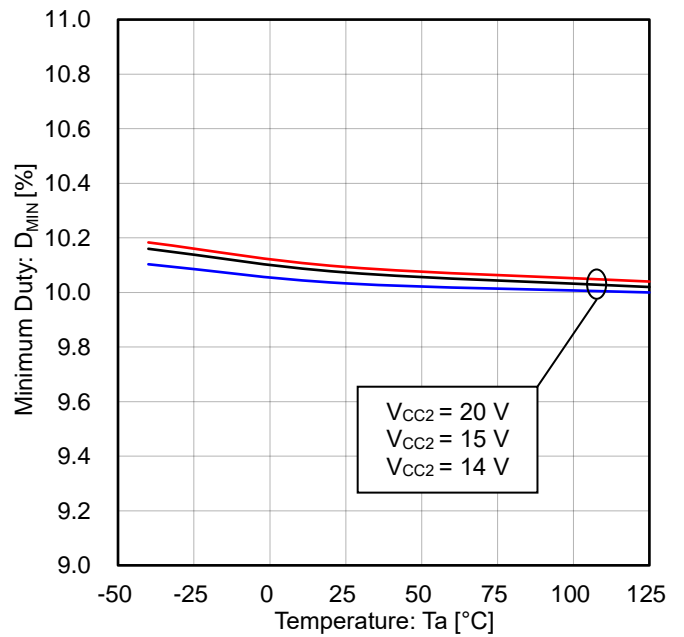

Figure 32.
Minimum Duty vs Temperature

Typical Performance Curves - continued

(Reference data)

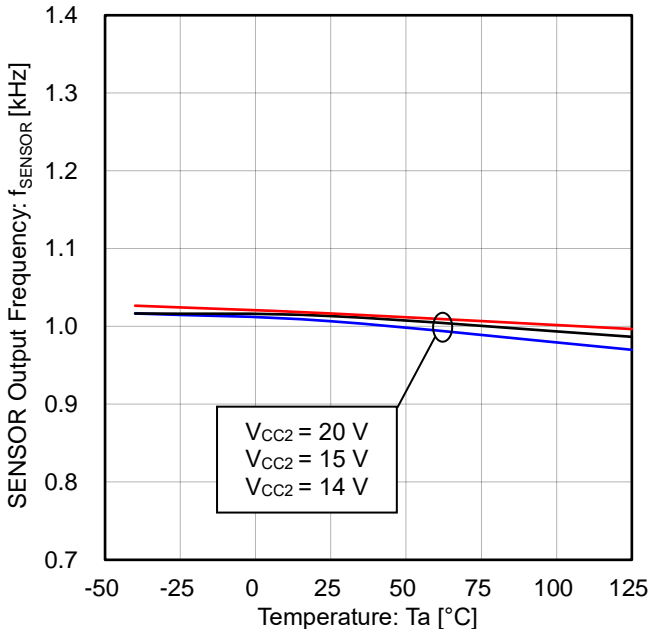

Figure 33.
SENSOR Output Frequency vs Temperature

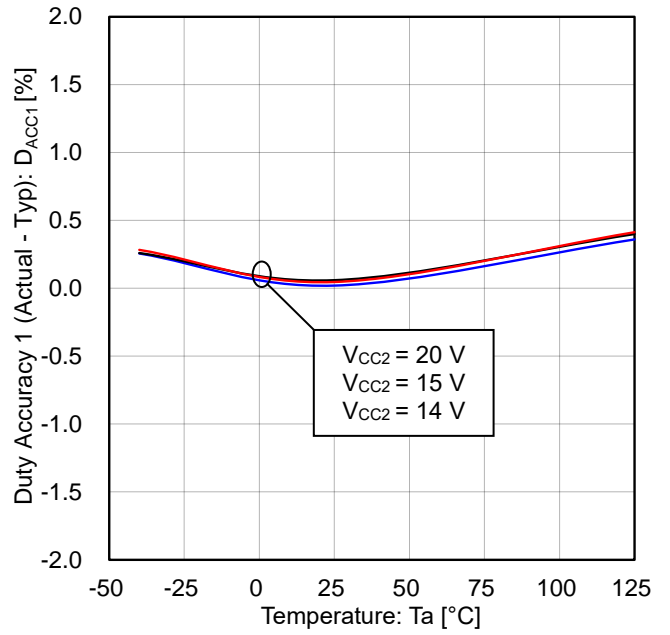

Figure 34.
Duty Accuracy 1 (Actual - Typ) vs Temperature

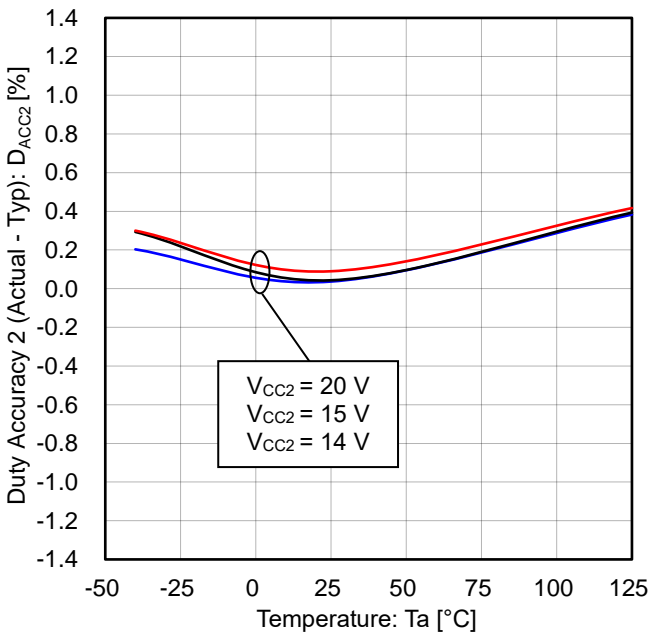

Figure 35.
Duty Accuracy 2 (Actual - Typ) vs Temperature

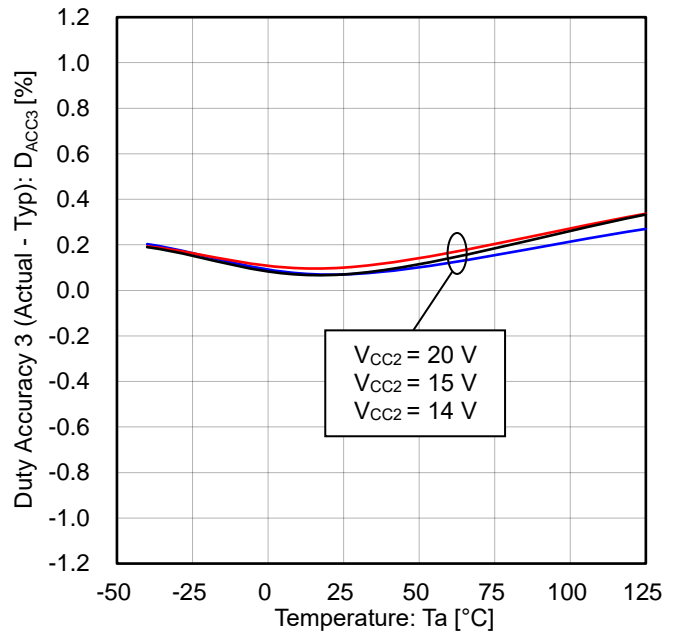

Figure 36.
Duty Accuracy 3 (Actual - Typ) vs Temperature

Typical Performance Curves - continued

(Reference data)

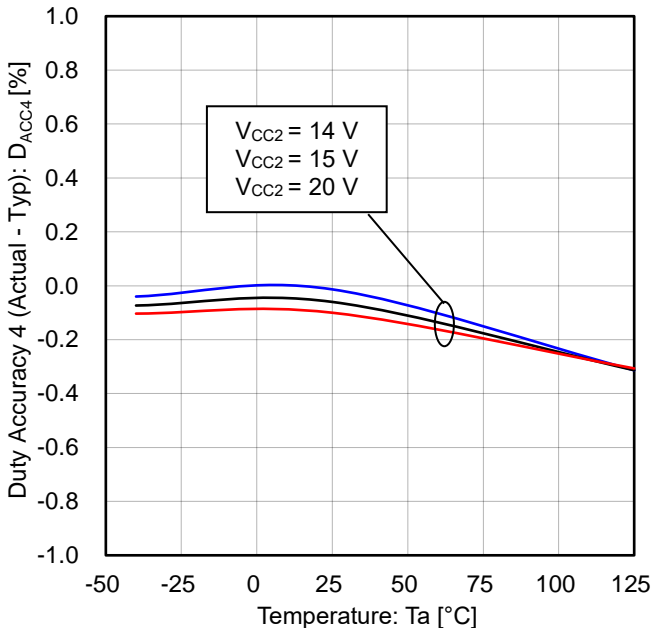

Figure 37.
Duty Accuracy 4 (Actual - Typ) vs Temperature

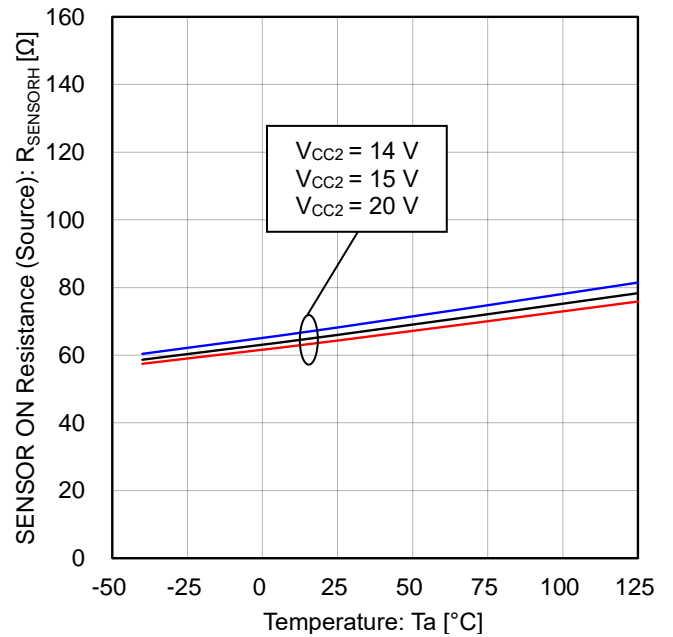

Figure 38.
SENSOR ON Resistance (Source) vs Temperature

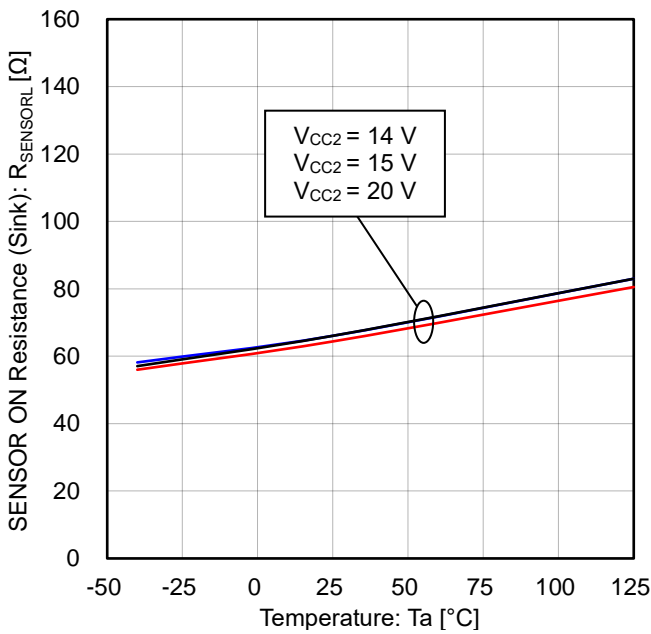

Figure 39.
SENSOR ON Resistance (Sink) vs Temperature

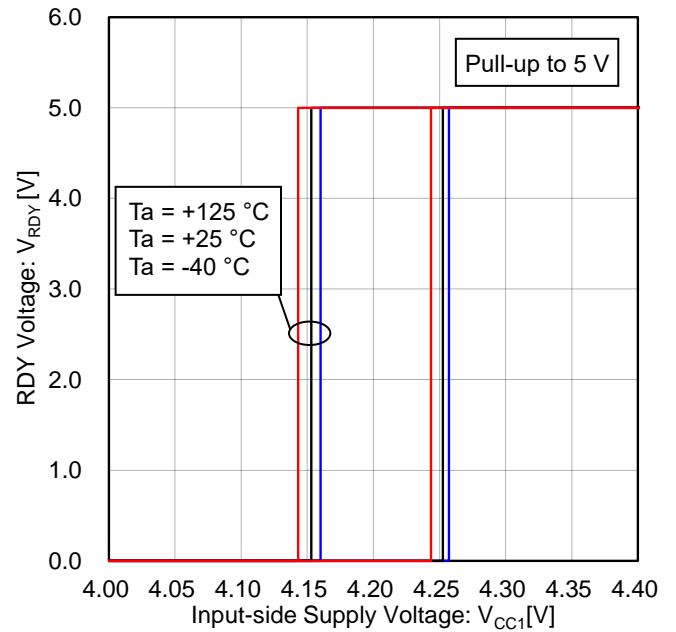

Figure 40.
RDY Voltage vs Input-side Supply Voltage
(Input-side UVLO ON/OFF Voltage)

Typical Performance Curves - continued

(Reference data)

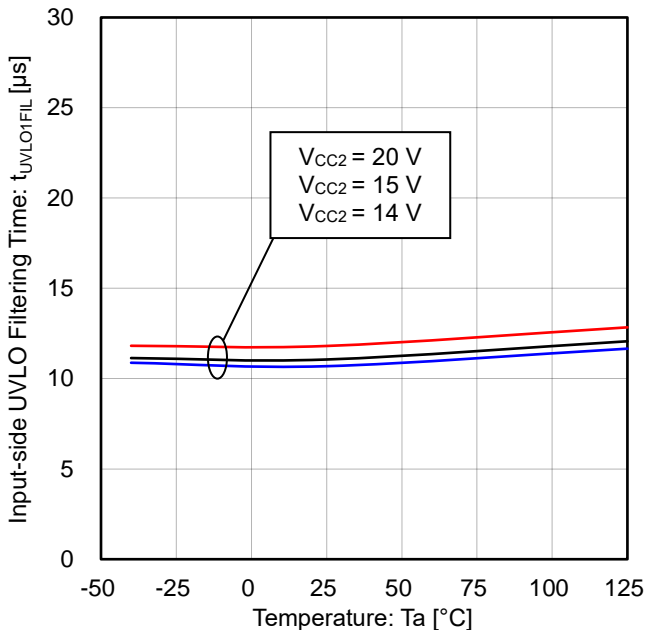

Figure 41.
Input-side UVLO Filtering Time vs Temperature

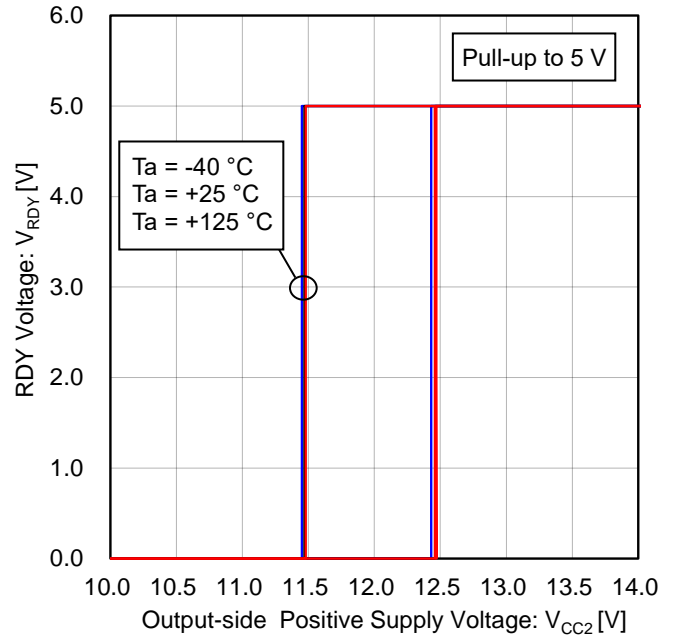

Figure 42.
RDY Voltage vs Output-side Positive Supply Voltage
(Output-side UVLO ON/OFF Voltage)

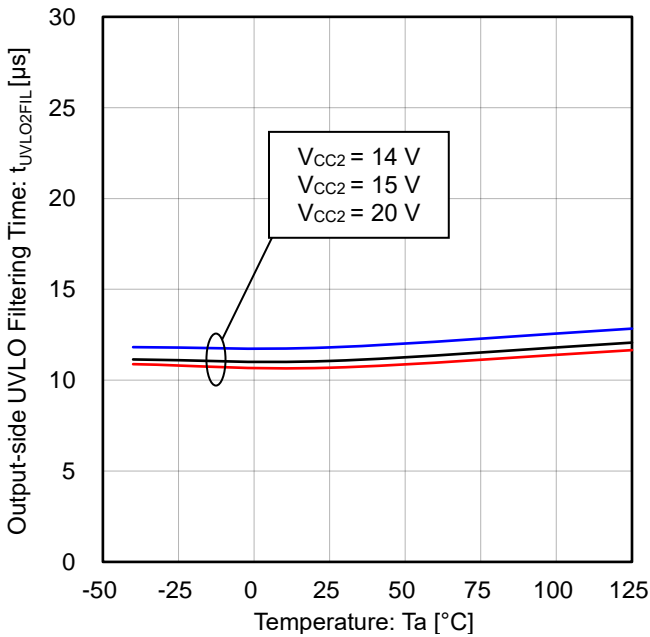

Figure 43.
Output-side UVLO Filtering Time vs Temperature

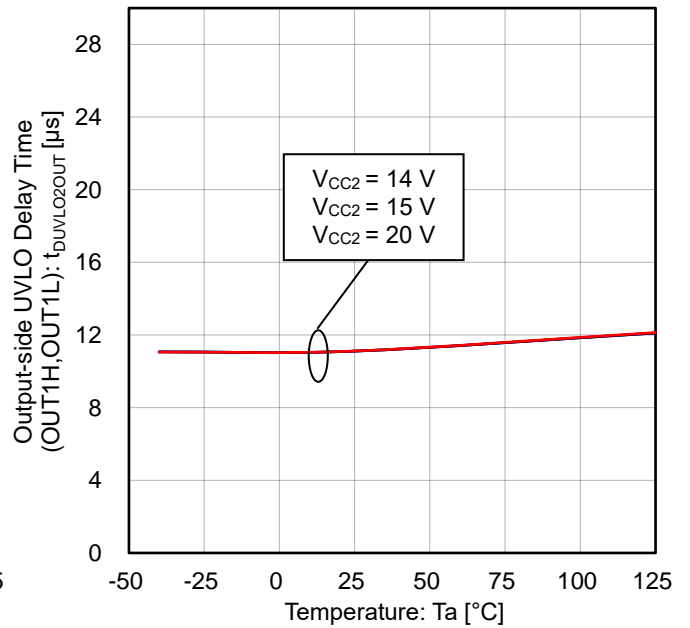

Figure 44.
Output-side UVLO Delay Time (OUT1H, OUT1L)
vs Temperature

Typical Performance Curves - continued

(Reference data)

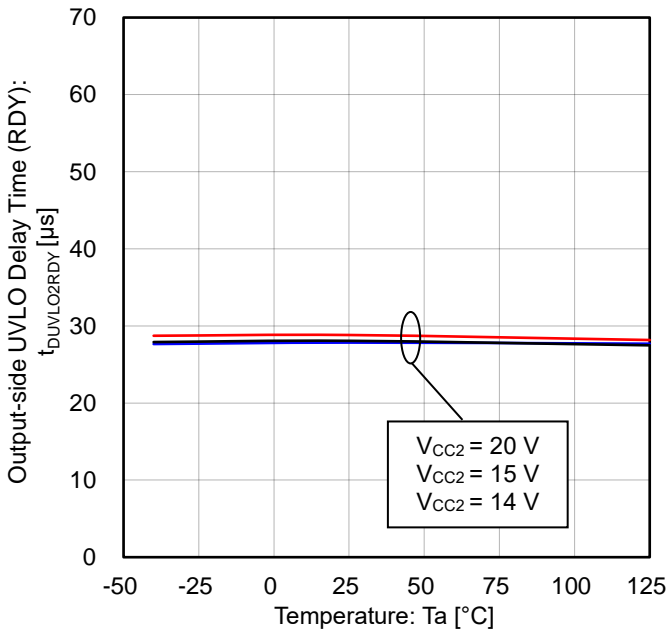

Figure 45.
Output-side UVLO Delay Time (RDY)
vs Temperature

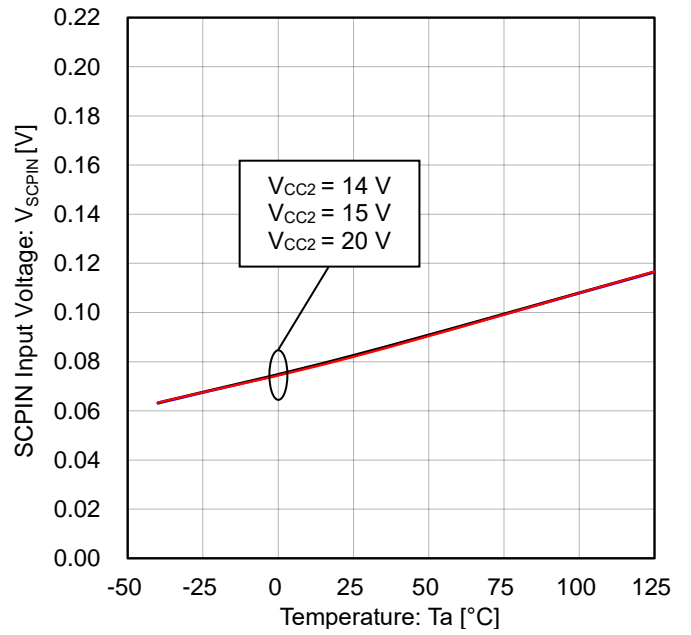

Figure 46.
SCPIN Input Voltage vs Temperature

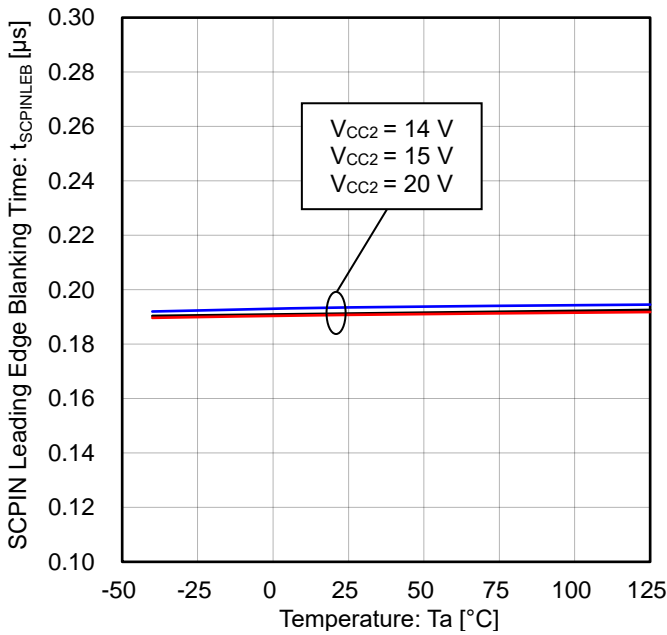

Figure 47.
SCPIN Leading Edge Blanking Time vs Temperature

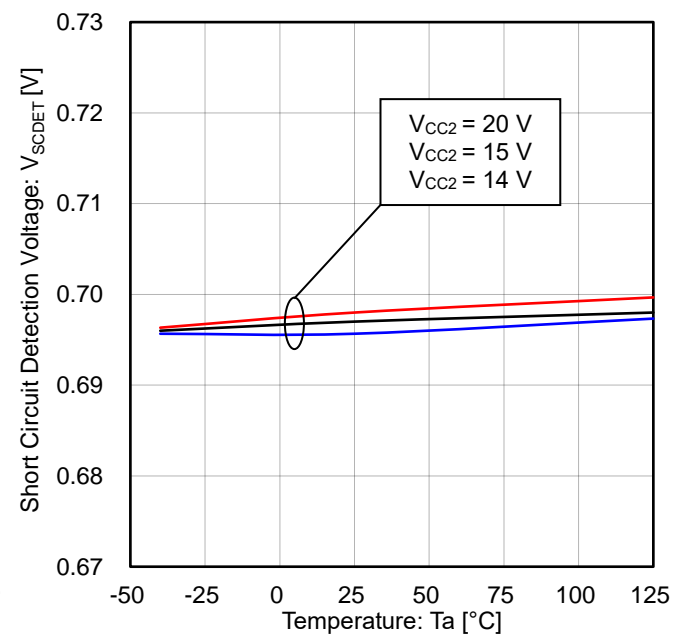

Figure 48.
Short Circuit Detection Voltage vs Temperature

Typical Performance Curves - continued

(Reference data)

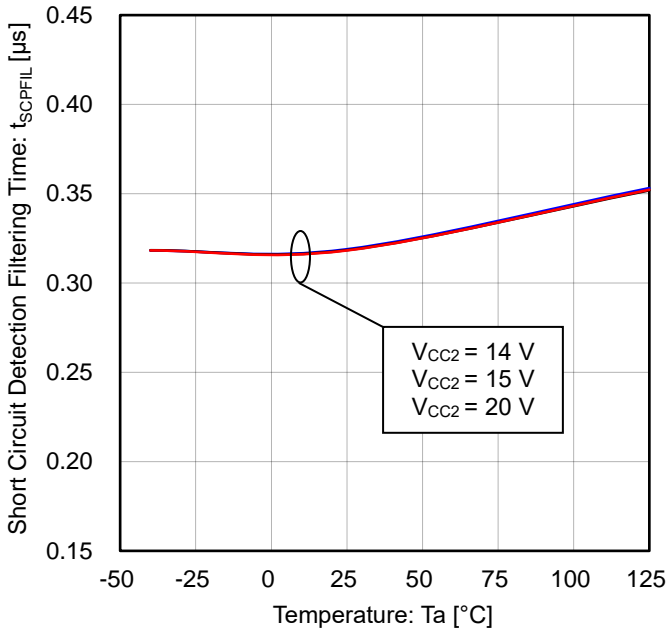

Figure 49.
Short Circuit Detection Filtering Time vs Temperature

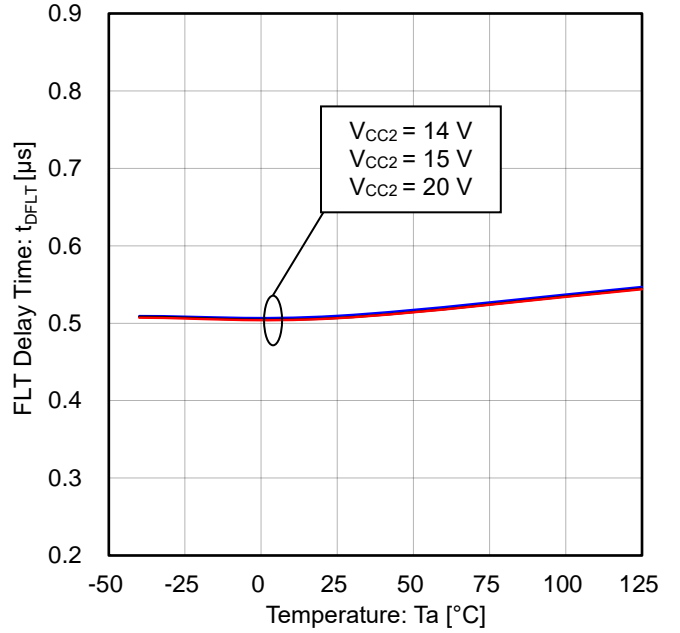

Figure 50.
FLT Delay Time vs Temperature

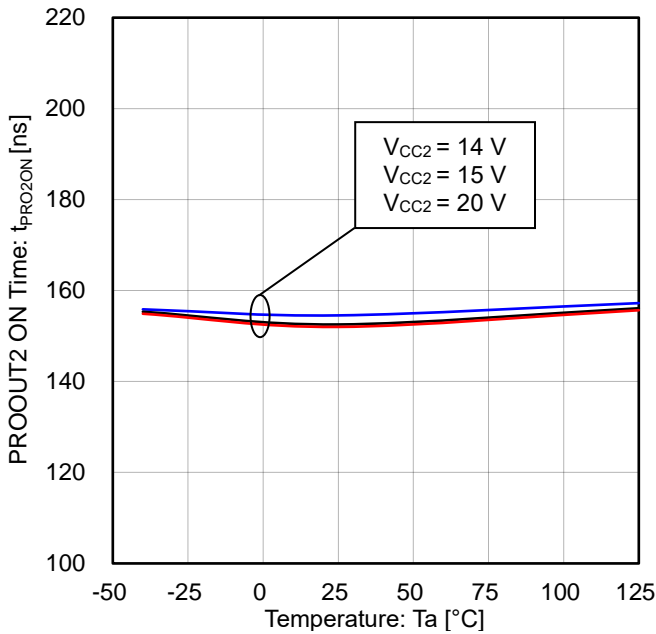

Figure 51.
PROOUT2 ON Time vs Temperature

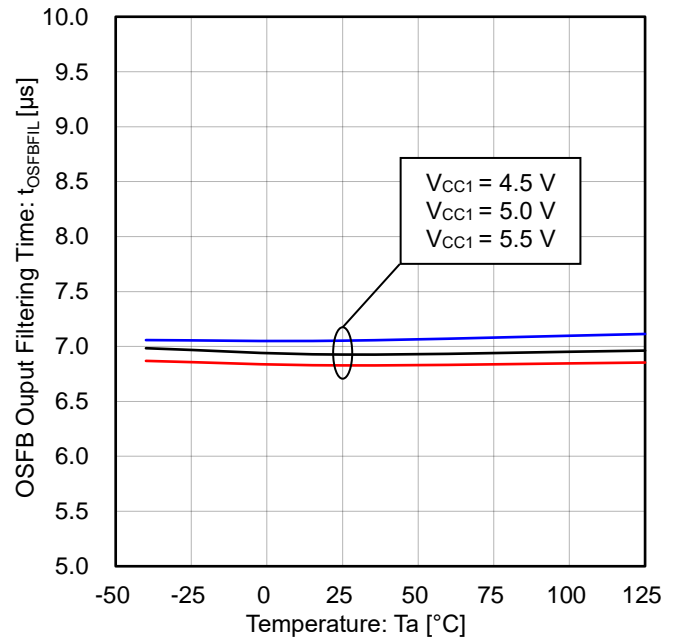

Figure 52.
OSFB Output Filtering Time vs Temperature

Typical Performance Curves - continued
(Reference data)

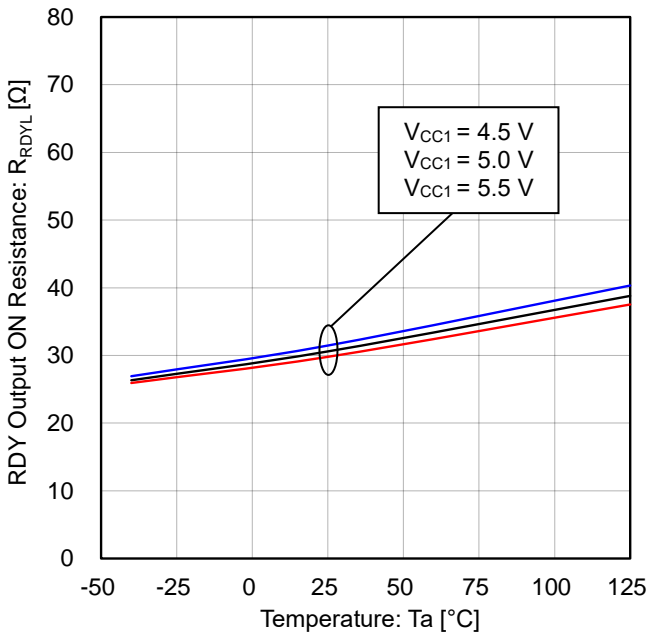

Figure 53.
RDY Output ON Resistance vs Temperature

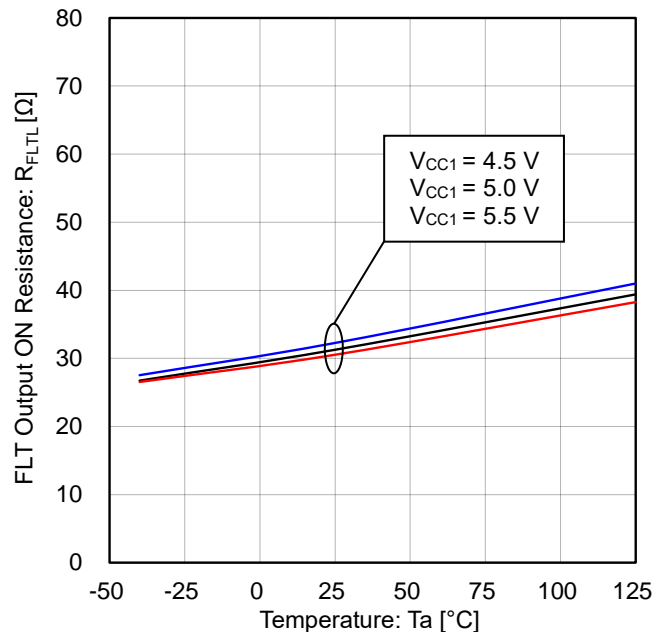

Figure 54.
FLT Output ON Resistance vs Temperature

Application Information

1. Description of Pins and Cautions on Layout of Board

- (1) VCC1 (Input-side power supply pin)
The VCC1 pin is a power supply pin on the input side. To suppress voltage fluctuations due to the driving current of the internal transformer, connect a bypass capacitor between the VCC1 and GND1 pins.
- (2) GND1 (Input-side ground pin)
The GND1 pin is a ground pin on the input side.
- (3) VCC2 (Output-side positive power supply pin)
The VCC2 pin is a positive power supply pin on the output side. To suppress voltage fluctuations due to the OUT1H pin or the OUT1L pin output current and due to the driving current of the internal transformer and output current, connect a bypass capacitor between the VCC2 and GND2 pins.
- (4) VEE2 (Output-side negative power supply pin)
The VEE2 pin is a negative power supply pin on the output side. To suppress voltage fluctuations due to the OUT1H pin or the OUT1L pin output current and due to the driving current of the internal transformer and output current, connect a bypass capacitor between the VEE2 and GND2 pins. Connect the VEE2 pin to the GND2 pin when no negative power supply is used.
- (5) GND2 (Output-side ground pin)
The GND2 pin is a ground pin on the output side. Connect the GND2 pin to the emitter or source of output device.

- (6) INA, INB, ENA (Control input pin)
The INA, INB, and ENA pins are pins used to determine output logic.

ENA	INB	INA	OUT1H	OUT1L
L	Don't care	Don't care	Hi-Z	L
H	H	Don't care	Hi-Z	L
H	L	L	Hi-Z	L
H	L	H	H	Hi-Z

- (7) FLT (Fault output pin)
The FLT pin is an open drain pin used to output a fault signal when short circuit protection (SCP) function is activated, and will be released at the rising edge of the ENA.

State	FLT
While in normal operation	Hi-Z
When a Fault occurs (SCP)	L

- (8) RDY (Ready output pin)
The RDY pin shows the status of three internal protection features which are VCC1 UVLO, VCC2 UVLO and output state feedback (OSFB). The term "output state feedback" shows whether the PROOUT1 pin voltage (High or Low) corresponds to input logic or not.

Status	RDY
While in normal operation	Hi-Z
VCC1 UVLO or VCC2 UVLO or Output state feedback	L

- (9) SENSOR (Temperature information output pin)
This is a pin which outputs the voltage of the TO pin converted to Duty cycle.
- (10) OUT1H, OUT1L (Source-side, Sink-side output pin)
The OUT1H pin is a source side pin used to drive the gate of a power device. The OUT1L pin is a sink side pin used to drive the gate of a power device. The OUT1H pin is also used to monitor gate voltage for active miller clamping function.
- (11) OUT2 (Gate control pin for active miller clamping)
The OUT2 pin is a pin used for controlling the external MOSFET to prevent an increase in gate voltage due to the miller current of the power device connected to the OUT1H pin or the OUT1L pin.
- (12) VREG (Power supply pin for driving MOSFET for active miller clamping)
The VREG pin is a power supply pin for active miller clamping (Typ 5 V). Be sure to connect a capacitor between the VREG pin and the VEE2 pin to prevent oscillation and to suppress voltage fluctuations due to the OUT2 pin output current.

Description of Pins and Cautions on Layout of Board – continued

- (13) PROOUT1, PROOUT2 (Soft turn-off pin / Gate voltage input pin)
 These are pins for soft turn off of the gate of the power device when short circuit protection is activated. Both the PROOUT1 pin and the PROOUT2 pin turn on for t_{PRO2ON} (Typ 160 ns) from short circuit detection. After t_{PRO2ON} (Typ 160 ns), only the PROOUT1 pin continues to turn on. The PROOUT1 pin is also used to monitor gate voltage for output state feedback function.
- (14) SCPIN1, SCPIN2 (Short circuit current detection pin)
 The SCPIN1 pin and the SCPIN2 pin are pins used to detect current for short-current protection. When the SCPIN1 pin or the SCPIN2 pin voltage exceeds V_{SCDET} (Typ 0.7 V), SCP function will be activated. This may cause the IC to malfunction in an open state. To avoid such trouble, connect the SCPIN1 pin or the SCPIN2 pin to the GND2 pin respectively if either of which is not used. In order to prevent the wrong detection due to noise, the noise mask time t_{SCPFIL} (Typ 0.3 μ s) is set.
- (15) TC (Resistor connection pin for setting constant current source output)
 The TC pin is a resistor connection pin for setting the constant current output. If an arbitrary resistance value is connected between the TC pin and the VEE2 pin, it is possible to set the constant current value output from the TO pin.
- (16) TO (Constant current output pin / Sensor voltage input pin)
 The TO pin is constant current output or voltage input pin. It can be used as a sensor input by connecting an element with arbitrary impedance between the TO pin and the GND2 pin.

2. Description of Functions and Examples of Constant Setting

- (1) Active Miller Clamping Function
 When OUT1H Hi-Z and the OUT1H pin voltage $< V_{OUT2ON}$ (Typ 2 V), the OUT2 pin outputs High signal and the external MOSFET is turned ON. Once OUT2 is turned High, OUT2 remains High even if OUT1H exceeds V_{OUT2ON} (Typ 2 V). When OUT1H = High, the OUT2 pin outputs Low signal and the external MOSFET is turned OFF.

OUT1H	OUT2
Hi-Z (Not less than V_{OUT2ON})	L
Hi-Z (less than V_{OUT2ON})	H
H	L

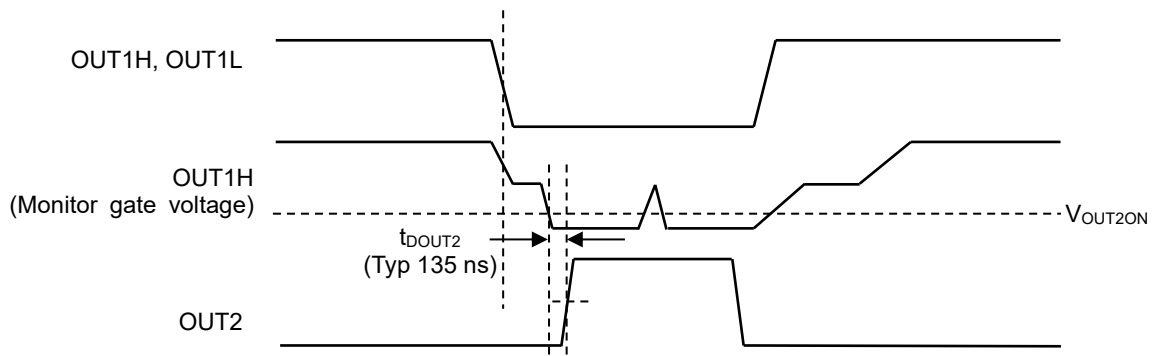

Figure 55. Timing Chart of Active Miller clamping

- (2) Fault Status Output Function
 This function is used to output a fault signal from the FLT pin when short-circuit protection is activated and hold the Fault signal until rising edge of the ENA is put in.

Description of Functions and Examples of Constant Setting – continued

(3) Under Voltage Lockout (UVLO) Function

BM6112HFV-C incorporates under voltage lockout (UVLO) function both on the input and the output sides. When the power supply voltage drops to UVLO ON voltage, the OUT1L pin and the RDY pin will output a “L” signal. When the power supply voltage rises to UVLO OFF voltage, these pins will be reset. To prevent malfunctions due to noise, Filtering time $t_{UVLO1FIL}$ and $t_{UVLO2FIL}$ are set on both input and output sides.

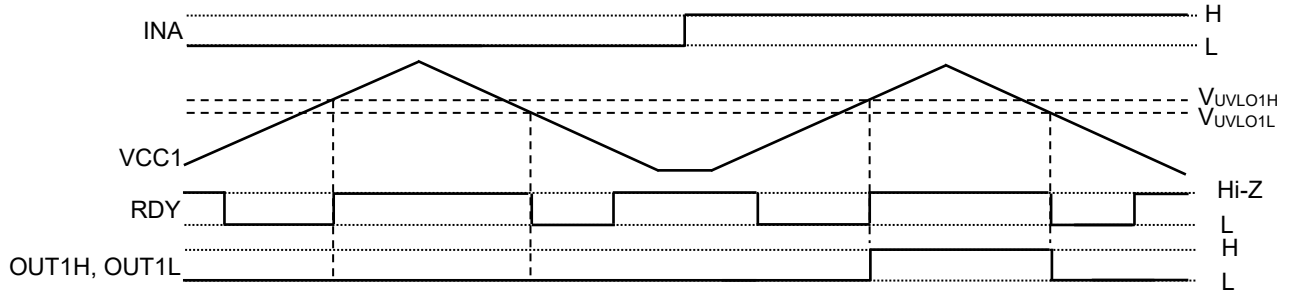

Figure 56. Input-side UVLO Function Operation Timing Chart

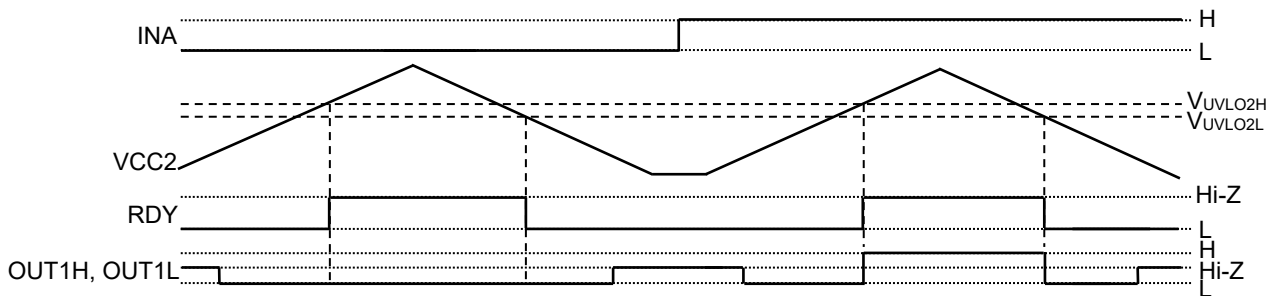

Figure 57. Output-side UVLO Operation Timing Chart

(4) Short Circuit Protection (SCP) Function

When the SCPIN1 pin voltage or the SCPIN2 pin voltage exceeds a voltage set with V_{SCDET} (Typ 0.7 V) parameter, SCP function will be activated. When SCP function is activated, the OUT1H pin and the OUT1L pin voltage will be set to “Hi-Z” level, and both the PROOUT1 pin and the PROOUT2 pin turn on for t_{PRO2ON} (Typ 160 ns). After t_{PRO2ON} (Typ 160 ns), only the PROOUT1 pin continues to turn on. First, the PROOUT1 pin voltage and the PROOUT2 pin voltage will go to the “L” level (soft turn-off). Next, when the OUT1H pin voltage $< V_{OUT2ON}$ (Typ 2 V), the OUT1H pin and the OUT1L pin become L and the PROOUT1 pin become Hi-Z. Finally, SCP function will be released at the rising edge of the ENA.

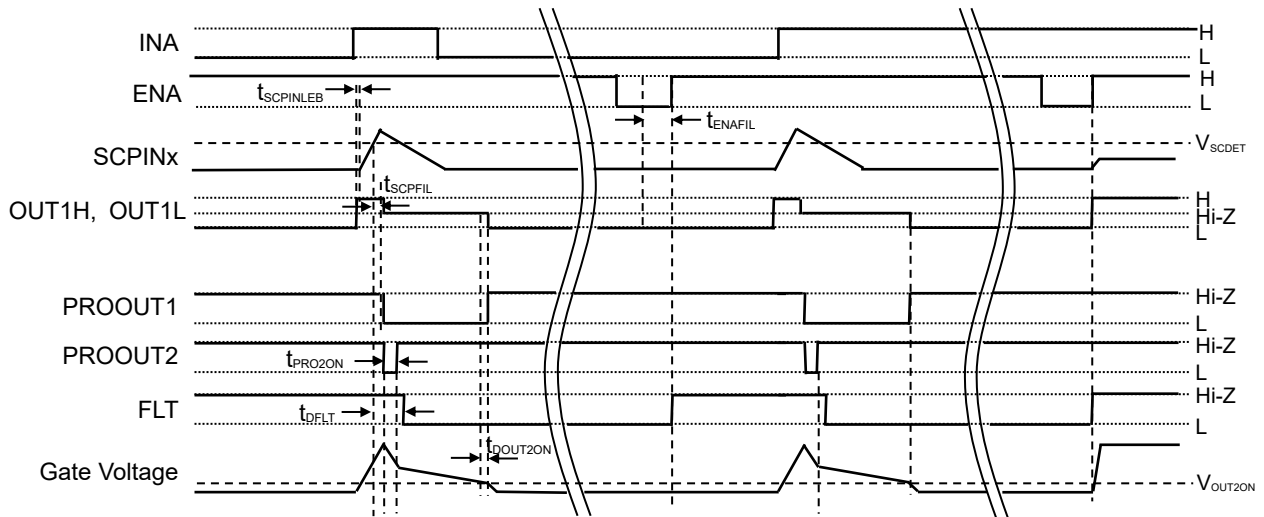

Figure 58. SCP Operation Timing Chart

Short Circuit Protection (SCP) Function – continued

Collector or drain voltage (V_{DESAT}) at which desaturation protection function operates and the blanking time (t_{BLANK}) determined by external component can be calculated by the formula below.

$$V_{DESAT} = V_{SCDET} \times \frac{R3 + R2}{R3} - V_{FD1} \quad [V]$$

$$V_{CC2MIN} > V_{SCDET} \times \frac{R3 + R2 + R1}{R3} \quad [V]$$

$$t_{BLANK} = -\frac{R2 + R1}{R3 + R2 + R1} \times R3 \times (C_{BLANK} + 6.5 \times 10^{-12}) \times \ln\left(1 - \frac{R3 + R2 + R1}{R3} \times \frac{V_{SCDET}}{V_{CC2}}\right) \quad [s]$$

where:

V_{DESAT} is the collector or drain voltage at which desaturation protection function operates.

V_{FD1} is the forward voltage of the diode.

V_{SCDET} is the Short Circuit Detection Voltage.

V_{CC2MIN} is the minimum Output-side Positive Supply Voltage.

t_{BLANK} is the blanking time.

$R1$ is the resistance 1 to determine the V_{DESAT} , V_{CC2MIN} and t_{BLANK} .

$R2$ is the resistance 2 to determine the V_{DESAT} , V_{CC2MIN} and t_{BLANK} .

$R3$ is the resistance 3 to determine the V_{DESAT} , V_{CC2MIN} and t_{BLANK} .

C_{BLANK} is the capacitance to determine the t_{BLANK} .

V_{DESAT}	Reference Value		
	R1	R2	R3
4.0 V	15 kΩ	39 kΩ	6.8 kΩ
4.5 V	15 kΩ	43 kΩ	6.8 kΩ
5.0 V	15 kΩ	36 kΩ	5.1 kΩ
5.5 V	15 kΩ	39 kΩ	5.1 kΩ
6.0 V	15 kΩ	43 kΩ	5.1 kΩ
6.5 V	15 kΩ	62 kΩ	6.8 kΩ
7.0 V	15 kΩ	68 kΩ	6.8 kΩ
7.5 V	15 kΩ	82 kΩ	7.5 kΩ
8.0 V	15 kΩ	91 kΩ	8.2 kΩ
8.5 V	15 kΩ	82 kΩ	6.8 kΩ
9.0 V	15 kΩ	130 kΩ	10 kΩ
9.5 V	15 kΩ	91 kΩ	6.8 kΩ
10.0 V	15 kΩ	130 kΩ	9.1 kΩ

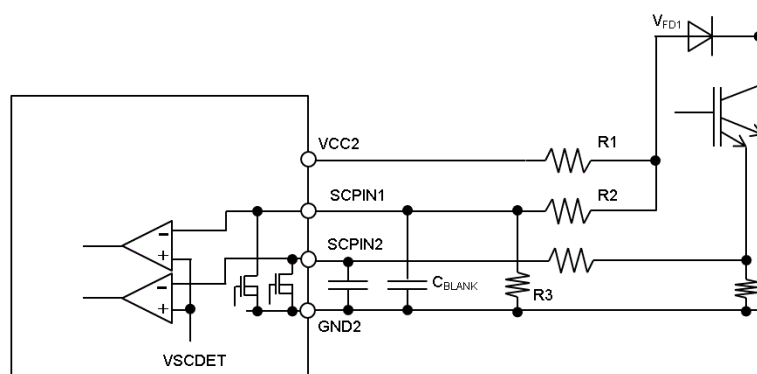

Figure 59. Block Diagram for DESAT

Description of Functions and Examples of Constant Setting – continued

(5) Temperature Monitor Function

The TO Pin Output Current (I_{TO}) is supplied from the TO pin from the built-in constant current circuit. This current value can be adjusted in accordance with the resistance value between the TC pin and the VEE2 pin. Furthermore, the TO pin voltage is converted to Duty and outputs the signal to the SENSOR pin.

$$I_{TO} = \frac{V_{TC}}{R_{TC}} \text{ [A]}$$

where:

I_{TO} is the TO pin Output Current.

V_{TC} is the TC pin Voltage.

R_{TC} is the resistance to determine the desired I_{TO} .

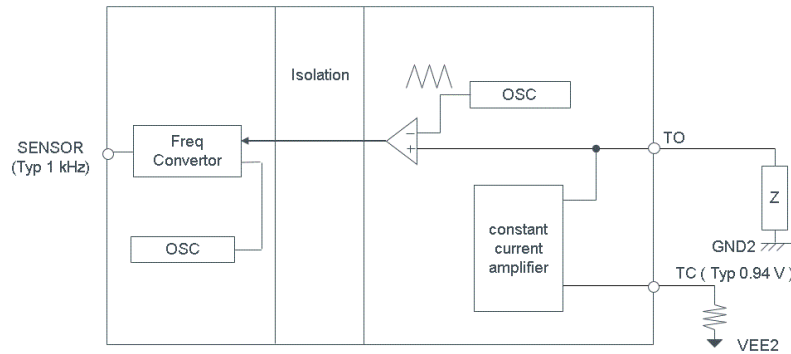

Figure 60. Block Diagram of Temperature Monitor Function

The SENSOR Duty is calculated according to the following calculating formula.

($V_{TO} < 1.35 \text{ V}$):

$$SENSOR \text{ Duty} = 10 \text{ [%]}$$

($1.35 \text{ V} \leq V_{TO} < 2.5 \text{ V}$):

$$SENSOR \text{ Duty} = 32 \times V_{TO} - 33.2 \text{ [%]}$$

($2.5 \text{ V} \leq V_{TO} \leq 3.84 \text{ V}$):

$$SENSOR \text{ Duty} = 32 \times V_{TO} - 32.9 \text{ [%]}$$

($3.84 \text{ V} < V_{TO}$):

$$SENSOR \text{ Duty} = 90 \text{ [%]}$$

where:

$SENSOR \text{ Duty}$ is the duty cycle obtained by converting the TO pin voltage.

V_{TO} is the TO pin voltage.

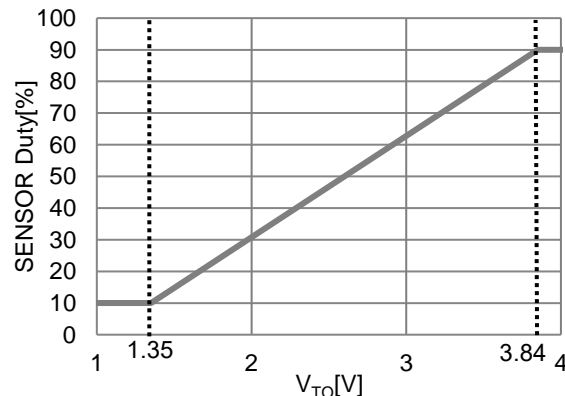

Figure 61. SENSOR Duty vs TO Voltage

Description of Functions and Examples of Constant Setting – continued

(6) Gate State Monitoring Function

When gate logic and input logic of output device monitored with the PROOUT1 pin are compared, a logic L is output from the RDY pin when they differ. In order to prevent the detection error due to delay of input and output, OSFB output filtering time $t_{OSFBFIL}$ is provided.

I/O Equivalence Circuit

Pin No.	Pin Name	Input Output Equivalence Circuit Diagram
	Pin Function	
2	PROOUT2	
	Soft turn-off pin 2	
13	OUT1L	
	Sink-side output pin	
3	PROOUT1	
	Soft turn-off pin 1 / Gate voltage input pin	
4	OUT2	
	Gate control pin for active miller clamping	
5	VREG	
	Power supply pin for driving MOSFET for active miller clamping	
6	TC	
	Resister connection pin for setting constant current source output	
7	TO	
	Constant current output pin / Sensor voltage input pin	

I/O Equivalence Circuit - continued

Pin No.	Pin Name	Input Output Equivalence Circuit Diagram
	Pin Function	
9	SCPIN2	
	Short circuit current detection pin 2	
10	SCPIN1	
	Short circuit current detection pin 1	
12	OUT1H	
	Source-side output pin	
16	FLT	
	Fault output pin	
20	RDY	
	Ready output pin	
17	ENA	
	Input enabling signal input pin	
18	INA	
	Control input pin	

I/O Equivalence Circuit - continued

Pin No.	Pin Name	Input Output Equivalence Circuit Diagram
	Pin Function	
19	INB	
	Control input pin	
21	SENSOR	
	Temperature information output pin	

Operational Notes

1. Reverse Connection of Power Supply

Connecting the power supply in reverse polarity can damage the IC. Take precautions against reverse polarity when connecting the power supply, such as mounting an external diode between the power supply and the IC's power supply pins.

2. Power Supply Lines

Design the PCB layout pattern to provide low impedance supply lines. Separate the ground and supply lines of the digital and analog blocks to prevent noise in the ground and supply lines of the digital block from affecting the analog block. Furthermore, connect a capacitor to ground at all power supply pins. Consider the effect of temperature and aging on the capacitance value when using electrolytic capacitors.

3. Ground Voltage

Ensure that no pins are at a voltage below that of the ground pin at any time, even during transient condition.

4. Ground Wiring Pattern

When using both small-signal and large-current ground traces, the two ground traces should be routed separately but connected to a single ground at the reference point of the application board to avoid fluctuations in the small-signal ground caused by large currents. Also ensure that the ground traces of external components do not cause variations on the ground voltage. The ground lines must be as short and thick as possible to reduce line impedance.

5. Recommended Operating Conditions

The function and operation of the IC are guaranteed within the range specified by the recommended operating conditions. The characteristic values are guaranteed only under the conditions of each item specified by the electrical characteristics.

6. Inrush Current

When power is first supplied to the IC, it is possible that the internal logic may be unstable and inrush current may flow instantaneously due to the internal powering sequence and delays, especially if the IC has more than one power supply. Therefore, give special consideration to power coupling capacitance, power wiring, width of ground wiring, and routing of connections.

7. Testing on Application Boards

When testing the IC on an application board, connecting a capacitor directly to a low-impedance output pin may subject the IC to stress. Always discharge capacitors completely after each process or step. The IC's power supply should always be turned off completely before connecting or removing it from the test setup during the inspection process. To prevent damage from static discharge, ground the IC during assembly and use similar precautions during transport and storage.

8. Inter-pin Short and Mounting Errors

Ensure that the direction and position are correct when mounting the IC on the PCB. Incorrect mounting may result in damaging the IC. Avoid nearby pins being shorted to each other especially to ground, power supply and output pin. Inter-pin shorts could be due to many reasons such as metal particles, water droplets (in very humid environment) and unintentional solder bridge deposited in between pins during assembly to name a few.

9. Unused Input Pins

Input pins of an IC are often connected to the gate of a MOS transistor. The gate has extremely high impedance and extremely low capacitance. If left unconnected, the electric field from the outside can easily charge it. The small charge acquired in this way is enough to produce a significant effect on the conduction through the transistor and cause unexpected operation of the IC. So unless otherwise specified, unused input pins should be connected to the power supply or ground line.

Operational Notes – continued

10. Regarding the Input Pin of the IC

This IC contains P+ isolation and P substrate layers between adjacent elements in order to keep them isolated. P-N junctions are formed at the intersection of the P layers with the N layers of other elements, creating a parasitic diode or transistor. For example (refer to figure below):

When GND > Pin A and GND > Pin B, the P-N junction operates as a parasitic diode.
 When GND > Pin B, the P-N junction operates as a parasitic transistor.

Parasitic diodes inevitably occur in the structure of the IC. The operation of parasitic diodes can result in mutual interference among circuits, operational faults, or physical damage. Therefore, conditions that cause these diodes to operate, such as applying a voltage lower than the GND voltage to an input pin (and thus to the P substrate) should be avoided.

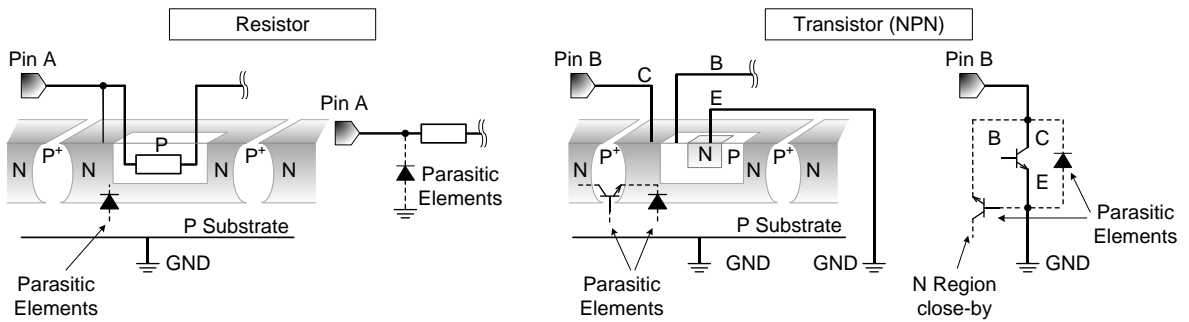
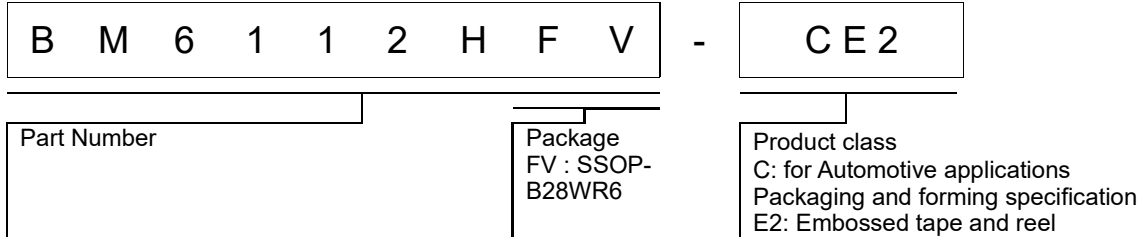

Figure 62. Example of IC Structure

11. Ceramic Capacitor

When using a ceramic capacitor, determine a capacitance value considering the change of capacitance with temperature and the decrease in nominal capacitance due to DC bias and others.

Ordering Information



Marking Diagram

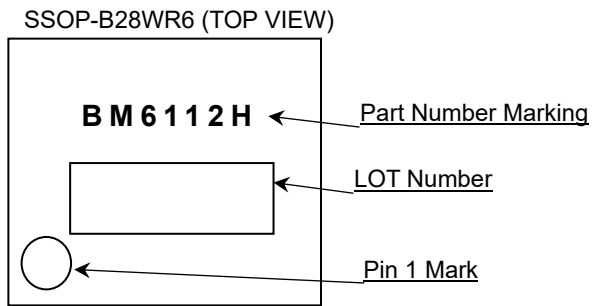

Physical Dimension and Packing Information

Package Name	SSOP-B28WR6
--------------	-------------

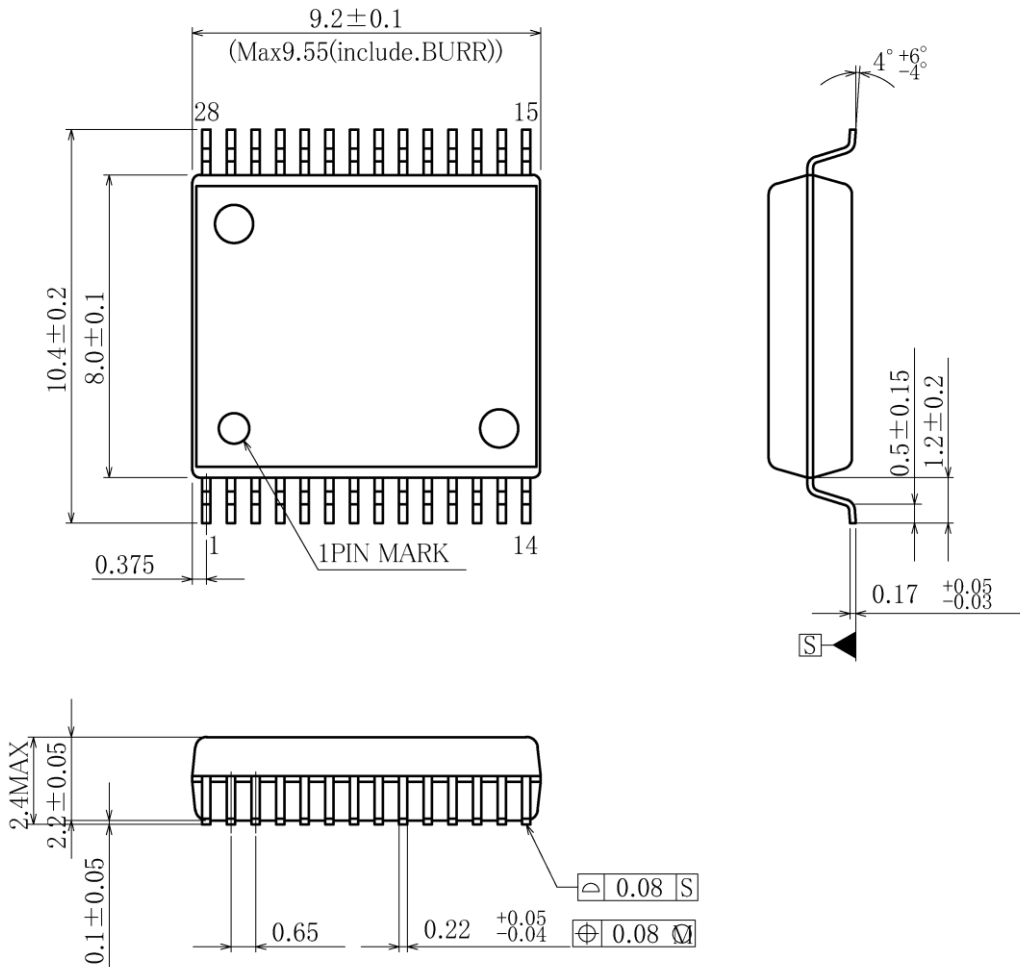

(UNIT:mm)
 PKG:SSOP-B28WR6
 Drawing No.EX072-5004

< Tape and Reel Information >

Tape	Embossed carrier tape
Quantity	1500pcs
Direction of feed	E2 The direction is the pin 1 of product is at the upper left when you hold reel on the left hand and you pull out the tape on the right hand

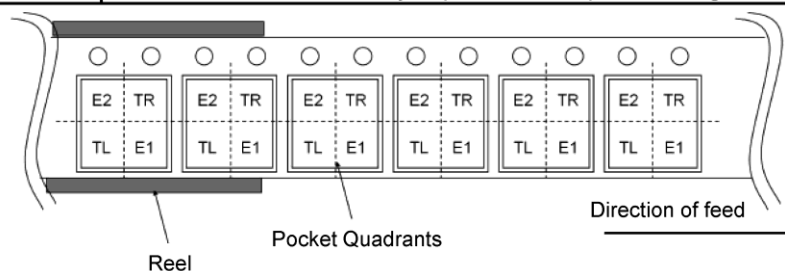

Revision History

Date	Revision	Changes
27.Apr.2023	001	New Release
30.Jan.2024	002	P1 Features: change IEC60747-17 Recognized P6 Change Insulation Related Characteristics

Notice

Precaution on using ROHM Products

1. If you intend to use our Products in devices requiring extremely high reliability (such as medical equipment ^(Note 1), aircraft/spacecraft, nuclear power controllers, etc.) and whose malfunction or failure may cause loss of human life, bodily injury or serious damage to property ("Specific Applications"), please consult with the ROHM sales representative in advance. Unless otherwise agreed in writing by ROHM in advance, ROHM shall not be in any way responsible or liable for any damages, expenses or losses incurred by you or third parties arising from the use of any ROHM's Products for Specific Applications.

(Note1) Medical Equipment Classification of the Specific Applications

JAPAN	USA	EU	CHINA
CLASS III	CLASS III	CLASS II b	CLASS III
CLASS IV		CLASS III	

2. ROHM designs and manufactures its Products subject to strict quality control system. However, semiconductor products can fail or malfunction at a certain rate. Please be sure to implement, at your own responsibilities, adequate safety measures including but not limited to fail-safe design against the physical injury, damage to any property, which a failure or malfunction of our Products may cause. The following are examples of safety measures:
 - [a] Installation of protection circuits or other protective devices to improve system safety
 - [b] Installation of redundant circuits to reduce the impact of single or multiple circuit failure
3. Our Products are not designed under any special or extraordinary environments or conditions, as exemplified below. Accordingly, ROHM shall not be in any way responsible or liable for any damages, expenses or losses arising from the use of any ROHM's Products under any special or extraordinary environments or conditions. If you intend to use our Products under any special or extraordinary environments or conditions (as exemplified below), your independent verification and confirmation of product performance, reliability, etc. prior to use, must be necessary:
 - [a] Use of our Products in any types of liquid, including water, oils, chemicals, and organic solvents
 - [b] Use of our Products outdoors or in places where the Products are exposed to direct sunlight or dust
 - [c] Use of our Products in places where the Products are exposed to sea wind or corrosive gases, including Cl₂, H₂S, NH₃, SO₂, and NO₂
 - [d] Use of our Products in places where the Products are exposed to static electricity or electromagnetic waves
 - [e] Use of our Products in proximity to heat-producing components, plastic cords, or other flammable items
 - [f] Sealing or coating our Products with resin or other coating materials
 - [g] Use of our Products without cleaning residue of flux (Exclude cases where no-clean type fluxes is used. However, recommend sufficiently about the residue.); or Washing our Products by using water or water-soluble cleaning agents for cleaning residue after soldering
 - [h] Use of the Products in places subject to dew condensation
4. The Products are not subject to radiation-proof design.
5. Please verify and confirm characteristics of the final or mounted products in using the Products.
6. In particular, if a transient load (a large amount of load applied in a short period of time, such as pulse, is applied, confirmation of performance characteristics after on-board mounting is strongly recommended. Avoid applying power exceeding normal rated power; exceeding the power rating under steady-state loading condition may negatively affect product performance and reliability.
7. De-rate Power Dissipation depending on ambient temperature. When used in sealed area, confirm that it is the use in the range that does not exceed the maximum junction temperature.
8. Confirm that operation temperature is within the specified range described in the product specification.
9. ROHM shall not be in any way responsible or liable for failure induced under deviant condition from what is defined in this document.

Precaution for Mounting / Circuit board design

1. When a highly active halogenous (chlorine, bromine, etc.) flux is used, the residue of flux may negatively affect product performance and reliability.
2. In principle, the reflow soldering method must be used on a surface-mount products, the flow soldering method must be used on a through hole mount products. If the flow soldering method is preferred on a surface-mount products, please consult with the ROHM representative in advance.

For details, please refer to ROHM Mounting specification

Precautions Regarding Application Examples and External Circuits

1. If change is made to the constant of an external circuit, please allow a sufficient margin considering variations of the characteristics of the Products and external components, including transient characteristics, as well as static characteristics.
2. You agree that application notes, reference designs, and associated data and information contained in this document are presented only as guidance for Products use. Therefore, in case you use such information, you are solely responsible for it and you must exercise your own independent verification and judgment in the use of such information contained in this document. ROHM shall not be in any way responsible or liable for any damages, expenses or losses incurred by you or third parties arising from the use of such information.

Precaution for Electrostatic

This Product is electrostatic sensitive product, which may be damaged due to electrostatic discharge. Please take proper caution in your manufacturing process and storage so that voltage exceeding the Products maximum rating will not be applied to Products. Please take special care under dry condition (e.g. Grounding of human body / equipment / solder iron, isolation from charged objects, setting of Ionizer, friction prevention and temperature / humidity control).

Precaution for Storage / Transportation

1. Product performance and soldered connections may deteriorate if the Products are stored in the places where:
 - [a] the Products are exposed to sea winds or corrosive gases, including Cl₂, H₂S, NH₃, SO₂, and NO₂
 - [b] the temperature or humidity exceeds those recommended by ROHM
 - [c] the Products are exposed to direct sunshine or condensation
 - [d] the Products are exposed to high Electrostatic
2. Even under ROHM recommended storage condition, solderability of products out of recommended storage time period may be degraded. It is strongly recommended to confirm solderability before using Products of which storage time is exceeding the recommended storage time period.
3. Store / transport cartons in the correct direction, which is indicated on a carton with a symbol. Otherwise bent leads may occur due to excessive stress applied when dropping of a carton.
4. Use Products within the specified time after opening a humidity barrier bag. Baking is required before using Products of which storage time is exceeding the recommended storage time period.

Precaution for Product Label

A two-dimensional barcode printed on ROHM Products label is for ROHM's internal use only.

Precaution for Disposition

When disposing Products please dispose them properly using an authorized industry waste company.

Precaution for Foreign Exchange and Foreign Trade act

Since concerned goods might be fallen under listed items of export control prescribed by Foreign exchange and Foreign trade act, please consult with ROHM in case of export.

Precaution Regarding Intellectual Property Rights

1. All information and data including but not limited to application example contained in this document is for reference only. ROHM does not warrant that foregoing information or data will not infringe any intellectual property rights or any other rights of any third party regarding such information or data.
2. ROHM shall not have any obligations where the claims, actions or demands arising from the combination of the Products with other articles such as components, circuits, systems or external equipment (including software).
3. No license, expressly or implied, is granted hereby under any intellectual property rights or other rights of ROHM or any third parties with respect to the Products or the information contained in this document. Provided, however, that ROHM will not assert its intellectual property rights or other rights against you or your customers to the extent necessary to manufacture or sell products containing the Products, subject to the terms and conditions herein.

Other Precaution

1. This document may not be reprinted or reproduced, in whole or in part, without prior written consent of ROHM.
2. The Products may not be disassembled, converted, modified, reproduced or otherwise changed without prior written consent of ROHM.
3. In no event shall you use in any way whatsoever the Products and the related technical information contained in the Products or this document for any military purposes, including but not limited to, the development of mass-destruction weapons.
4. The proper names of companies or products described in this document are trademarks or registered trademarks of ROHM, its affiliated companies or third parties.

General Precaution

1. Before you use our Products, you are requested to carefully read this document and fully understand its contents. ROHM shall not be in any way responsible or liable for failure, malfunction or accident arising from the use of any ROHM's Products against warning, caution or note contained in this document.
2. All information contained in this document is current as of the issuing date and subject to change without any prior notice. Before purchasing or using ROHM's Products, please confirm the latest information with a ROHM sales representative.
3. The information contained in this document is provided on an "as is" basis and ROHM does not warrant that all information contained in this document is accurate and/or error-free. ROHM shall not be in any way responsible or liable for any damages, expenses or losses incurred by you or third parties resulting from inaccuracy or errors of or concerning such information.