

LED Drivers for LCD Backlights

1ch Buck Type White LED Driver for Large LCD

BD94062F

General Description

BD94062F is a high efficiency driver for white LEDs and designed for large LCDs. BD94062F has a built-in quasi-resonant(QR) control method DCDC converter and continuous current mode(CCM) DCDC converter that can supply appropriate voltage to the light source of LEDs series array. By external current detection resistance, it achieves a power supply design with high flexibility.

Features

- QR or CCM Selectable(SEL Pin)
- LED Current Compensation Function(for QR)
- Under Voltage Protection(VCC Pin)
- Leading Edge Blanking Function(CS Pin)
- PWM and ADIM Dimming Operating
- Abnormal Detection Signal Output(FAILB Pin)
- LED PWM Dimming Over Duty Protection(ODP)

Applications

- TV, Computer Display
- Other LCD Backlighting

Key Specifications

- Operating Power Supply Voltage Range: VCC: 10.5V to 35.0V
- Operating Current: 3.0mA(Typ)
- Maximum Frequency QR: 800kHz(Min)
- Oscillation Frequency CCM(R_{RT}=100kΩ):150kHz(Typ)
- Operating Temperature Range: -40°C to +105°C

Package

SOP16

W(Typ) x D(Typ) x H(Max)
10.00mm x 6.20mm x 1.71mm

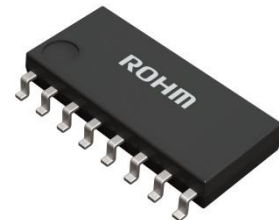

Typical Application Circuit

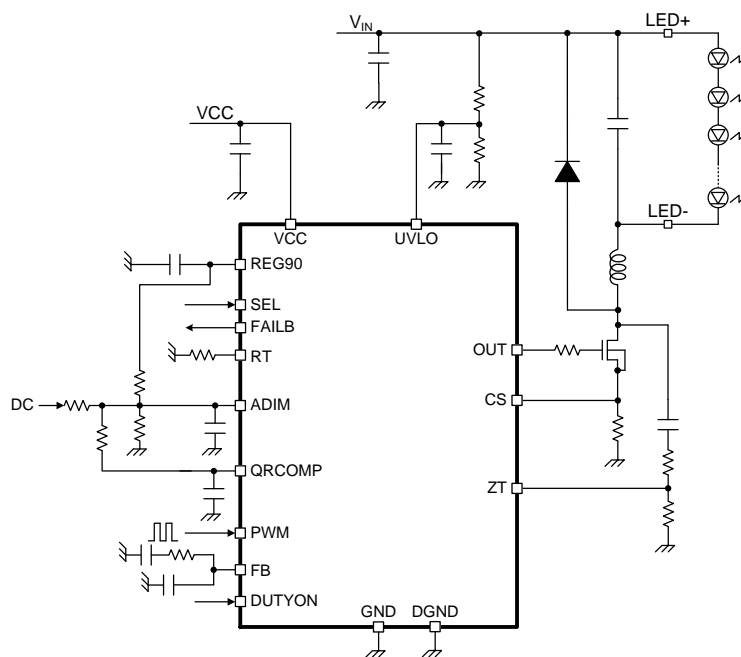

○Product structure: Silicon monolithic integrated circuit ○This product has no designed protection against radioactive rays

Pin Configuration



Pin Description

Pin No.	Pin Name	Function
1	VCC	IC power supply
2	UVLO	Application power supply UVLO detection
3	SEL	QR or CCM select
4	PWM	PWM dimming signal input
5	QRCOMP	DC output proportional to the OUT pin duty (When QR is selected)
6	ADIM	Analog dimming signal input
7	FAILB	Error detection output
8	DUTYON	Over duty protection ON/OFF select
9	RT	DCDC drive frequency setting(When CCM is selected)
10	ZT	Zero current detection
11	FB	Error amp output(When CCM is selected)
12	DGND	Digital GND
13	GND	GND
14	OUT	MOSFET GATE signal output
15	CS	Inductor current sensing
16	REG90	9.0V output voltage

Block Diagram

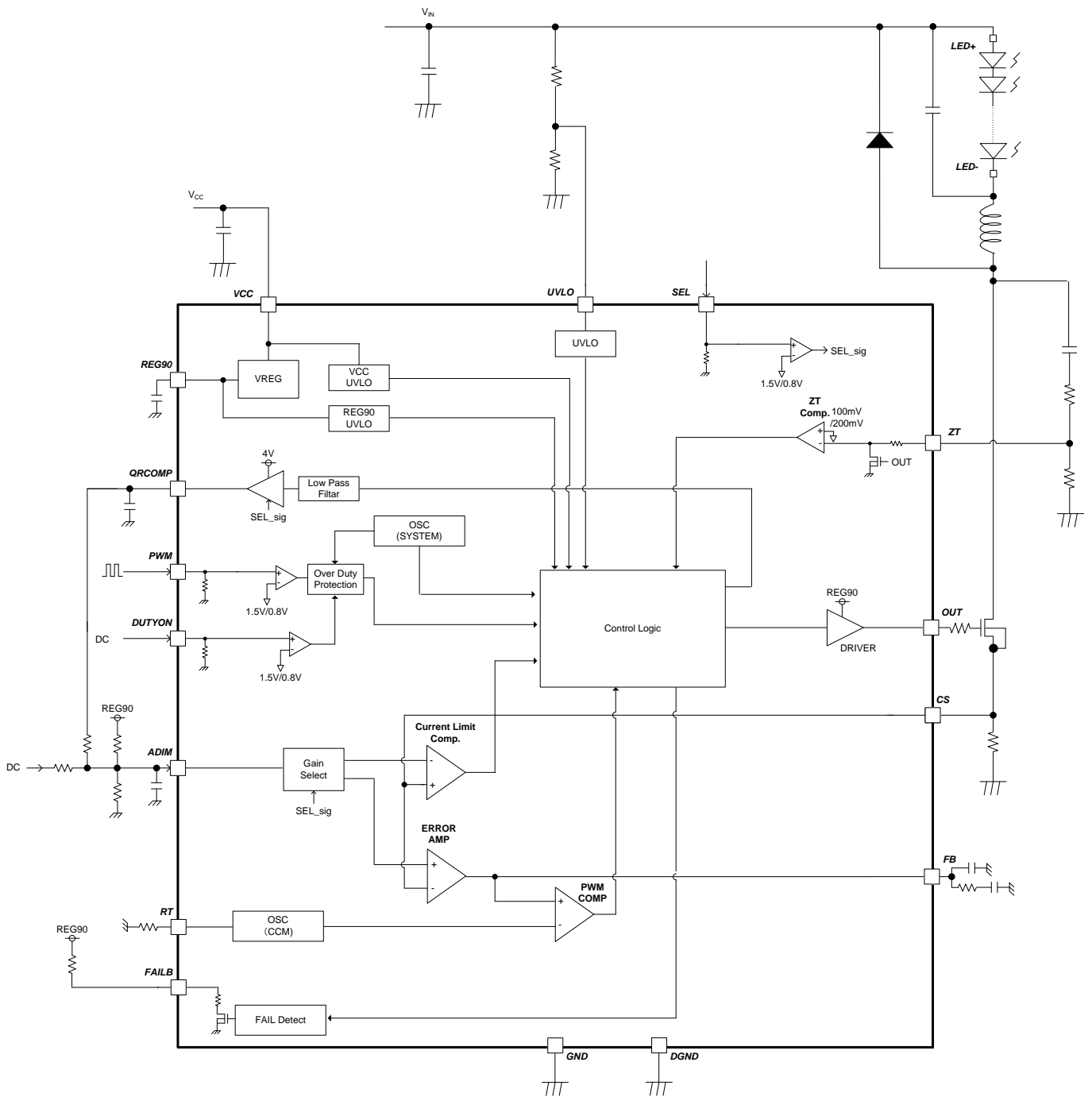

Pin Descriptions

If there is no description, the mentioned values are typical value.

○Pin 1: VCC

This is the power supply pin of the IC. The input range is 10.5V to 35.0V.

When $V_{UVLO} > V_{UVLOTH}(3.0V)$, the IC starts the buck operation and protection become effective after 524ms if $VCC > V_{VCC_UVREL}(9.0V)$.

When $VCC < V_{VCC_UVDET}(8.0V)$, the IC shut down.

The switching as the driver causes the VCC voltage amplitude. Input in the condition $VCC > 11.0V$ continuously.

○Pin 2: UVLO

This is the UVLO pin of the application power supply. The IC starts the buck operation if $V_{UVLO} > V_{UVLOTH}(3.0V)$ and stops if $V_{UVLO} < V_{UVLOTH}(3.0V)$. Refer to the timing chart in the section [UVLO Operation Waveform\(1\)](#) and [UVLO Operation Waveform\(2\)](#).

The UVLO pin is high impedance. Even if UVLO function is not used, input appropriate voltage because the open connection of this pin is not a fixed voltage.

○Pin 3: SEL

The select pin for QR or CCM. The input range of the L, H level of the SEL pin is the following.

The pull-down resistor is 1MΩ inside IC.

State	SEL Pin Voltage
SEL=H(QR)	$V_{SEL_H} = 1.5V \text{ to } 35.0V$
SEL=L(CCM)	$V_{SEL_L} = -0.3V \text{ to } +0.8V$

○Pin 4: PWM

This is the input pin of the PWM dimming signal. The dimming is realized by adjusting the input DUTY of the PWM pin.

The input range of the L, H level of the PWM pin is the following.

The pull-down resistor is 1MΩ inside IC.

If PWM=L continue for 524ms, the IC resets internal signal(start completion signal). At next PWM=H, the IC restarts.

State	PWM Pin Voltage
PWM=H	$V_{PWM_H} = 1.5V \text{ to } 35.0V$
PWM=L	$V_{PWM_L} = -0.3V \text{ to } +0.8V$

○Pin 5: QRCOMP

This is the pin which outputs DC voltage proportional to ON DUTY of the OUT pin at SEL=H and PWM=H. The circuit connected the QRCOMP pin revise the linearity of the LED current at QR.

The QRCOMP output internal hold voltage at SEL=H and PWM=L. The QRCOMP is the high impedance state at SEL=L.

When the IC detects an abnormality state, it is made pull-down by internal resistance.

To the QRCOMP pin, locate an anti-oscillation ceramic capacitor (0.1μF to 1.0μF) at the position as close as possible between the QRCOMP-GND pin.

Pin Descriptions - continued

○Pin 6: ADIM

This is the input pin for the analog dimming signal. Input appropriate voltage by all means from the outside. The CS pin detect (feedback) voltage is defined as 0.70 times (at QR selected, (SEL=H)) or 0.35 times (at CCM selected, (SEL=L)). If $V_{ADIM} > V_{CLPADIM2}(3.2V)$ at DUTYON=L, the CS detect (feedback) voltage is clamped to the constant level. It prevents from flowing large current into LED. If $V_{ADIM} > V_{CLPADIM1}(1.6V)$ or more at DUTYON=H, the CS detect (feedback) voltage is clamped to the constant level. It prevents from flowing large current into LED. In this condition, the input current of the ADIM pin is caused.

As for the relations of the ADIM pin voltage and current detect (feedback) voltage V_{CS} (the CS pin voltage), the equation is the following.

Current detect voltage V_{CSQR} at QR selected (SEL=H) and DUTYON=L

$$V_{CSQR} = V_{ADIM} \times 0.7 \quad [V] \quad (V_{ADIM} \leq 3.2V, SEL = H, DUTYON = L)$$

$$V_{CSQR} = 2.240 \quad [V] \quad (V_{ADIM} > 3.2V, SEL = H, DUTYON = L)$$

Current detect voltage V_{CSQR} at QR selected (SEL=H) and DUTYON=H

$$V_{CSQR} = V_{ADIM} \times 0.7 \quad [V] \quad (V_{ADIM} \leq 1.6V, SEL = H, DUTYON = H)$$

$$V_{CSQR} = 1.120 \quad [V] \quad (V_{ADIM} > 1.6V, SEL = H, DUTYON = H)$$

Current feedback voltage V_{CSCCM} at CCM selected (SEL=L) and DUTYON=L

$$V_{CSCCM} = V_{ADIM} \times 0.35 \quad [V] \quad (V_{ADIM} \leq 3.2V, SEL = L, DUTYON = L)$$

$$V_{CSCCM} = 1.120 \quad [V] \quad (V_{ADIM} > 3.2V, SEL = L, DUTYON = L)$$

Current feedback voltage V_{CSCCM} at CCM selected (SEL=L) and DUTYON=H

$$V_{CSCCM} = V_{ADIM} \times 0.35 \quad [V] \quad (V_{ADIM} \leq 1.6V, SEL = L, DUTYON = H)$$

$$V_{CSCCM} = 0.560 \quad [V] \quad (V_{ADIM} > 1.6V, SEL = L, DUTYON = H)$$

○Pin 7: FAILB

This is the error detection output pin (OPEN DRAIN). The NMOS is OPEN state during normal operation and ON (500Ω) during error detection.

○Pin 8: DUTYON

This is the ON/OFF setting pin of the PWM Over Duty Protection (ODP). PWM ON time is limited at ODP=ON. By the DUTYON pin input voltage, ON/OFF of the ODP and ADIM clamp voltage are selected.

The pull-down resistor is 1MΩ inside IC.

At ODP=ON, don't set PWM frequency 50Hz or less and PWM DUTY 30% or more.

State	DUTYON Pin Voltage	ADIM Clamp Voltage
ODP = ON	$V_{DUTYON_L} = -0.3V$ to $+0.8V$	$V_{CLPADIM2} = 3.2V$
ODP = OFF	$V_{DUTYON_H} = 1.5V$ to $35.0V$	$V_{CLPADIM1} = 1.6V$

○Pin 9: RT

DCDC oscillation setting resistance connection pin (When CCM is selected). DCDC drive frequency is determined by connecting the RT resistance.

○Relation between the Drive Frequency and RT Resistance (ideal)

$$R_{RT} = \frac{15000}{f_{CTCCM} \times 10^{-3}} \quad [k\Omega]$$

However, oscillation setting range is 50kHz to 800kHz.

Pin Descriptions - continued

○Pin 10: ZT

The ZT pin controls OFF width(turn on). There are two factors to assert OUT=H at QR selected.

- (i) At the timing that the coil current decrease to zero, the drain voltage of the MOSFET drops. The divided voltage by resistor is input to the ZT pin. When $V_{ZT} < V_{ZTDET}(100mV)$ cross, the OUT=H signal is generated. (ONE SHOT operation)
- (ii) The ZT time out function is a function to turn ON MOSFET forcibly, when it does not change to OUT=H even if it passes for a certain period $t_{ZTOUT}(25\mu s)$, after it becomes OUT=L. Refer to the [ZT Trigger Time-out Operation Waveform](#).

Both factors (i) and (ii) are restricted for ON timing when oscillatory frequency is too fast, by maximum frequency $f_{MAXQR}=800kHz(\text{Min})$.

In addition, the MOSFET is not turned on, in the input condition that should be off such as $CS > 3.0V$.

For prevention of this false detection, it has a built-in blanking function(500ns) that mask ZT detection after MOSFET is turned OFF from ON state (Leading Edge Blanking function) at QR selected. When the state that $V_{ZT} < V_{ZTDET}(100mV)$ cross in the mask time(ZT LEB term) continues 60 μs , it is judged as an abnormal condition. After having stopped operation between 524ms, the operation is restarted.

The ZT pin monitors the drain voltage of the MOSFET at CCM selected, but the timing of the turn on is fixed by f_{CTCCM} that is decided by R_{RT} .

○Pin 11: FB

This is the output pin of the DCDC error amp (When CCM is selected).

FB is 100 μA source mode at CCM start state. CCM start state is finished at $V_{FB} > 3.7V$ or $V_{CS} > V_{CS_{CCM}}$, it becomes the output pin of the DCDC error amp at OUT=H and the high impedance state at OUT=L.

Error of over boost (FBMAX) is detected when $V_{FB} > V_{FBH}(4.0V)$. When state that $V_{FB} > V_{FBH}(4.0V)$ continues for a certain period of time (60 μs), MOSFET is turned off forcibly. After 524ms, the IC restarts.

At QR selected, the FB pin is pull-down with internal resistor.

○Pin 12: DGND

This is the digital GND of the IC.

○Pin 13: GND

This is the GND of the IC.

○Pin 14: OUT

The gate signal of the MOSFET is output. The output High level is 9V.

○Pin 15: CS

This pin controls ON width(turn-off) of the switching MOSFET. The current detection(feedback) voltage is set by the DC voltage of the ADIM pin. Refer to [the ADIM pin description](#).

In the timing of turn ON of the MOSFET, switching noise is generated. Because the CS voltage rises then, the OFF detecting circuit may do wrong detection. For prevention of this false detection, it has a built-in blanking function(at QR selected: 250ns, at CCM selected: 500ns) that mask CS detection after MOSFET is turned ON from OFF state (Leading Edge Blanking function).

This pin has three kinds of protection functions as following.

(i) CS OVP

When $V_{CS} > V_{CS_{OVP}}$, because of flowing larger current than normal dimming operation into current detection resistor, the state is judged as an abnormal after 15 μs and outputs FAILB signal. After having stopped operation for 524ms, the operation is restarted. Refer to the [CS OVP Operation Waveform\(1\)](#) and [CS OVP Operation Waveform\(2\)](#).

(ii) CS LOW

When CS=L and PWM=H continue 60 μs without inputting normal voltage into the CS pin, the state is judged as an abnormal condition. After having stopped operation for 524ms, the operation is restarted. Refer to the [CS LOW Operation Waveform\(1\)](#) and [CS LOW Operation Waveform\(2\)](#).

(iii) CS LEB DET

When the state that $V_{CS} > V_{CS_{OVP}}$ continues 60 μs at the time of the mask time(CS LEB term) completion, the state is judged as an abnormal condition and outputs FAILB signal. After having stopped operation for 524ms, the operation is restarted. Refer to the [CS LED BET Operation Waveform\(1\)](#) and [CS LED BET Operation Waveform\(2\)](#).

Pin Descriptions - continued

○Pin 16: REG90

This is the 9.0V output pin. Available current is 15mA(Min).
The characteristic of VCC line regulation at REG90 is shown as the right figure. VCC must be used in 10.5V or more for stable 9V output.

Place the ceramic capacitor connected to REG90 pin(1.0 μ F to 10 μ F) closest to the REG90-GND pin.

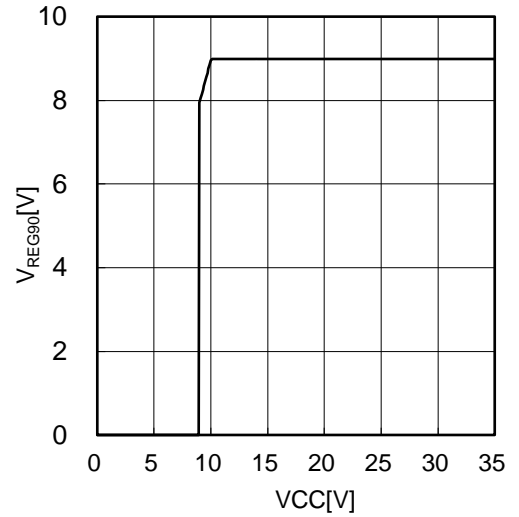

Figure 1. REG90 Line Regulation

Absolute Maximum Ratings(Ta=25°C)

Parameter	Symbol	Rating	Unit
Power Supply Voltage	VCC	-0.3 to +36	V
UVLO, SEL, PWM, ADIM, DUTYON Pin Voltage	V _{UVLO} , V _{SEL} , V _{PWM} , V _{ADIM} , V _{DUTYON}	-0.3 to +36	V
RT, FB, QRCOMP Pin Voltage	V _{RT} , V _{FB} , V _{QRCOMP}	-0.3 to +7.0	V
CS Pin Voltage	V _{CS}	-0.3 to +6.5	V
ZT Pin Voltage	V _{ZT}	-1.0 to +10.5	V
OUT Pin Voltage	V _{OUT}	-0.3 to +15.0	V
REG90 Pin Voltage	V _{REG90}	-0.3 to +13.0	V
FAILB Pin Voltage	V _{FAILB}	-0.3 to +22.0	V
ZT Pin Current	I _{ZT}	±4	mA
Maximum Junction Temperature	T _{jmax}	150	°C
Storage Temperature Range	T _{stg}	-55 to +150	°C

Caution 1: Operating the IC over the absolute maximum ratings may damage the IC. The damage can either be a short circuit between pins or an open circuit between pins and the internal circuitry. Therefore, it is important to consider circuit protection measures, such as adding a fuse, in case the IC is operated over the absolute maximum ratings.

Caution 2: Should by any chance the maximum junction temperature rating be exceeded the rise in temperature of the chip may result in deterioration of the properties of the chip. In case of exceeding this absolute maximum rating, design a PCB boards with thermal resistance taken into consideration by increasing board size and copper area so as not to exceed the maximum junction temperature rating.

Thermal Resistance(Notes 1)

Parameter	Symbol	Thermal Resistance(Typ)		Unit
		1s(Notes 3)	2s2p(Notes 4)	
SOP16				
Junction to Ambient	θ_{JA}	169.7	115.4	°C/W
Junction to Top Characterization Parameter(Notes 2)	Ψ_{JT}	21	20	°C/W

(Notes 1) Based on JESD51-2A(Still-Air).

(Notes 2) The thermal characterization parameter to report the difference between junction temperature and the temperature at the top center of the outside surface of the component package.

(Notes 3) Using a PCB board based on JESD51-3.

Layer Number of Measurement Board	Material	Board Size
Single	FR-4	114.3mm x 76.2mm x 1.57mm
Top		
Copper Pattern	Thickness	
Footprints and Traces	70μm	

(Notes 4) Using a PCB board based on JESD51-7.

Layer Number of Measurement Board	Material	Board Size			
4 Layers	FR-4	114.3mm x 76.2mm x 1.6mm			
Top		2 Internal Layers		Bottom	
Copper Pattern	Thickness	Copper Pattern	Thickness	Copper Pattern	Thickness
Footprints and Traces	70μm	74.2mm x 74.2mm	35μm	74.2mm x 74.2mm	70μm

Recommended Operating Conditions

Parameter	Symbol	Min	Typ	Max	Unit
Operating Temperature	T _{opr}	-40	+25	+105	°C
Power Supply Voltage	VCC	10.5	12.0	35.0	V
ADIM Input Voltage 1(V _{DUTYON} =3.0V)(Notes 5)	V _{ADIM1}	0.45	1.00	1.50	V
ADIM Input Voltage 2(V _{DUTYON} =0.0V)(Notes 5)	V _{ADIM2}	0.45	1.00	3.00	V
REG90 Pin Connection Capacitance(Notes 6)	C _{REG90}	1.0	2.2	10.0	μF
QRCOMP Pin Connection Capacitance(Notes 6)	C _{QRCOMP}	0.10	0.22	1.00	μF
RT Pin Connection Resistance(Notes 5)	R _{RT}	18.75	100	300	kΩ

(Notes 5) It is recommended not to exceed Maximum Frequency QR(f_{MAXQR}) and OUT Pin Maximum ON Width(t_{MAXON}).

(Notes 6) There are the characteristic parts that effective capacitance value largely becomes small when the DC voltage is applied, and be careful because output voltage may oscillate.

Electrical Characteristics(Unless otherwise specified VCC=12V, Ta=25°C)

Parameter	Symbol	Min	Typ	Max	Unit	Conditions
Circuit Current						
Circuit Current(ON)	I _{ON}	-	3.0	6.0	mA	V _{PWM} =0.0V, V _{DUTYON} =3.0V
UVLO						
VCC UVLO Release Voltage	V _{VCC_UVREL}	8.5	9.0	9.5	V	VCC: Sweep Up
VCC UVLO Detection Voltage	V _{VCC_UVDET}	7.5	8.0	8.5	V	VCC: Sweep Down
UVLO Threshold Voltage	V _{UVLOTH}	2.889	3.000	3.111	V	V _{UVLO} : Sweep Down
UVLO Pin Leak Current	I _{UVLO_LK}	-2	0	+2	μA	V _{UVLO} =4.0V
DC/DC Converter						
ZT Comparator Detection Voltage	V _{ZTDET}	60	100	140	mV	V _{ZT} : Sweep Down
ZT Comparator Release Voltage	V _{ZTREL}	120	200	280	mV	V _{ZT} : Sweep Up
ZT Comparator Hysteresis	V _{ZTHYS}	-	100	-	mV	V _{ZTHYS} =V _{ZTREL} -V _{ZTDET}
ZT Trigger Time-out Time QR	t _{ZTOUT}	20	25	30	μs	V _{CS} =0.0V, V _{SEL} =3.0V
OUT Pin High-side ON Resistance	R _{OUT_SRC}	-	5.0	10.0	Ω	
OUT Pin Low-side ON Resistance	R _{OUT_SINK}	-	4.0	8.0	Ω	
Oscillation Frequency CCM	f _{CTCCM}	142.5	150.0	157.5	kHz	R _{RT} =100kΩ, V _{SEL} =0.0V
Current Detection Voltage QR 1	V _{CSQR1}	0.686	0.700	0.714	V	V _{ADIM} =1.0V, V _{SEL} =3.0V, V _{DUTYON} =3.0V
Current Detection Voltage QR 2	V _{CSQR2}	1.034	1.050	1.066	V	V _{ADIM} =1.5V, V _{SEL} =3.0V, V _{DUTYON} =3.0V
Current Detection Clamp Voltage QR 1	V _{CLPQR1}	1.073	1.120	1.167	V	V _{ADIM} =4.0V, V _{SEL} =3.0V, V _{DUTYON} =3.0V
Current Detection Clamp Voltage QR 2	V _{CLPQR2}	2.175	2.240	2.305	V	V _{ADIM} =4.0V, V _{SEL} =3.0V, V _{DUTYON} =0.0V
Current Feedback Voltage CCM 1	V _{CSCCM1}	0.340	0.350	0.360	V	V _{ADIM} =1.0V, V _{SEL} =0.0V, V _{DUTYON} =0.0V
Current Feedback Voltage CCM 2	V _{CSCCM2}	0.512	0.525	0.538	V	V _{ADIM} =1.5V, V _{SEL} =0.0V, V _{DUTYON} =0.0V
Current Feedback Clamp Voltage CCM 1	V _{CLPCCM1}	0.534	0.560	0.586	V	V _{ADIM} =4.0V, V _{SEL} =0.0V, V _{DUTYON} =3.0V
Current Feedback Clamp Voltage CCM 2	V _{CLPCCM2}	1.085	1.120	1.155	V	V _{ADIM} =4.0V, V _{SEL} =0.0V, V _{DUTYON} =0.0V
Maximum Frequency QR	f _{MAXQR}	800	-	-	kHz	V _{SEL} =3.0V
CS Leading Edge Blank Time QR	t _{CSLEBQR}	-	0.25	-	μs	V _{SEL} =3.0V
CS Leading Edge Blank Time CCM	t _{CSLEBCCM}	-	0.50	-	μs	V _{SEL} =0.0V
OUT Pin Maximum ON Width	t _{MAXON}	15	20	25	μs	
OUT Pin Maximum Duty CCM	D _{MAXCCM}	90	95	99	%	R _{RT} =100kΩ, V _{SEL} =0.0V, V _{FB} =3.5V
FB Source Current CCM	I _{FB_SO}	-115	-100	-85	μA	V _{CS} =0.15V, V _{ADIM} =1.5V, V _{FB} =1.0V, V _{SEL} =0.0V
FB Sink Current CCM	I _{FB_SI}	85	100	115	μA	V _{CS} =1.0V, V _{ADIM} =1.5V, V _{FB} =1.0V, V _{SEL} =0.0V

Electrical Characteristics(Unless otherwise specified VCC=12V, Ta=25°C) - continued

Parameter	Symbol	Min	Typ	Max	Unit	Conditions
DC/DC Protection						
CS OVP Voltage 1	V _{CSOVP1}	0.686	0.700	0.714	V	V _{ADIM} =1.0V, V _{DUTYON} =3.0V
CS OVP Voltage 2	V _{CSOVP2}	1.034	1.050	1.066	V	V _{ADIM} =1.5V, V _{DUTYON} =3.0V
CS OVP Voltage 3	V _{CSOVP3}	2.175	2.240	2.305	V	V _{ADIM} =4.0V, V _{DUTYON} =0.0V
CS OVP Mask Time	t _{SURMSK}	10	15	20	μs	
CS LOW Voltage QR1	V _{CSLQR1}	0.686	0.700	0.714	V	V _{ADIM} =1.0V, V _{DUTYON} =3.0V, V _{SEL} =3.0V
CS LOW Voltage QR2	V _{CSLQR2}	1.034	1.050	1.066	V	V _{ADIM} =1.5V, V _{DUTYON} =3.0V, V _{SEL} =3.0V
CS LOW Voltage QR3	V _{CSLQR3}	2.175	2.240	2.305	V	V _{ADIM} =4.0V, V _{DUTYON} =0.0V, V _{SEL} =3.0V
CS LOW Voltage CCM	V _{CSLCCM}	0.05	0.10	0.15	V	V _{SEL} =0.0V
RT Short Circuit Protection Range	V _{RTL}	-0.3	-	V _{RT} x 90%	V	V _{RT} : Sweep Down
Over Boost Detection Voltage	V _{FBH}	3.84	4.00	4.16	V	V _{FB} : Sweep Up
REG90						
REG90 Output Voltage 1	V _{REG90_1}	8.910	9.000	9.090	V	I _{REG90} =0mA
REG90 Output Voltage 2	V _{REG90_2}	8.865	9.000	9.135	V	I _{REG90} =-15mA
REG90 Max Source Current	I _{REG90_SOMAX}	15	-	-	mA	
REG90_UVLO Detect Voltage	V _{REG90_UVDET}	5.22	6.00	6.78	V	V _{REG90} : Sweep Down
DUTYON						
DUTYON Pin HIGH Voltage	V _{DUTYON_H}	1.5	-	35	V	V _{DUTYON} : Sweep Up
DUTYON Pin LOW Voltage	V _{DUTYON_L}	-0.3	-	+0.8	V	V _{DUTYON} : Sweep Down
DUTYON Pin Pull-Down Resistance	R _{DUTYON}	600	1000	1400	kΩ	V _{DUTYON} =3.0V
Over Duty Protection						
PWM ODP Protection Detection Duty	D _{ODP}	30	-	-	%	f _{PWM} =50Hz, D _{PWM} =50%
QR, CCM Selection						
SEL Pin HIGH Voltage	V _{SEL_H}	1.5	-	35	V	V _{SEL} : Sweep Up
SEL Pin LOW Voltage	V _{SEL_L}	-0.3	-	+0.8	V	V _{SEL} : Sweep Down
SEL Pin Pull-Down Resistance	R _{SEL}	600	1000	1400	kΩ	V _{SEL} =3.0V
Dimming Control						
PWM Pin HIGH Voltage	V _{PWM_H}	1.5	-	35	V	V _{PWM} : Sweep Up
PWM Pin LOW Voltage	V _{PWM_L}	-0.3	-	+0.8	V	V _{PWM} : Sweep Down
PWM Pin Pull-Down Resistance	R _{PWM}	600	1000	1400	kΩ	V _{PWM} =3.0V
ADIM Pin Leak Current	I _{ADIM_LK}	-2	0	+2	μA	V _{ADIM} =1.0V
QRCOMP						
QRCOMP Pin Duty Range	D _{QRCOMP}	10	-	90	%	V _{SEL} =3.0V
QRCOMP Pin Output Voltage	V _{QRCOMP}	1.94	2.0	2.06	V	f _{OUT} =100kHz, D _{OUT} =50.0%, V _{SEL} =3.0V
QRCOMP Max Output Current	I _{QRC_MAX}	400	-	-	μA	V _{QRCOMP} =2.0V, V _{PWM} =3.0V, V _{SEL} =3.0V
QRCOMP Pin Leak Current	I _{QRC_LK}	-2	0	+2	μA	V _{QRCOMP} =2.0V, V _{PWM} =3.0V, V _{SEL} =0.0V
FAILB						
FAILB Pin Pull-Down Resistance	R _{FAILBL}	250	500	1000	Ω	I _{FAILB} =1.0mA

The List of the Protection Function Condition and Operation

If there is no description, the mentioned values are typical value.

The operation of each protection is shown in Table 1.

Refer to [Starting Up Waveform\(1\)](#), [Starting Up Waveform\(2\)](#), [Starting Up Waveform\(3\)](#) and [Starting Up Waveform\(4\)](#) for the start completion condition.

When it is contained in plural protection detection conditions, the high-priority thing is carried out.

For example, when the IC becomes both protection detection conditions of VCC UVLO(Priority:[2]) and CS OVP(Priority:[3]), VCC UVLO(Priority:[2]) is given priority to and the IC doesn't output FAILB=L.

Table 1. The Operation Mode of the Protection

Protection Name	Detection Pin	Detection Condition	Release Condition	Detection Timer	Protection Type	Operation at Detection			Priority
						O U T	FAILB	Auto-Restart Timer	
REG90 UVLO	REG90	$V_{REG90} < V_{REG90_UVDET}(6.0V)$	$V_{REG90} > V_{REG90_UVREL}(6.6V)$	Immediately	Immediately Auto-Restart	L	Normal	Immediately	[1]
VCC UVLO	VCC	$V_{VCC} < V_{VCC_UVDET}(8.0V)$	$V_{VCC} > V_{VCC_UVREL}(9.0V)$ for 524ms	Immediately	Immediately Auto-Restart	L	Normal	Immediately	[2]
UVLO	UVLO	$V_{UVLO} < V_{UVLOTH}(3.0V)$	$V_{UVLO} > V_{UVLOTH}(3.0V)$	Immediately	Auto-Restart	L	Normal	524ms	[2]
RT HIGH	RT	$V_{RT} > V_{RTH}(5.5V(Max))$	$V_{RT} < V_{RTH}(5.5V(Max))$	Immediately	Immediately Auto-Restart	L	Normal	Immediately	[2]
RT LOW	RT	$V_{RT} < V_{RTL}(V_{RT_NM} \times 90\%(Min))$	$V_{RT} > V_{RTL}(V_{RT_NM} \times 90\%(Min))$	Immediately	Immediately Auto-Restart	L	Normal	Immediately	[2]
CS OVP	CS	$V_{CS} > V_{CSOVP}$	$V_{CS} < V_{CSOVP}$	15μs	Auto-Restart	L	L after timer operation	524ms	[3]
CS LOW (QR)	CS	Start Completion and $V_{CS} < V_{CSLQR}$ and PWM=H	$V_{CS} > V_{CSLQR}$ or PWM=L	60μs	Auto-Restart	L	Normal	524ms	[3]
CS LOW (CCM)	CS	Start Completion and $V_{CS} < V_{CSLCCM}(0.1V)$ and PWM=H	$V_{CS} > V_{CSLCCM}(0.1V)$ or PWM=L	60μs	Auto-Restart	L	Normal	524ms	[3]
CS LEB DET (QR)	CS	Start Completion and $V_{CS} > V_{CSOVP}$ at $t_{CSLEBQR}(0.25\mu s)$ Completion and PWM=H	$V_{CS} < V_{CSOVP}$ at $t_{CSLEBQR}(0.25\mu s)$ Completion or PWM=L	60μs	Auto-Restart	L	L after timer operation	524ms	[3]
CS LEB DET (CCM)	CS	Start Completion and $V_{CS} > V_{CSOVP}$ at $t_{CSLEBCCM}(0.50\mu s)$ Completion and PWM=H	$V_{CS} < V_{CSOVP}$ at $t_{CSLEBCCM}(0.50\mu s)$ Completion or PWM=L	60μs	Auto-Restart	L	L after timer operation	524ms	[3]
ZT LEB DET	ZT	SEL=H and Start Completion and $V_{ZT} < V_{ZTDET}(0.1V)$ Edge Detection in $t_{ZTLEB}(0.50\mu s)$	SEL=L or $V_{ZT} < V_{ZTDET}(0.1V)$ Edge No Detection in $t_{ZTLEB}(0.50\mu s)$	60μs	Auto-Restart	L	Normal	524ms	[3]
FB MAX	FB	Start Completion and $V_{FB} > V_{FBH}(4.0V)$	$V_{FB} < V_{FBH}(4.0V)$	60μs	Auto-Restart	L	Normal	524ms	[3]

Parts Setting Example(QR)

If there is no description, the mentioned values are typical value. Following symbol are shown in the right diagram.

- [1]...During M1=ON, as the coil(L) voltage of its both side can approximate $V_{IN}-V_{LED}$, the slope of I_L ; Slope $_{IL_ON}$ is

$$Slope_{IL_ON} = \frac{V_{IN} - V_{LED}}{L}$$

- [2]...During M1=OFF, as the coil(L) voltage of its both side can approximate V_{LED} , the slope of I_L ; Slope $_{IL_OFF}$ is

$$Slope_{IL_OFF} = \frac{V_{LED}}{L}$$

The equation can be expressed above.

It is necessary for V_{IN} , V_{LED} and L to meet the following condition.

- (a) Maximum ON time of the MOSFET(M1)(t_{MAXON}) is 20 μ s.

$$t_{OUT_ON} < t_{MAXON}$$

- (b) Maximum frequency of the resonance frequency(f_{MAXQR}) is 800kHz(Min).

$$\frac{1}{t_{OUT_ON} + t_{OUT_OFF}} < f_{MAXQR}$$

Refer the [Maximum Frequency Operation Waveform](#) and [Maximum On Time Operation Waveform](#).

- [3]...When the MOSFET M1 is turned off, ZT increases by the SW bounce.

- [4]...After that, the ZT pin gradually decreases, the slope is decided by C1, R1 and R2.

- [5]...At the timing of $I_L=0mA$, SW suddenly decreases, and ZT decreases suddenly too. The ZT slope is decided by C1, R1 and R2. The delay exists from the timing $I_L=0mA$ to reach the detection level 100mV of ZT.

C_{OUT} smoothies an LED current. Ripple current of the LED becomes large with small C_{OUT} . When large C_{OUT} is used, the response of an LED current is slow at PWM dimming. R_g can set the switching response speed of M1.

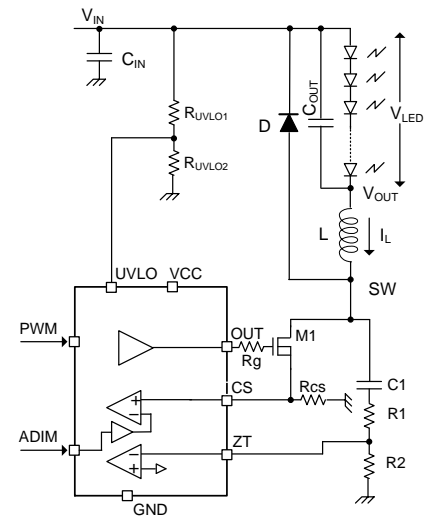

Figure 2. Application Circuits

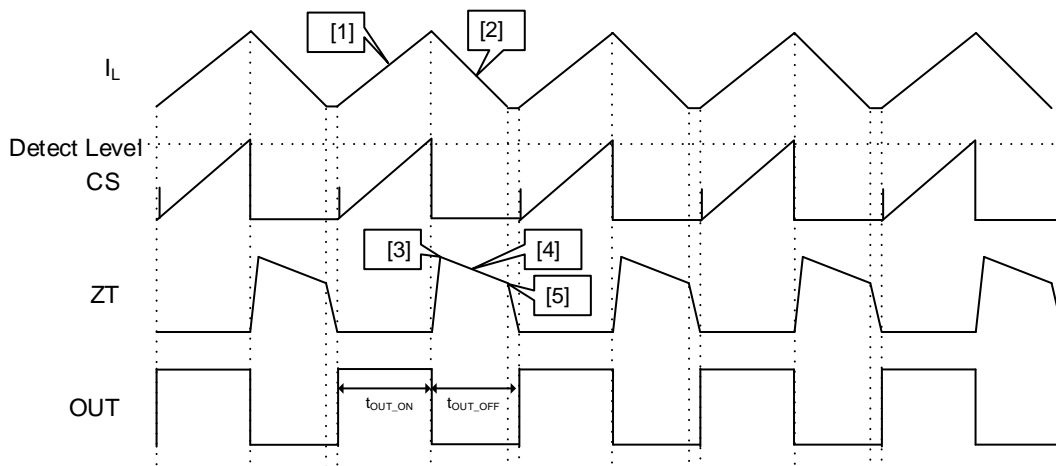

Figure 3. Dimming Waveform

LED Current Setting(QR)

If there is no description, the mentioned values are typical value.

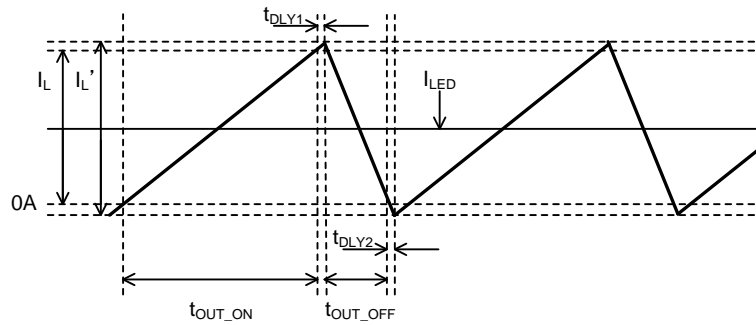

Figure 4. Coil Current and LED Current

The LED current(I_{LED}) is expressed as follows.

OLED Current(I_{LED}) Setting Equation(Rough Estimate)

$$I_{LED} = \frac{1}{2} \times \left(\frac{V_{CSQR}}{R_{CS}} + \frac{V_{IN} - V_{LED}}{L} \times t_{DLY1} - \frac{V_{LED}}{L} \times t_{DLY2} \right) \times 10^3 \quad [\text{mA}]$$

where

t_{DLY1} is the turn-off delay time of the MOSFET(M1).

t_{DLY2} is the turn-on delay time of the MOSFET(M1).

$$V_{CSQR} = V_{ADIM} \times 0.7 \quad [\text{V}] \quad (V_{ADIM} \leq 1.6\text{V}, SEL = H, DUTYON = H)$$

$$V_{CSQR} = 1.120 \quad [\text{V}] \quad (V_{ADIM} > 1.6\text{V}, SEL = H, DUTYON = H)$$

[Setting Example]

If $V_{IN}=100\text{V}$, $V_{LED}=60\text{V}$, $V_{CSQR}=0.7\text{V}$, $R_{CS}=1.4\Omega$, $L=0.20\text{mH}$, $t_{DLY1}=0.20\mu\text{s}$ and $t_{DLY2}=0.40\mu\text{s}$,

$$I_{LED} = \frac{1}{2} \times \left(\frac{0.7}{1.4} + \frac{100-60}{0.2 \times 10^{-3}} \times 0.20 \times 10^{-6} - \frac{60}{0.2 \times 10^{-3}} \times 0.40 \times 10^{-6} \right) \times 10^3 = 210 \quad [\text{mA}]$$

[The LED Current's error by t_{DLY1} and t_{DLY2}]

The LED current is shifted by the fluctuation of t_{DLY1} and t_{DLY2} . t_{DLY1} and t_{DLY2} , which are decided by the inductance(L), the MOSFET(M1), the Diode(D) and the ZT capacitance(C1), affects the LED current.

When the fluctuation of the t_{DLY1} is +10% from the setting example(in other words, $t_{DLY1}=0.22\mu\text{s}$), I_{LED}' is calculated as follows.

$$I_{LED}' = \frac{1}{2} \times \left(\frac{0.7}{1.4} + \frac{100-60}{0.2 \times 10^{-3}} \times 0.22 \times 10^{-6} - \frac{60}{0.2 \times 10^{-3}} \times 0.40 \times 10^{-6} \right) \times 10^3 = 212 \quad [\text{mA}]$$

Thus, the ratio of difference is

$$\Delta I_{LED} = \frac{I_{LED}' - I_{LED}}{I_{LED}} = \frac{212 - 210}{210} \times 100 = +0.95 \quad [\%]$$

Timing Chart(QR)

If there is no description, the mentioned values are typical value.

1. Starting Up(1)

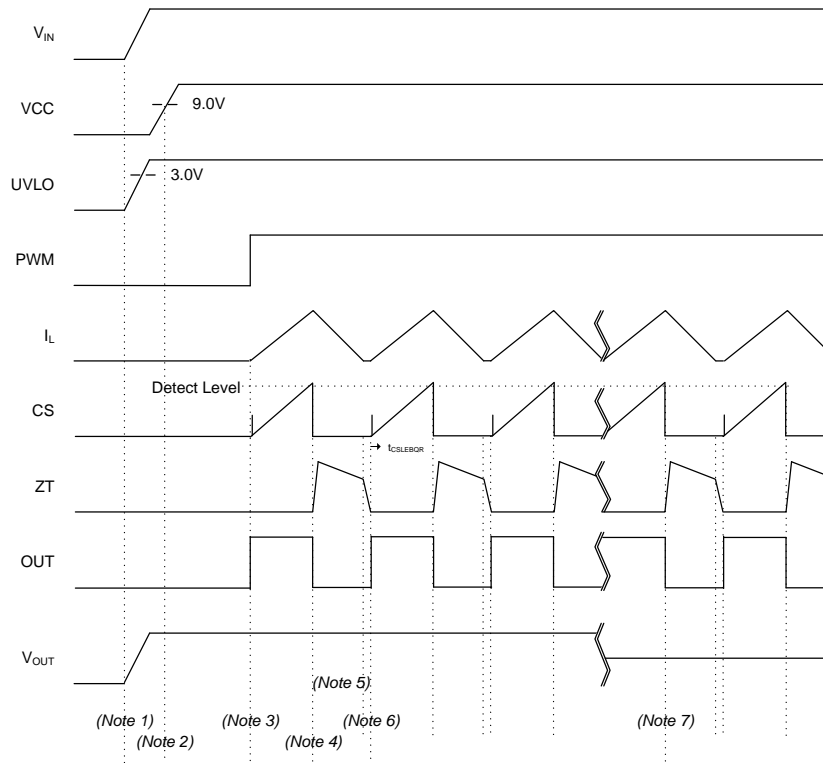

Figure 5. Starting Up Waveform(1)

(Note 1)...It is recommended that V_{IN} turns on firstly and turns off lastly on the input sequence.

(Note 2)...The IC starts when $V_{CC} > 9.0V$.

(Note 3)...After 524ms when $V_{CC} > 9.0V$, OUT pin switching is enabled with PWM=H.

In the figure, the PWM duty is 100%. The IC becomes the start completion when it becomes OUT=H, and all protection becomes detectable.

(Note 4)...When the CS pin reaches the detection level, it outputs OUT=L.

(Note 5)...When the coil current decreases to zero ($I_L=0mA$), ZT suddenly decreases. When ZT reaches the detection level, it outputs OUT=H.

(Note 6)...The CS switching noise is masked during Leading Edge Blank time $t_{CSLEBQR}$ (0.25 μs), which counts from OUT=H. During this term, the MOSFET is not turned off, even if CS voltage become detection level or more.

(Note 7)...After C_{OUT} is charged and V_{OUT} decreases, LED current flows.

Timing Chart(QR) - continued

2. Starting Up(2)

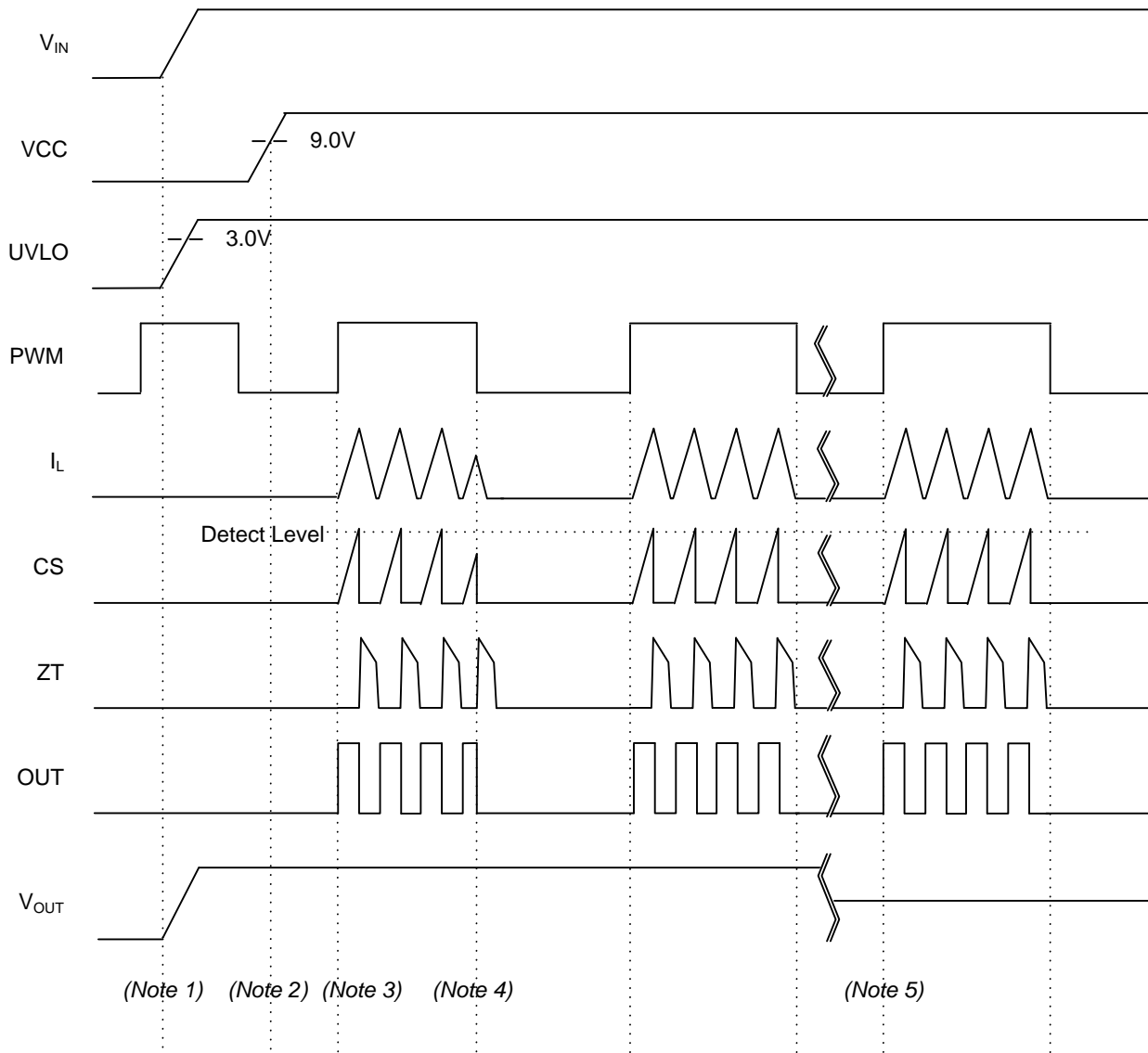

Figure 6. Starting Up Waveform(2)

(Note 1)... It is recommended that V_{IN} turns on firstly and turns off lastly on the input sequence.

(Note 2)...The IC starts when $V_{CC} > 9.0V$.

(Note 3)...With the dimming signal input to PWM, after 524ms when $V_{CC} > 9.0V$, OUT pin switching is enabled with PWM=H. The IC becomes the start completion when it becomes OUT=H, and all protection becomes detectable.

(Note 4)...PWM=L stops the switching operation.

(Note 5)...After C_{OUT} is charged and V_{OUT} decreases, LED current flows.

Timing Chart(QR) - continued

3. Maximum Frequency Operation

As for the resonance frequency, the IC works maximum frequency QR(f_{MAXQR}) 800kHz(Min) or less. It prevents from increasing temperature because of the fast switching frequency. In this operation, the LED current is lower than the setting value, because the interval of $I_L=0mA$ is longer than expected.

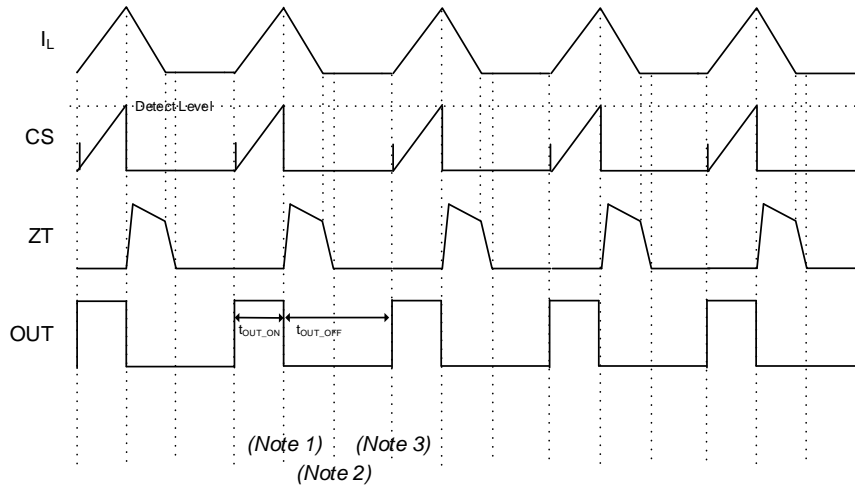

Figure 7. Maximum Frequency Operation Waveform

- (Note 1)...CS reached the detection level. It outputs OUT=L.
- (Note 2)...ZT reached the detection level, but cannot become next OUT=H when the operational frequency is too fast.
- (Note 3)...After the certain interval, it outputs OUT=H. In this case,

$$\frac{1}{t_{OUT_ON} + t_{OUT_OFF}} = f_{MAXQR}$$

Here, $f_{MAXQR}=800kHz(\text{Min})$.

4. Maximum On Time Operation

As for the ON time(t_{OUT_ON}), the IC works $t_{OUT_ON} < t_{MAXON}(20\mu s)$. It limits the current increasing speed of MOSFET and others at abnormal state.

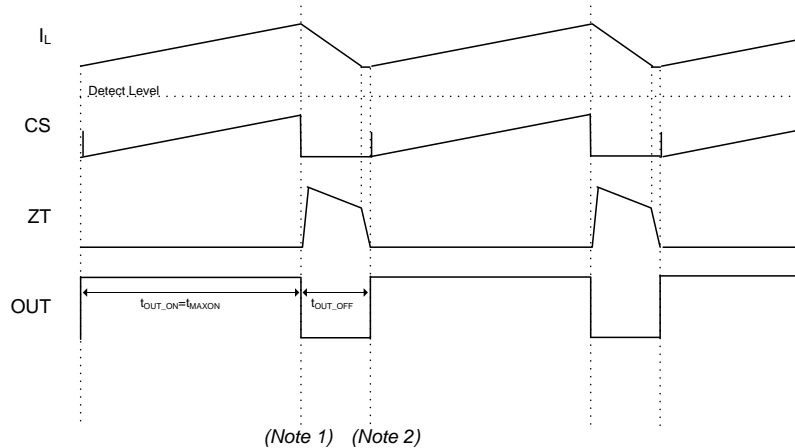

Figure 8. Maximum On Time Operation Waveform

- (Note 1)...CS does not reach the detection level, but it outputs OUT=L because of $t_{OUT_ON}=t_{MAXON}$.
- (Note 2)...ZT reached the detection level, it outputs OUT=H.

Timing Chart(QR) - continued

5. ZT Trigger Time-out Operation

When the operation is out of its resonance, for example, ZT always keeps L because of the abnormality of the external parts around IC, this function turns on MOS with the constant interval t_{ZTOUT} (25 μ s).

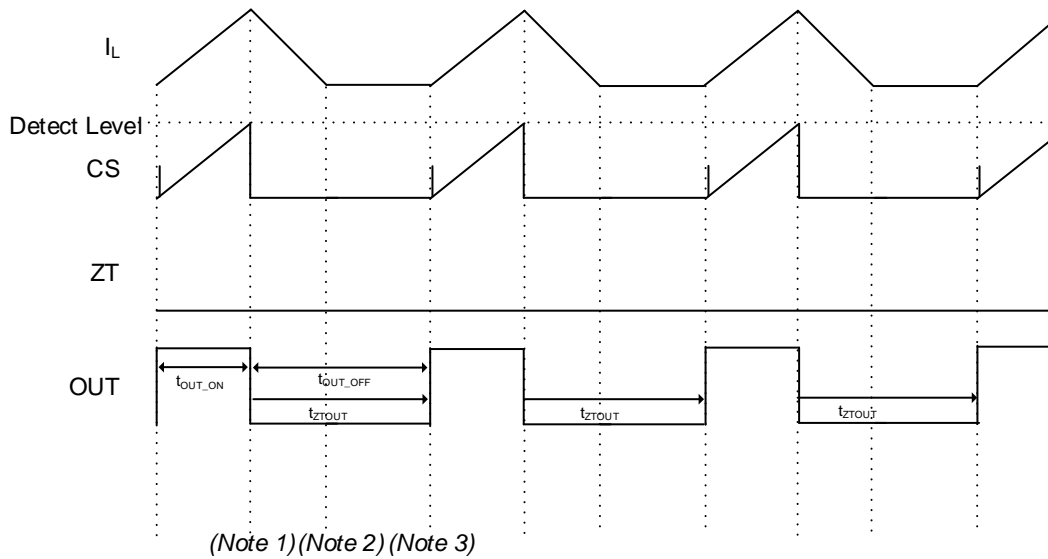

Figure 9. ZT Trigger Time-out Operation Waveform

(Note 1)...CS reached the detection level, it outputs OUT=L.

(Note 2)...Because ZT is always L, it cannot be output next OUT=H.

(Note 3)...It outputs OUT=H forcibly, when it does not change to OUT=H even if it passes for a certain period t_{ZTOUT} (25 μ s), after it becomes OUT=L. The time measurement of t_{ZTOUT} is no relation to the PWM logic.

Timing Chart(QR) - continued

6. CS OVP

This is the protection function which stops once and restarts after 524ms, when the high voltage input into the CS pin because of the abnormality of the external parts around IC.

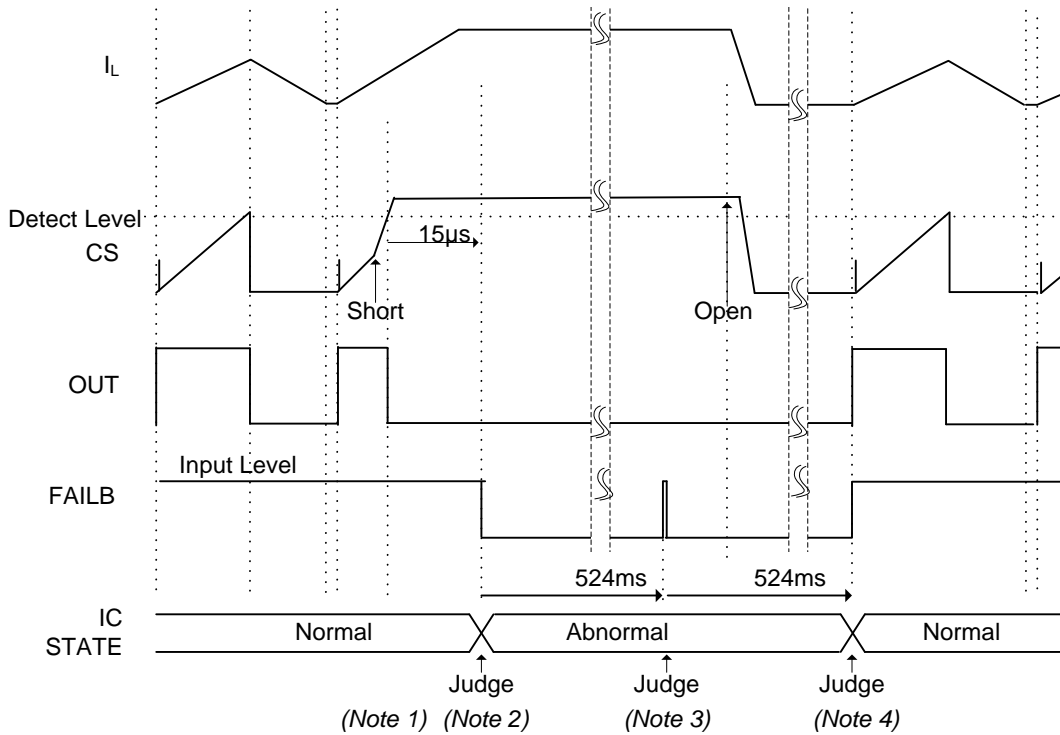

Figure 10. CS OVP Operation Waveform(1)

- (Note 1)...It is the example of the IC around parts short circuit which occurred by the high voltage being input into CS pin. If CS exceeds the current detection voltage(V_{CSOVP}), it outputs $OUT=L$.
- (Note 2)...If $V_{CS} > V_{CSOVP}$ continues 15µs or more nevertheless $OUT=L$, the state is judged as abnormal and the operation is stopped for 524ms.
- (Note 3)...After 524ms, it is judge again. In the figure, because of $V_{CS} > V_{CSOVP}$, the abnormality still keeps and stops the operation.
- (Note 4)...As a result of judgment again, an abnormal state is released because of $V_{CS} < V_{CSOVP}$ in this figure. The operation is restarted.

Timing Chart(QR) - continued

7. CS LOW

This is the protection function which stops once and restarts after 524ms, when the CS pin does not reach the detect level, because of the abnormality of the external parts around IC.

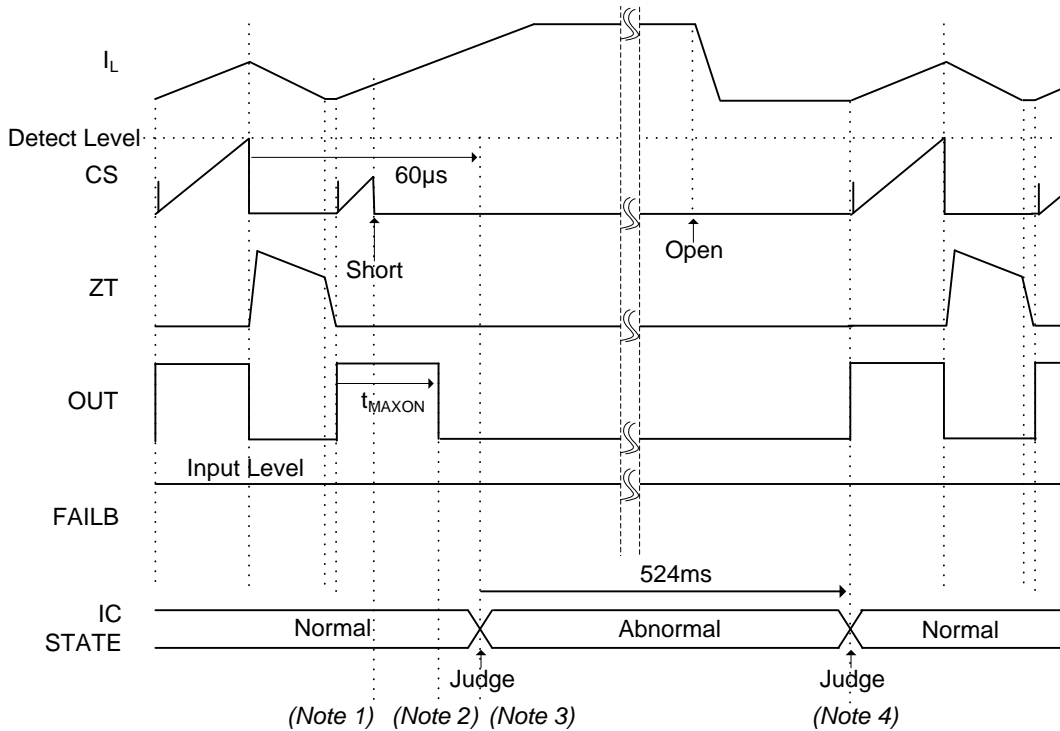

Figure 11. CS LOW Operation Waveform(1)

(Note 1)...It is the example of the short circuit of the around IC parts when the CS pin does not increase.

(Note 2)...When CS does not reach the current detection voltage(V_{CSOVP}) during maximum ON width $t_{MAXON}(20\mu s)$ from $OUT=H$, it outputs $OUT=L$.

(Note 3)...The state which CS does not reach the current detection voltage(V_{CSOVP}) continues 60µs or more, the state is judged as abnormal and the operation is stopped for 524ms.

(Note 4)...It is judged again. The operation is restarted.

Timing Chart(QR) - continued

8. CS LEB DET

This is the protection function which stops once and restarts after 524ms, when the state that the CS pin rises rapidly continues, because of the abnormality of the external parts around IC.

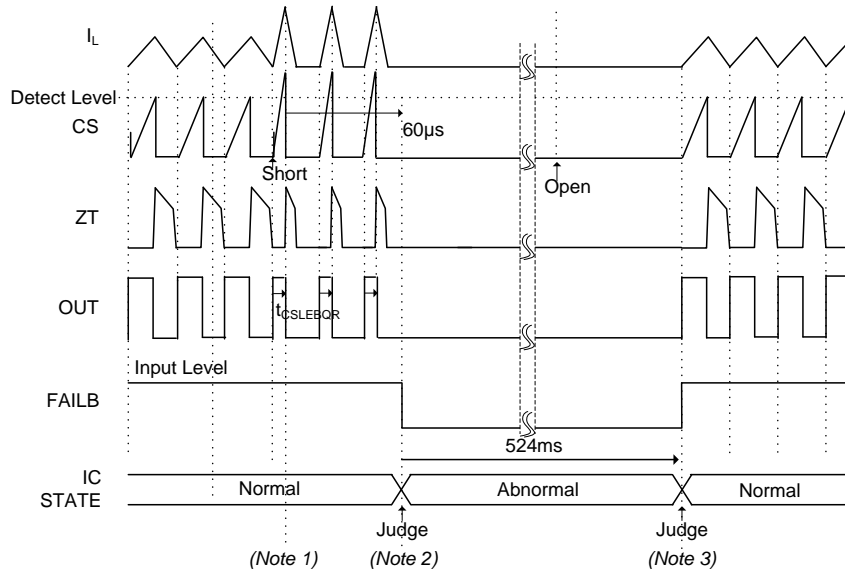

Figure 12. CS LEB DET Operation Waveform(1)

(Note 1)...It is the example of the short circuit of the around IC parts when the on-time of the MOSFET is $t_{CSLEBQR}(0.25\mu s)$ by the rapid rise of CS pin. The on-time of the MOSFET is not shorter than $t_{CSLEBQR}$.

(Note 2)...The state which (Note 1) continues 60µs, the state is judged as abnormal and the operation is stopped for 524ms.

(Note 3)...It is judged again. The operation is restarted.

9. UVLO

This is the protection function which stops once and restarts after 524ms, when the state that low V_{IN} voltage continues.

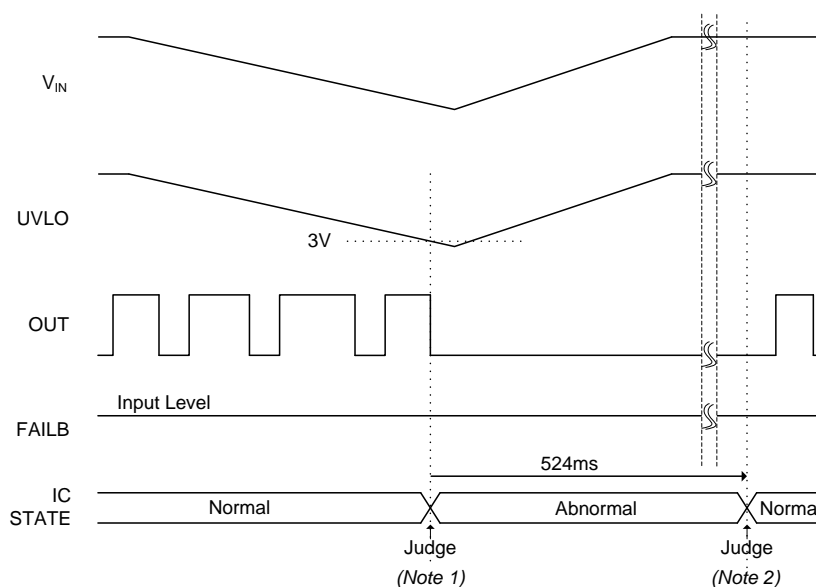

Figure 13. UVLO Operation Waveform(1)

(Note 1)...If $V_{UVLO} < 3V$ is detected, the state is judged as abnormal and the operation is stopped for 524ms.

(Note 2)...It is judged again. The operation is restarted.

Parts Setting Example(CCM)

If there is no description, the mentioned values are typical value.
Following symbol are shown in the right diagram.

The IC operates with constant frequency and average current control at CCM selected(SEL=L).

The frequency(f_{CTCCM}) is set by resistance(R_{RT}) connected to the RT pin.

[1]...During M1=ON, as the coil(L) voltage of its both side can approximate $V_{IN}-V_{LED}$, the slope of I_L ; Slope $_{IL_ON}$ is

$$Slope_{IL_ON} = \frac{V_{IN} - V_{LED}}{L}$$

[2]...During M1=OFF, as the coil(L) voltage of its both side can approximate V_{LED} , the slope of I_L ; Slope $_{IL_OFF}$ is

$$Slope_{IL_OFF} = \frac{V_{LED}}{L}$$

The equation can be expressed above.

[3]...OUT=H is output by the set frequency(f_{CTCCM}).

On Time($t_{OUT_ON(CCM)}$) and Off Time($t_{OUT_OFF(CCM)}$) can be roughly estimated with

$$t_{OUT_ON(CCM)} = \frac{1}{f_{CTCCM}} \times \frac{V_{LED}}{V_{IN}}, t_{OUT_OFF(CCM)} = \frac{1}{f_{CTCCM}} \times \left(1 - \frac{V_{LED}}{V_{IN}}\right)$$

C_{OUT} smoothies an LED current. Ripple current of the LED becomes large with small C_{OUT} . When large C_{OUT} is used, the response of an LED current is slow at PWM dimming. Rg can set the switching response speed of M1.

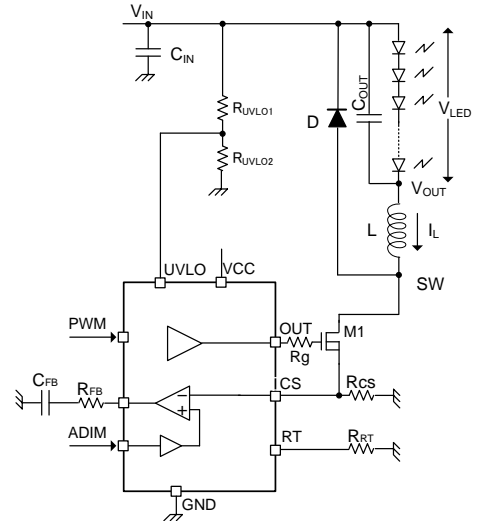

Figure 14. Application Circuits

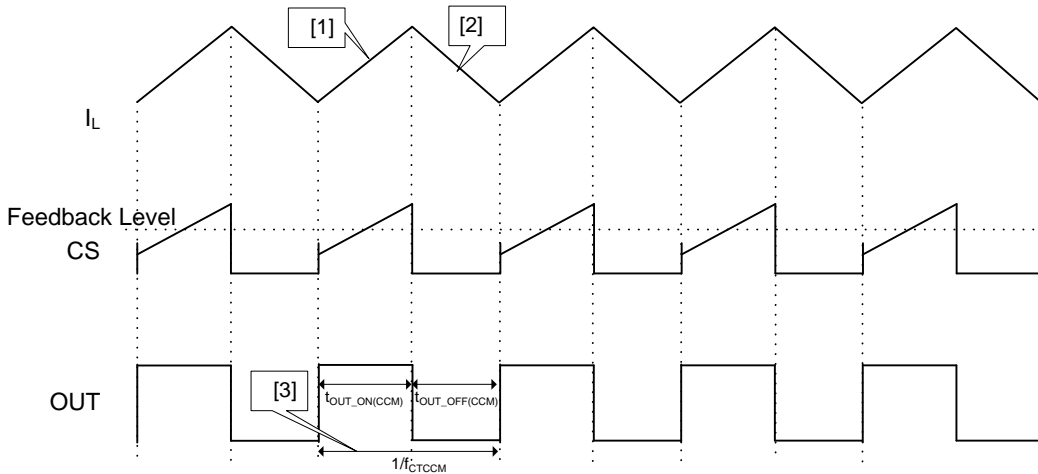

Figure 15. Dimming Waveform

LED Current Setting(CCM)

If there is no description, the mentioned values are typical value.

The LED current(I_{LED}) is expressed as follows.

$$I_{LED} = \frac{V_{CSCCM}}{R_{CS}} \quad [\text{mA}]$$

where:

$$V_{CSCCM} = V_{ADIM} \times 0.35 \quad [\text{V}] \quad (V_{ADIM} \leq 1.6\text{V}, SEL = L, DUTYON = H)$$

$$V_{CSCCM} = 0.560 \quad [\text{V}] \quad (V_{ADIM} > 1.6\text{V}, SEL = L, DUTYON = H)$$

Timing Chart(CCM)

If there is no description, the mentioned values are typical value.

1. Starting Up(1)

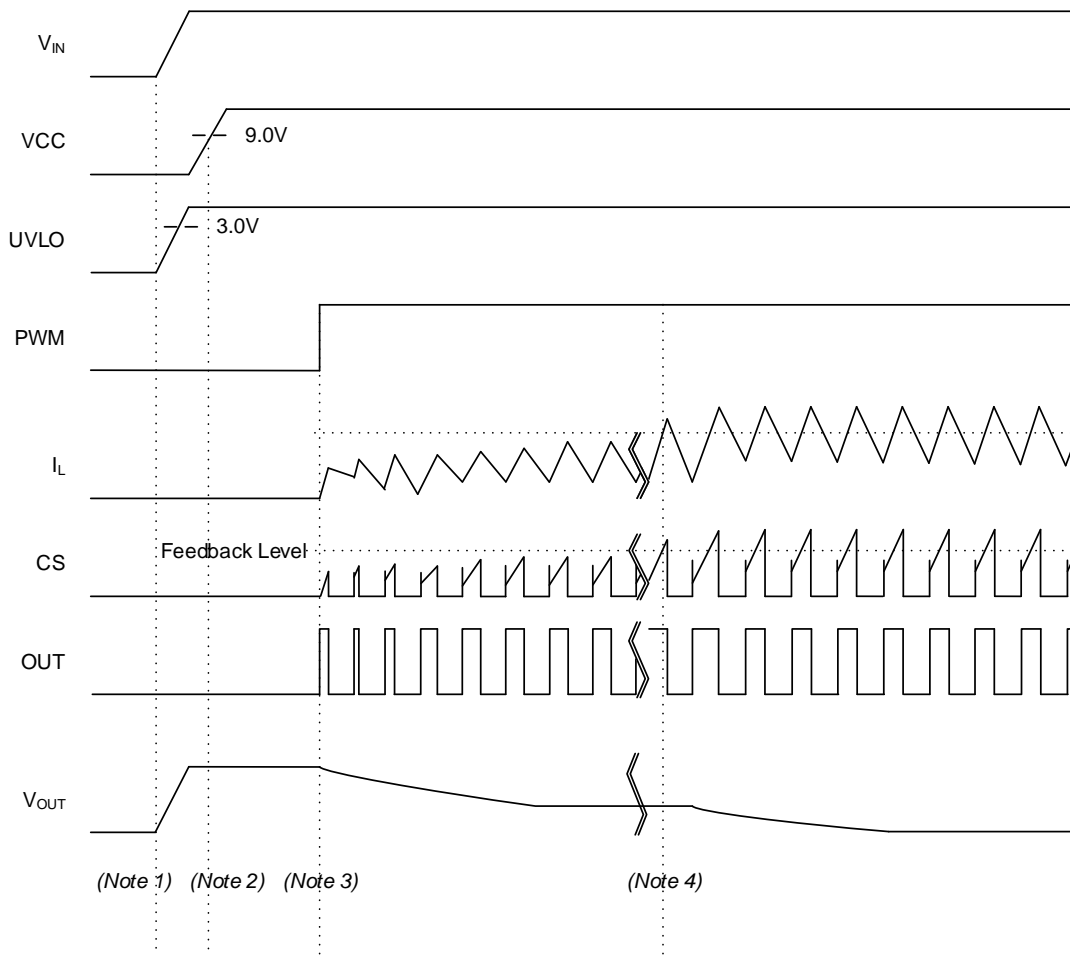

Figure 16. Starting Up Waveform(3)

(Note 1)...It is recommended that V_{IN} turns on firstly and turns off lastly on the input sequence.

(Note 2)...The IC starts when $V_{CC} > 9.0\text{V}$.

(Note 3)...After 524ms when $V_{CC} > 9.0\text{V}$, charge of the FB pin starts and switching operation becomes possible with $\text{PWM}=\text{H}$. In the figure, then it is $\text{PWM}=100\%$.

(Note 4)...The IC becomes the start completion when the CS pin voltage reaches Feedback Level(or $V_{FB} > 3.7\text{V}$), and all protection becomes detectable.

Timing Chart(CCM) - continued

2. Starting Up(2)

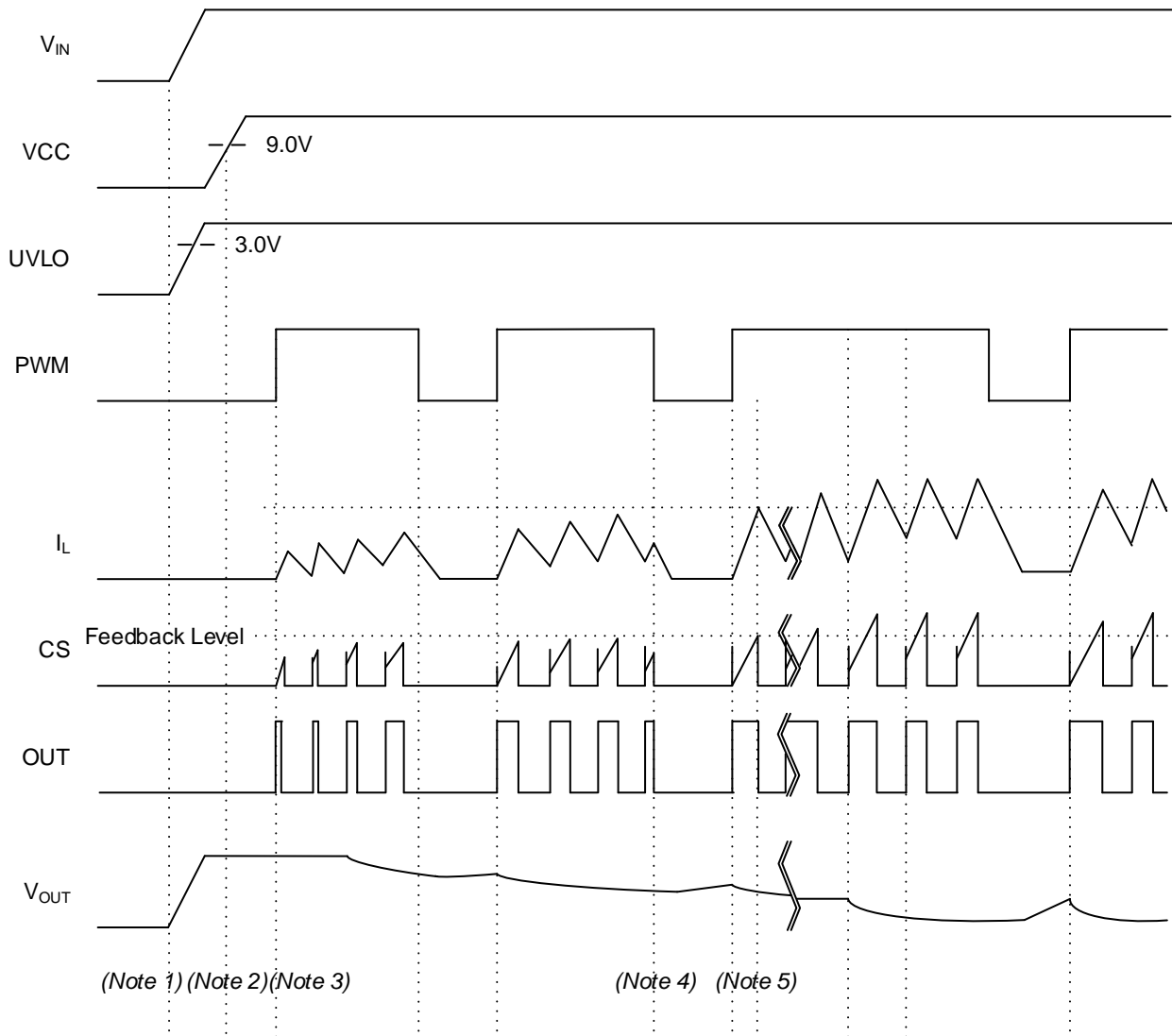

Figure 17. Starting Up Waveform(4)

(Note 1)...It is recommended that V_{IN} turns on firstly and turns off lastly on the input sequence.

(Note 2)...The IC starts when $V_{CC} > 9.0V$.

(Note 3)...With the dimming signal input to PWM, after 524ms when $V_{CC} > 9.0V$, switching operation becomes possible with PWM=H.

(Note 4)...Switching operation stops when PWM=L.

(Note 5)...The IC becomes the start completion when the CS pin voltage reaches Feedback Level(or $V_{FB} > 3.7V$), and all protection becomes detectable.

Timing Chart(CCM) - continued

3. CS OVP

This is the protection function which stops once and restarts after 524ms, when the high voltage was input into the CS pin because of the abnormality of the external parts around IC.

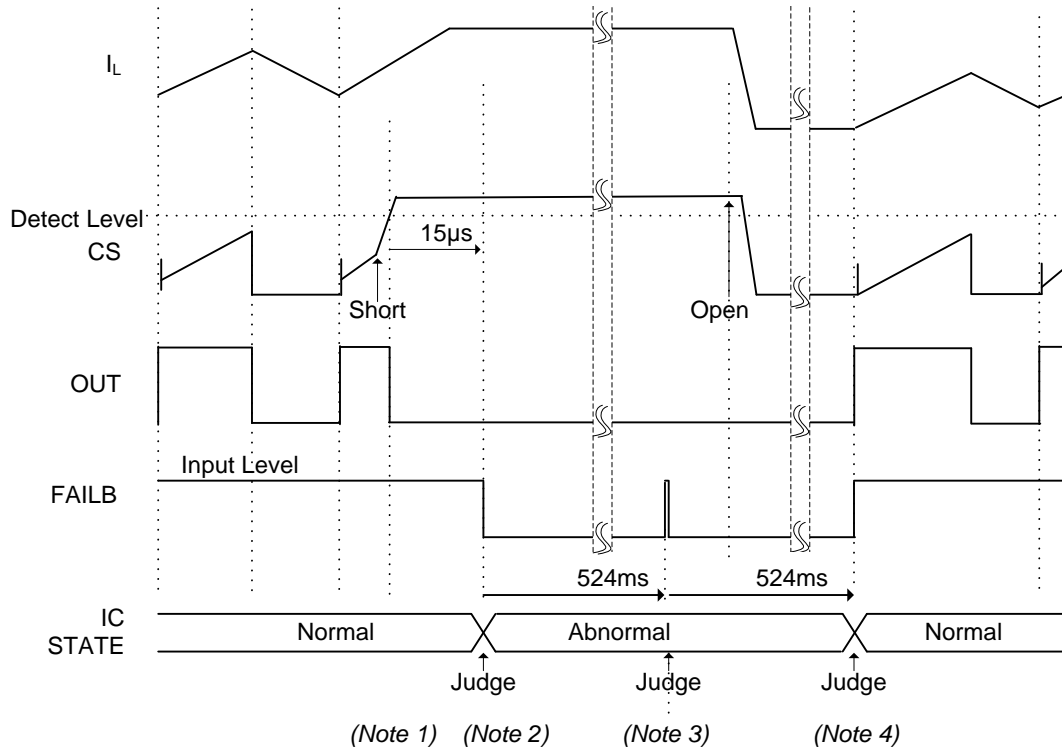

Figure 18. CS OVP Operation Waveform(2)

(Note 1)...It is the example of the IC around parts short circuit which occurred by the high voltage being input into CS pin. If CS exceeds the current detection voltage(V_{CSOVP}), it outputs $OUT=L$.

(Note 2)...If $V_{CS} > V_{CSOVP}$ continues $15\mu s$ or more nevertheless $OUT=L$, the state is judged as abnormal and the operation is stopped for $524ms$.

(Note 3)...After $524ms$, it is judged again. In the figure, considering $V_{CS} > V_{CSOVP}$, the abnormality still keeps and stops the operation.

(Note 4)...As a result of judgment again, an abnormal state is released because of $V_{CS} < V_{CSOVP}$ in this figure. The operation is restarted.

Timing Chart(CCM) - continued

4. CS LOW

This is the protection function which stops once and restarts after 524ms, when the CS pin does not reach the detect level, because of the abnormality of the external parts around IC.

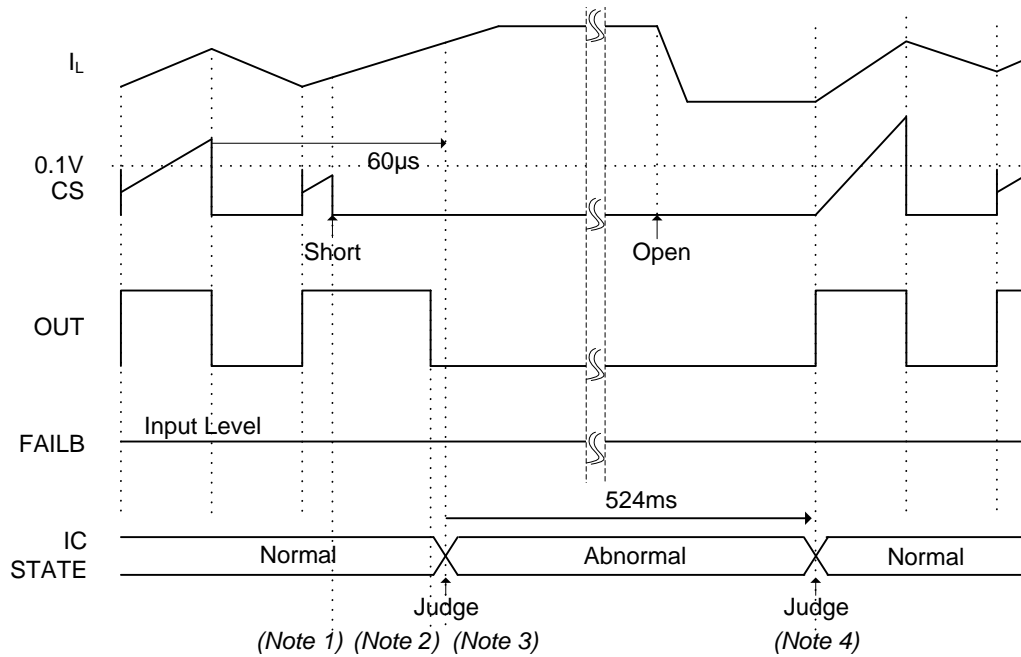

Figure 19. CS LOW Operation Waveform(2)

(Note 1)...It is the example of the short circuit of the around IC parts when the CS pin does not increase.

(Note 2)...OUT=H lasts up to OUT Pin Maximum Duty CCM(D_{MAXCCM}) or MAX ON width(t_{MAXON}) and becomes OUT=L.

(Note 3)...The state which CS does not reach the CS LOW(CCM) voltage 0.1V continues 60μs or more, the state is judged as abnormal and the operation is stopped for 524ms.

(Note 4)...It is judged again. The operation is restarted.

Timing Chart(CCM) - continued

5. CS LEB DET

This is the protection function which stops once and restarts after 524ms, when the state that the CS pin rises rapidly continues, because of the abnormality of the external parts around IC.

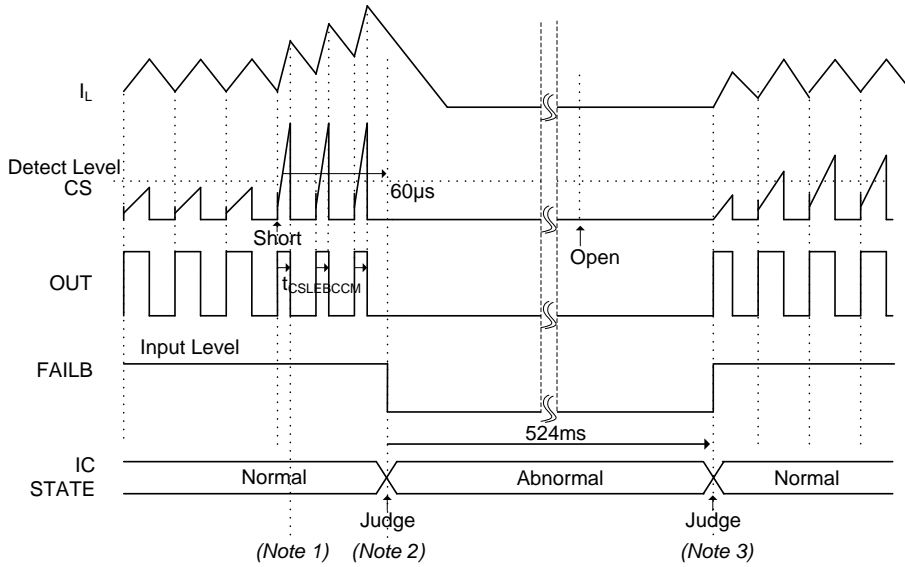

Figure 20. LEB DET Operation Waveform(2)

(Note 1)...It is the example of the short circuit of the around IC parts when the on-time of the MOSFET is $t_{CSLEBCCM}(0.50\mu s)$ by the rapid rise of CS pin. The on-time of the MOSFET is not shorter than $t_{CSLEBCCM}$.

(Note 2)...The state which (Note 1) continues 60µs, the state is judged as abnormal and the operation is stopped for 524ms.

(Note 3)...It is judged again. The operation is restarted.

6. UVLO

This is the protection function which stops once and restarts after 524ms, when the state that low V_{IN} voltage continues.

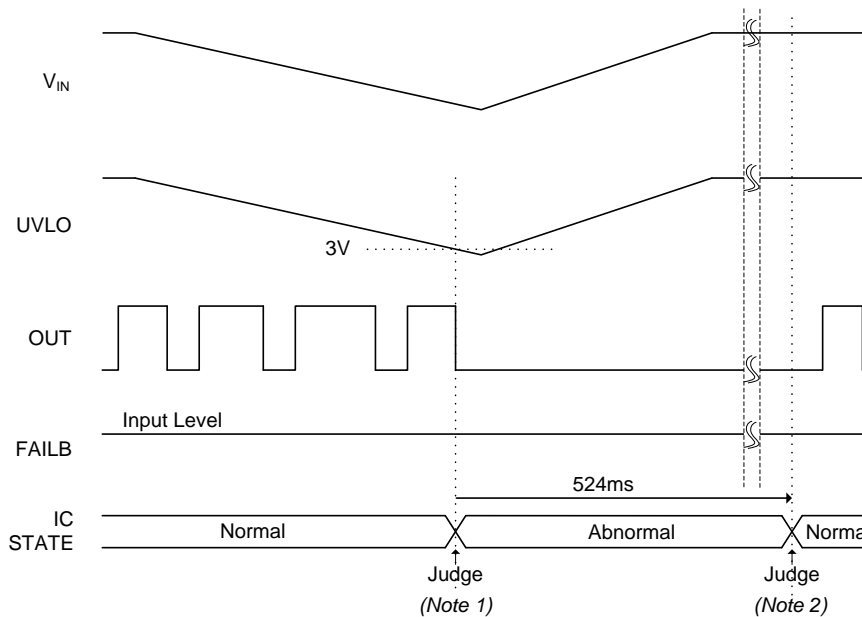
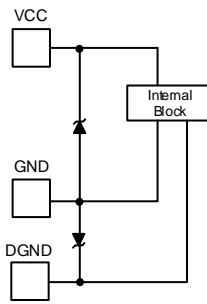
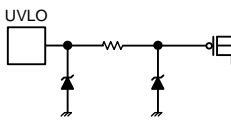
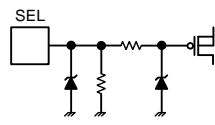
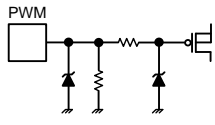
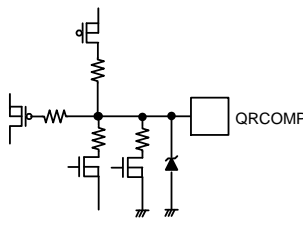
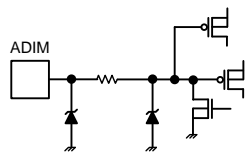
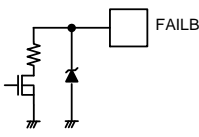
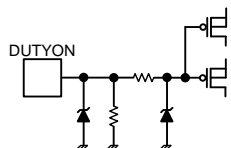
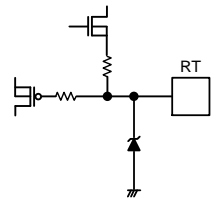
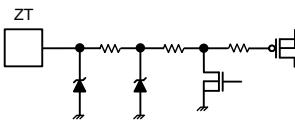
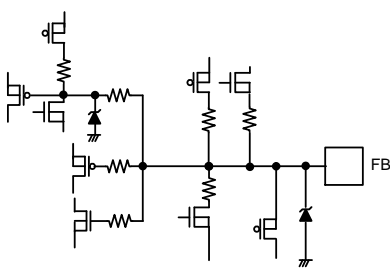
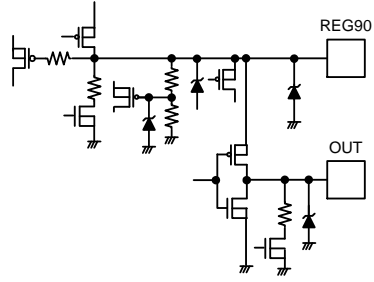
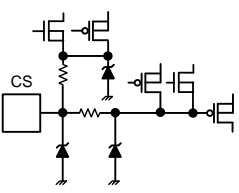

Figure 21. UVLO Operation Waveform(2)

(Note 1)...If $V_{UVLO} < 3V$ is detected, the state is judged as abnormal and the operation is stopped for 524ms.

(Note 2)...It is judged again. The operation is restarted.

I/O Equivalent Circuits

<p>Pin1: VCC, Pin12: DGND, Pin13: GND</p> 	<p>Pin2: UVLO</p> 	<p>Pin3: SEL</p> 
<p>Pin4: PWM</p> 	<p>Pin5: QRCOMP</p> 	<p>Pin6: ADIM</p> 
<p>Pin7: FAILB</p> 	<p>Pin8: DUTYON</p> 	<p>Pin9: RT</p> 
<p>Pin10: ZT</p> 	<p>Pin11: FB</p> 	<p>Pin14: OUT, Pin16: REG90</p> 
<p>Pin15: CS</p> 		

Operational Notes

1. Reverse Connection of Power Supply

Connecting the power supply in reverse polarity can damage the IC. Take precautions against reverse polarity when connecting the power supply, such as mounting an external diode between the power supply and the IC's power supply pins.

2. Power Supply Lines

Design the PCB layout pattern to provide low impedance supply lines. Furthermore, connect a capacitor to ground at all power supply pins. Consider the effect of temperature and aging on the capacitance value when using electrolytic capacitors.

3. Ground Voltage

Ensure that no pins are at a voltage below that of the ground pin at any time, even during transient condition.

4. Ground Wiring Pattern

When using both small-signal and large-current ground traces, the two ground traces should be routed separately but connected to a single ground at the reference point of the application board to avoid fluctuations in the small-signal ground caused by large currents. Also ensure that the ground traces of external components do not cause variations on the ground voltage. The ground lines must be as short and thick as possible to reduce line impedance.

5. Recommended Operating Conditions

The function and operation of the IC are guaranteed within the range specified by the recommended operating conditions. The characteristic values are guaranteed only under the conditions of each item specified by the electrical characteristics.

6. Inrush Current

When power is first supplied to the IC, it is possible that the internal logic may be unstable and inrush current may flow instantaneously due to the internal powering sequence and delays, especially if the IC has more than one power supply. Therefore, give special consideration to power coupling capacitance, power wiring, width of ground wiring, and routing of connections.

7. Operation Under Strong Electromagnetic Field

Operating the IC in the presence of a strong electromagnetic field may cause the IC to malfunction.

8. Testing on Application Boards

When testing the IC on an application board, connecting a capacitor directly to a low-impedance output pin may subject the IC to stress. Always discharge capacitors completely after each process or step. The IC's power supply should always be turned off completely before connecting or removing it from the test setup during the inspection process. To prevent damage from static discharge, ground the IC during assembly and use similar precautions during transport and storage.

9. Inter-pin Short and Mounting Errors

Ensure that the direction and position are correct when mounting the IC on the PCB. Incorrect mounting may result in damaging the IC. Avoid nearby pins being shorted to each other especially to ground, power supply and output pin. Inter-pin shorts could be due to many reasons such as metal particles, water droplets (in very humid environment) and unintentional solder bridge deposited in between pins during assembly to name a few.

10. Unused Input Pins

Input pins of an IC are often connected to the gate of a MOS transistor. The gate has extremely high impedance and extremely low capacitance. If left unconnected, the electric field from the outside can easily charge it. The small charge acquired in this way is enough to produce a significant effect on the conduction through the transistor and cause unexpected operation of the IC. So unless otherwise specified, unused input pins should be connected to the power supply or ground line.

Operational Notes - continued

11. Regarding the Input Pin of the IC

This monolithic IC contains P+ isolation and P substrate layers between adjacent elements in order to keep them isolated. P-N junctions are formed at the intersection of the P layers with the N layers of other elements, creating a parasitic diode or transistor. For example (refer to figure below):

When $GND > Pin A$ and $GND > Pin B$, the P-N junction operates as a parasitic diode.

When $GND > Pin B$, the P-N junction operates as a parasitic transistor.

Parasitic diodes inevitably occur in the structure of the IC. The operation of parasitic diodes can result in mutual interference among circuits, operational faults, or physical damage. Therefore, conditions that cause these diodes to operate, such as applying a voltage lower than the GND voltage to an input pin (and thus to the P substrate) should be avoided.

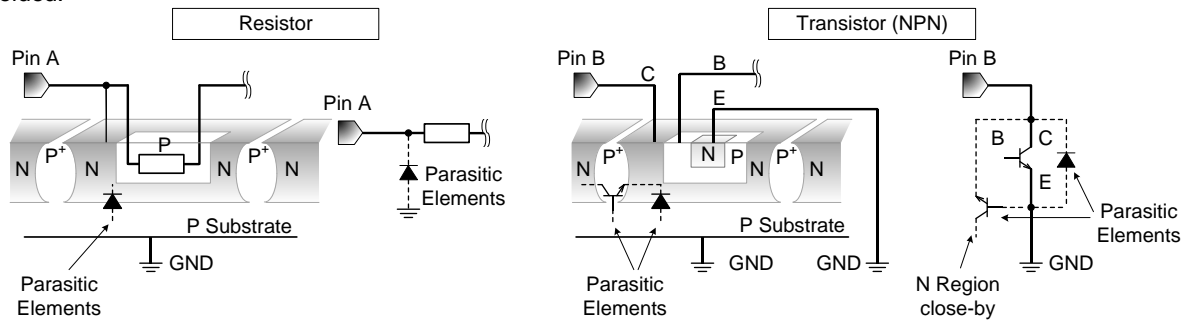

Figure 22. Example of monolithic IC Structure

12. Ceramic Capacitor

When using a ceramic capacitor, determine a capacitance value considering the change of capacitance with temperature and the decrease in nominal capacitance due to DC bias and others.

13. Area of Safe Operation (ASO)

Operate the IC such that the output voltage, output current, and the maximum junction temperature rating are all within the Area of Safe Operation (ASO).

14. Thermal Shutdown Circuit(TSD)

This IC has a built-in thermal shutdown circuit that prevents heat damage to the IC. Normal operation should always be within the IC's maximum junction temperature rating. If however the rating is exceeded for a continued period, the junction temperature (T_j) will rise which will activate the TSD circuit that will turn OFF power output pins. When the T_j falls below the TSD threshold, the circuits are automatically restored to normal operation.

Note that the TSD circuit operates in a situation that exceeds the absolute maximum ratings and therefore, under no circumstances, should the TSD circuit be used in a set design or for any purpose other than protecting the IC from heat damage.

15. Over Current Protection Circuit (OCP)

This IC incorporates an integrated overcurrent protection circuit that is activated when the load is shorted. This protection circuit is effective in preventing damage due to sudden and unexpected incidents. However, the IC should not be used in applications characterized by continuous operation or transitioning of the protection circuit.

Ordering Information

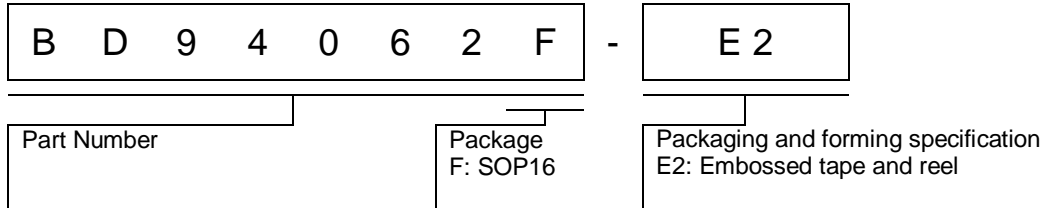

Marking Diagrams

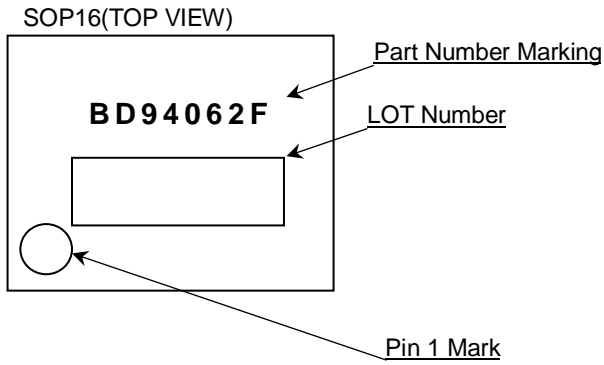

Physical Dimension and Packing Information

Package Name	SOP16
--------------	-------

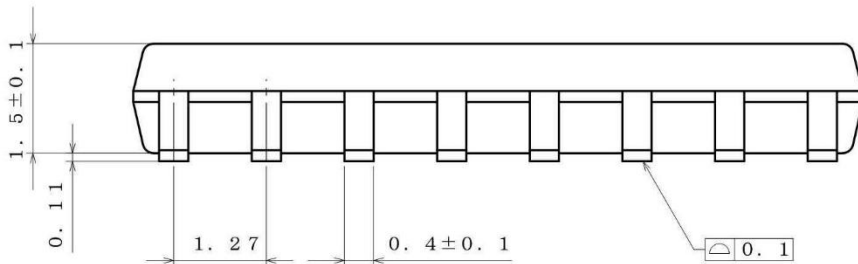
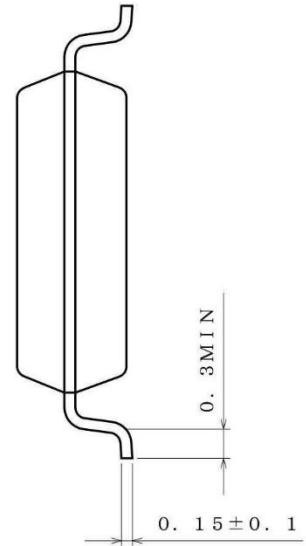
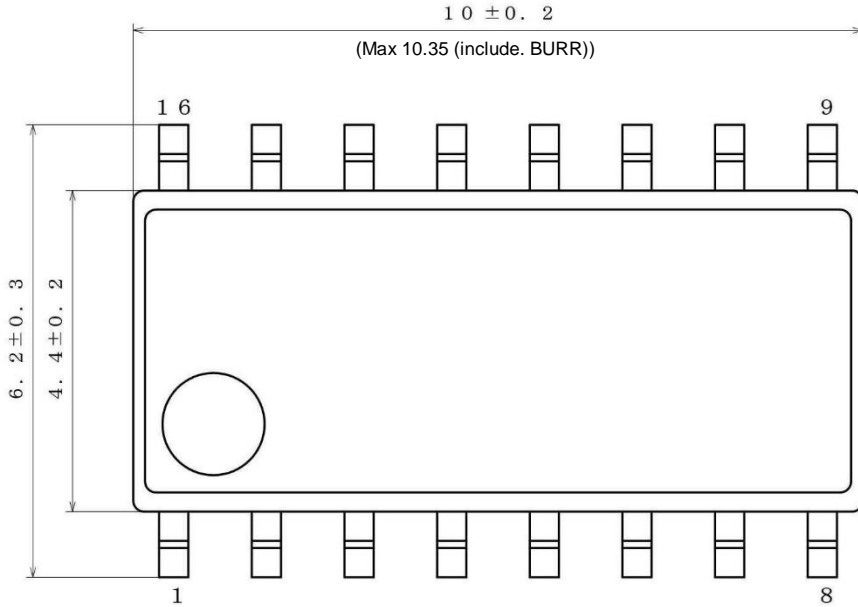

(UNIT: mm)
 PKG: SOP16
 Drawing No.: EX114-5001

<Tape and Reel information>

Tape	Embossed carrier tape
Quantity	2500pcs
Direction of feed	E2 (The direction is the 1pin of product is at the upper left when you hold reel on the left hand and you pull out the tape on the right hand)

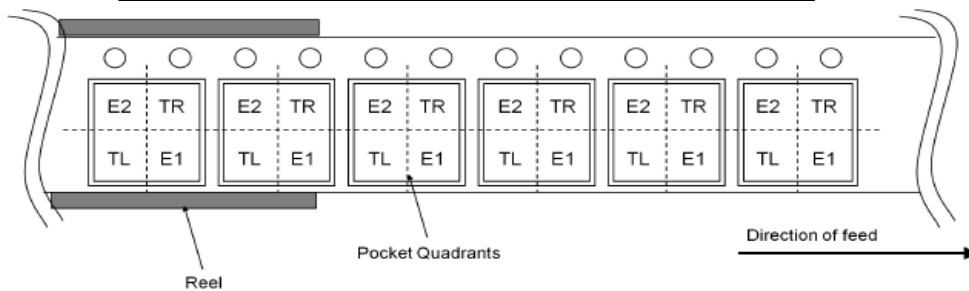

Revision History

Date	Rev.	Changes
26.Dec.2017	001	New Release
15.May.2018	002	Correction QRCOMP Pin Connection Capacitance The value of TYP is corrected.

Notice

Precaution on using ROHM Products

- Our Products are designed and manufactured for application in ordinary electronic equipment (such as AV equipment, OA equipment, telecommunication equipment, home electronic appliances, amusement equipment, etc.). If you intend to use our Products in devices requiring extremely high reliability (such as medical equipment ^(Note 1), transport equipment, traffic equipment, aircraft/spacecraft, nuclear power controllers, fuel controllers, car equipment including car accessories, safety devices, etc.) and whose malfunction or failure may cause loss of human life, bodily injury or serious damage to property ("Specific Applications"), please consult with the ROHM sales representative in advance. Unless otherwise agreed in writing by ROHM in advance, ROHM shall not be in any way responsible or liable for any damages, expenses or losses incurred by you or third parties arising from the use of any ROHM's Products for Specific Applications.

(Note1) Medical Equipment Classification of the Specific Applications

JAPAN	USA	EU	CHINA
CLASS III	CLASS III	CLASS II b	CLASS III
CLASS IV		CLASS III	

- ROHM designs and manufactures its Products subject to strict quality control system. However, semiconductor products can fail or malfunction at a certain rate. Please be sure to implement, at your own responsibilities, adequate safety measures including but not limited to fail-safe design against the physical injury, damage to any property, which a failure or malfunction of our Products may cause. The following are examples of safety measures:
 - Installation of protection circuits or other protective devices to improve system safety
 - Installation of redundant circuits to reduce the impact of single or multiple circuit failure
- Our Products are designed and manufactured for use under standard conditions and not under any special or extraordinary environments or conditions, as exemplified below. Accordingly, ROHM shall not be in any way responsible or liable for any damages, expenses or losses arising from the use of any ROHM's Products under any special or extraordinary environments or conditions. If you intend to use our Products under any special or extraordinary environments or conditions (as exemplified below), your independent verification and confirmation of product performance, reliability, etc. prior to use, must be necessary:
 - Use of our Products in any types of liquid, including water, oils, chemicals, and organic solvents
 - Use of our Products outdoors or in places where the Products are exposed to direct sunlight or dust
 - Use of our Products in places where the Products are exposed to sea wind or corrosive gases, including Cl₂, H₂S, NH₃, SO₂, and NO₂
 - Use of our Products in places where the Products are exposed to static electricity or electromagnetic waves
 - Use of our Products in proximity to heat-producing components, plastic cords, or other flammable items
 - Sealing or coating our Products with resin or other coating materials
 - Use of our Products without cleaning residue of flux (even if you use no-clean type fluxes, cleaning residue of flux is recommended); or Washing our Products by using water or water-soluble cleaning agents for cleaning residue after soldering
 - Use of the Products in places subject to dew condensation
- The Products are not subject to radiation-proof design.
- Please verify and confirm characteristics of the final or mounted products in using the Products.
- In particular, if a transient load (a large amount of load applied in a short period of time, such as pulse. is applied, confirmation of performance characteristics after on-board mounting is strongly recommended. Avoid applying power exceeding normal rated power; exceeding the power rating under steady-state loading condition may negatively affect product performance and reliability.
- De-rate Power Dissipation depending on ambient temperature. When used in sealed area, confirm that it is the use in the range that does not exceed the maximum junction temperature.
- Confirm that operation temperature is within the specified range described in the product specification.
- ROHM shall not be in any way responsible or liable for failure induced under deviant condition from what is defined in this document.

Precaution for Mounting / Circuit board design

- When a highly active halogenous (chlorine, bromine, etc.) flux is used, the residue of flux may negatively affect product performance and reliability.
- In principle, the reflow soldering method must be used on a surface-mount products, the flow soldering method must be used on a through hole mount products. If the flow soldering method is preferred on a surface-mount products, please consult with the ROHM representative in advance.

For details, please refer to ROHM Mounting specification

Precautions Regarding Application Examples and External Circuits

1. If change is made to the constant of an external circuit, please allow a sufficient margin considering variations of the characteristics of the Products and external components, including transient characteristics, as well as static characteristics.
2. You agree that application notes, reference designs, and associated data and information contained in this document are presented only as guidance for Products use. Therefore, in case you use such information, you are solely responsible for it and you must exercise your own independent verification and judgment in the use of such information contained in this document. ROHM shall not be in any way responsible or liable for any damages, expenses or losses incurred by you or third parties arising from the use of such information.

Precaution for Electrostatic

This Product is electrostatic sensitive product, which may be damaged due to electrostatic discharge. Please take proper caution in your manufacturing process and storage so that voltage exceeding the Products maximum rating will not be applied to Products. Please take special care under dry condition (e.g. Grounding of human body / equipment / solder iron, isolation from charged objects, setting of Ionizer, friction prevention and temperature / humidity control).

Precaution for Storage / Transportation

1. Product performance and soldered connections may deteriorate if the Products are stored in the places where:
 - [a] the Products are exposed to sea winds or corrosive gases, including Cl₂, H₂S, NH₃, SO₂, and NO₂
 - [b] the temperature or humidity exceeds those recommended by ROHM
 - [c] the Products are exposed to direct sunshine or condensation
 - [d] the Products are exposed to high Electrostatic
2. Even under ROHM recommended storage condition, solderability of products out of recommended storage time period may be degraded. It is strongly recommended to confirm solderability before using Products of which storage time is exceeding the recommended storage time period.
3. Store / transport cartons in the correct direction, which is indicated on a carton with a symbol. Otherwise bent leads may occur due to excessive stress applied when dropping of a carton.
4. Use Products within the specified time after opening a humidity barrier bag. Baking is required before using Products of which storage time is exceeding the recommended storage time period.

Precaution for Product Label

A two-dimensional barcode printed on ROHM Products label is for ROHM's internal use only.

Precaution for Disposition

When disposing Products please dispose them properly using an authorized industry waste company.

Precaution for Foreign Exchange and Foreign Trade act

Since concerned goods might be fallen under listed items of export control prescribed by Foreign exchange and Foreign trade act, please consult with ROHM in case of export.

Precaution Regarding Intellectual Property Rights

1. All information and data including but not limited to application example contained in this document is for reference only. ROHM does not warrant that foregoing information or data will not infringe any intellectual property rights or any other rights of any third party regarding such information or data.
2. ROHM shall not have any obligations where the claims, actions or demands arising from the combination of the Products with other articles such as components, circuits, systems or external equipment (including software).
3. No license, expressly or implied, is granted hereby under any intellectual property rights or other rights of ROHM or any third parties with respect to the Products or the information contained in this document. Provided, however, that ROHM will not assert its intellectual property rights or other rights against you or your customers to the extent necessary to manufacture or sell products containing the Products, subject to the terms and conditions herein.

Other Precaution

1. This document may not be reprinted or reproduced, in whole or in part, without prior written consent of ROHM.
2. The Products may not be disassembled, converted, modified, reproduced or otherwise changed without prior written consent of ROHM.
3. In no event shall you use in any way whatsoever the Products and the related technical information contained in the Products or this document for any military purposes, including but not limited to, the development of mass-destruction weapons.
4. The proper names of companies or products described in this document are trademarks or registered trademarks of ROHM, its affiliated companies or third parties.

General Precaution

1. Before you use our Products, you are requested to carefully read this document and fully understand its contents. ROHM shall not be in any way responsible or liable for failure, malfunction or accident arising from the use of any ROHM's Products against warning, caution or note contained in this document.
2. All information contained in this document is current as of the issuing date and subject to change without any prior notice. Before purchasing or using ROHM's Products, please confirm the latest information with a ROHM sales representative.
3. The information contained in this document is provided on an "as is" basis and ROHM does not warrant that all information contained in this document is accurate and/or error-free. ROHM shall not be in any way responsible or liable for any damages, expenses or losses incurred by you or third parties resulting from inaccuracy or errors of or concerning such information.