

4.5V to 18V Input, 3.0A Integrated MOSFET Single Synchronous Buck DC/DC Converter

BD9D322QWZ

General Description

BD9D322QWZ is a synchronous buck DC/DC converter with built-in low on-resistance power MOSFETs. This IC is capable of providing current up to 3A. The SLLM™ control provides excellent efficiency characteristics in light-load conditions which make the product ideal for equipment and devices that demand minimal standby power consumption. External phase compensation circuit is not necessary for it is a constant ON-Time control DC/DC converter with fast transient response.

Features

- Single Synchronous DC/DC Converter
- Constant ON-Time Control
- SLLM™ (Simple Light Load Mode) Control
- Over Current Protection
- Thermal Shutdown Protection
- Under Voltage Lockout Protection
- Adjustable Soft Start
- UMMP008Z2020 Package (Backside Heat Dissipation)

Applications

- Step-down Power Supply for DSPs, FPGAs, Microprocessors, etc.
- Set-top Box
- LCD TVs
- DVD / Blu-ray Player / Recorder
- POL Power Supply, etc.

Key Specifications

- Input Voltage Range: 4.5V to 18.0V
- Output Voltage Range: 0.765V to 7V
($V_{IN} \times 0.07$)V to ($V_{IN} \times 0.65$)V
- Output Current: 3A (Max)
- Switching Frequency: 700kHz (Typ)
- High-Side MOSFET ON-Resistance: 80mΩ (Typ)
- Low-Side MOSFET ON-Resistance: 50mΩ (Typ)
- Standby Current: 2μA (Typ)

Package

UMMP008Z2020

W(Typ) x D(Typ) x H(Max)

2.00mm x 2.00mm x 0.40mm

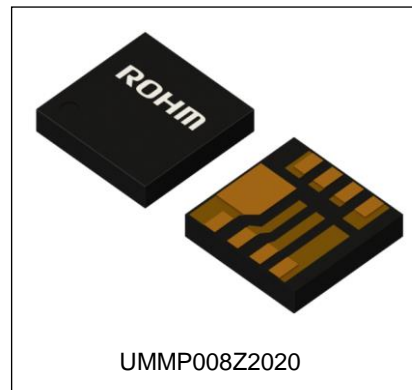

Typical Application Circuit

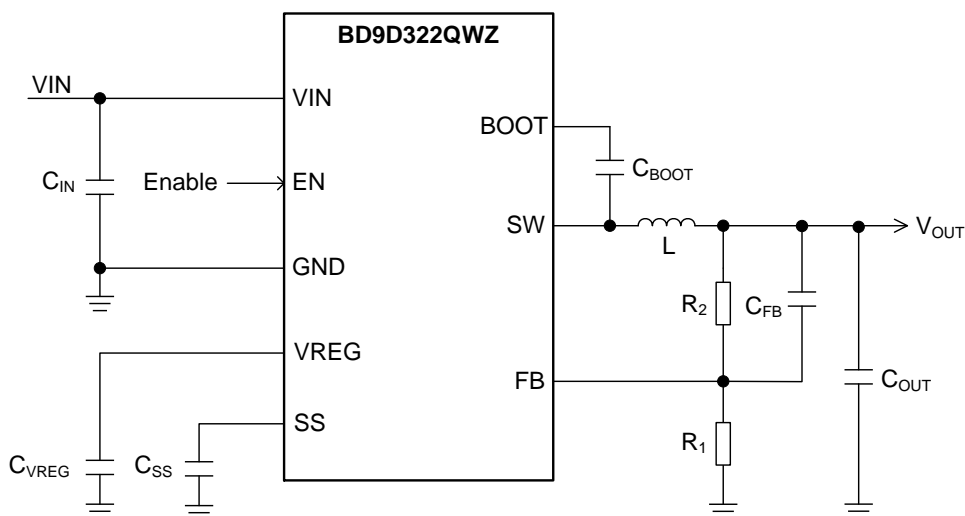

Figure 1. Typical Application Circuit

Pin Configuration

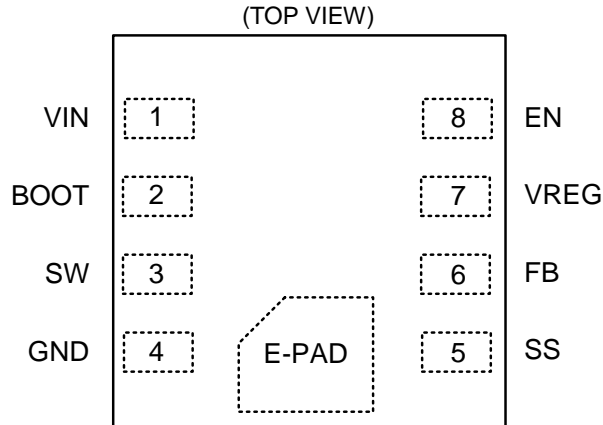

Figure 2. Pin Configuration

Pin Descriptions

Terminal No.	Symbol	Function
1	VIN	Power supply terminal for the switching regulator. Connecting 10 μ F and 0.1 μ F ceramic capacitors to ground are recommended.
2	BOOT	Terminal for bootstrap. Connect a bootstrap capacitor of 0.1 μ F between this terminal and SW terminal. The voltage of the bootstrap capacitor is the gate drive voltage of the High-Side MOSFET.
3	SW	Switch terminal. The SW terminal is connected to the source of the High-Side MOSFET and drain of the Low-Side MOSFET. Connect a bootstrap capacitor of 0.1 μ F between the SW terminal and BOOT terminal. In addition, connect an inductor considering the direct current superimposition characteristic.
4	GND	Ground terminal for the output stage of the switching regulator and the control circuit.
5	SS	Terminal for setting the soft start time. The rise time of the output voltage can be specified by connecting a capacitor to this terminal. Refer to page 29 for how to calculate the capacitance.
6	FB	An inverting input terminal for comparator which compares with reference voltage (V_{REF}). Refer to page 28 for how to calculate the resistances of the output voltage setting.
7	VREG	Internal power supply voltage terminal. Voltage of 5.25V (Typ) is outputted with more than 2.2V for EN terminal. Connect 1 μ F ceramic capacitor to ground.
8	EN	Enable terminal. Turning this terminal signal Low (0.3V or lower) forces the device to enter the shutdown mode. Turning this terminal signal High (2.2V or higher) enables the device. This terminal must be properly terminated.
-	E-PAD	Backside heat dissipation pad. Connecting to the PCB ground plane by using multiple via provides excellent heat dissipation characteristics.

Block Diagram

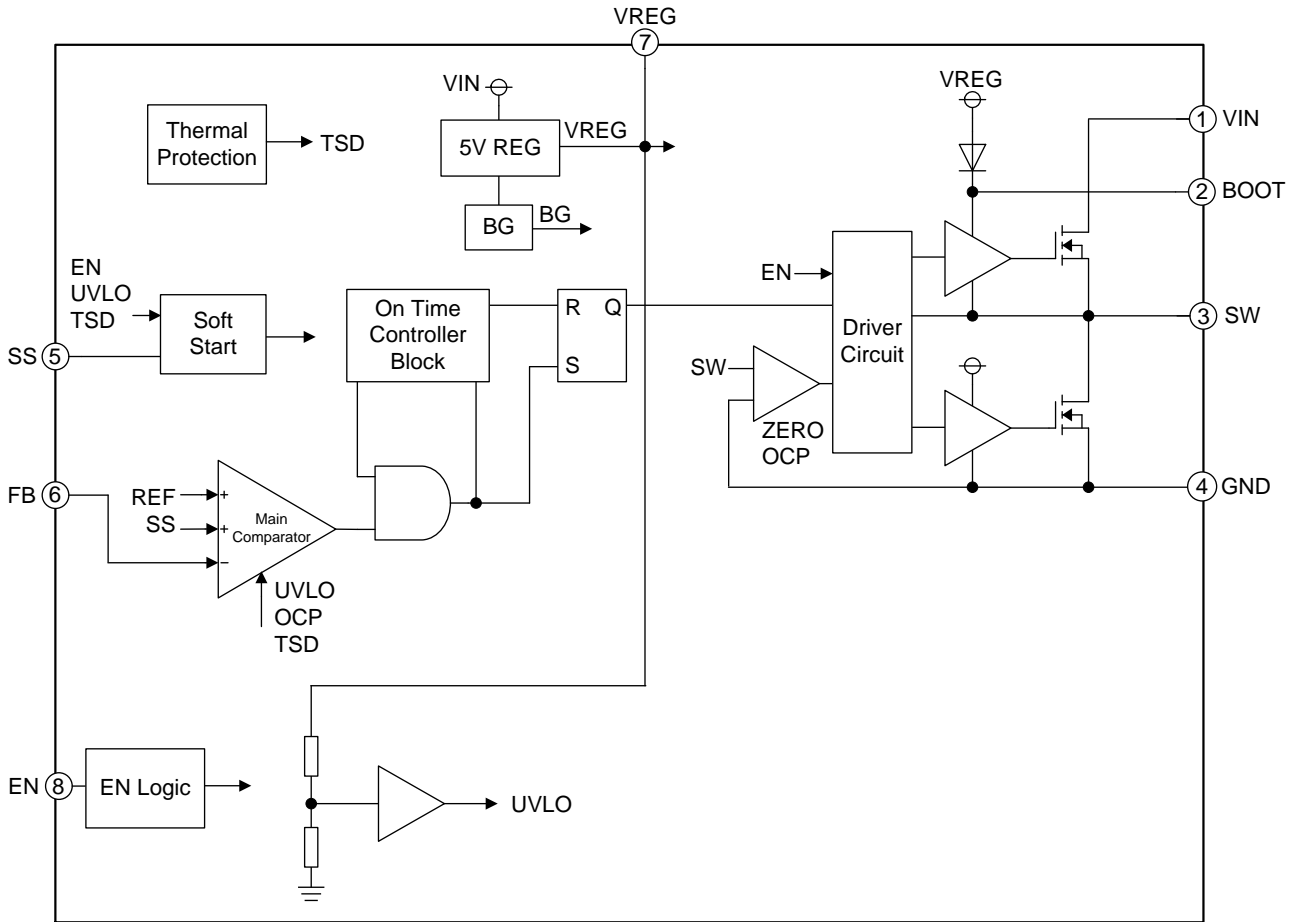

Figure 3. Block Diagram

Description of Blocks

1. EN Logic
The IC will shut down when EN falls to 0.3V (Max) or lower. When EN reaches 2.2V (Min), the internal circuit is activated and the IC starts up.
2. 5V REG
The 5V REG block generates the internal power supply 5.25V (Typ).
3. BG
The BG block generates the internal reference voltage (V_{REF}).
4. Main Comparator
When FB terminal voltage becomes lower than V_{REF} , the Main Comparator block outputs High and reports to the ON Time Controller Block that the output voltage has dropped below the control voltage.
5. ON Time Controller Block
This block generates ON Time. The desired ON Time is generated when Main Comparator output becomes High. ON Time is adjusted to restrict frequency change even with Input / Output voltage change.
6. Soft Start
The Soft Start circuit slows down the rise of output voltage during start-up and controls the current, which allows the prevention of output voltage overshoot and inrush current.
7. Driver Circuit
This block is a DC/DC driver. A signal from ON Time Controller Block is applied to drive the MOSFETs.
8. UVLO
UVLO is a protection circuit that prevents low voltage malfunction. It prevents malfunction of the internal circuit from sudden rise and fall of power supply voltage. It monitors the the internal power supply voltage (V_{REG}). When V_{REG} is higher than 3.8V (Typ), UVLO is released and the soft-start circuit will be started. This threshold voltage has a hysteresis of 300mV (Typ). When V_{REG} is less than 3.5V (Typ), the MOSFETs will turn OFF and the output voltage will shut down.
9. TSD
The TSD block is for thermal protection. The thermal protection circuit shuts down the device when the internal temperature of IC rises to 175°C (Typ) or higher. Thermal protection circuit resets when the temperature falls. The circuit has a hysteresis of 25°C (Typ).
10. OCP/ZERO
The OCP function is effective by controlling current which flows in Low-Side MOSFET by 1 cycle each of switching period. With inductor current exceeding the current restriction value I_{OCP} during Low-Side MOSFET is ON, the High-Side MOSFET cannot turn ON even with FB voltage is lower than V_{REF} voltage and Low-Side MOSFET keeps ON until it becomes below I_{OCP} . High-Side MOSFET will turn ON after it goes below I_{OCP} . When inductor current becomes below 0A (Typ) during Low-Side MOSFET is ON, the Low-Side MOSFET will turn OFF.

Absolute Maximum Ratings (Ta = 25°C)

Parameter	Symbol	Rating	Unit
Input Voltage	V _{IN}	-0.3 to +20	V
Voltage from GND to BOOT	V _{BOOT}	-0.3 to +27	V
Voltage from SW to BOOT	V _{BOOT} - V _{SW}	-0.3 to +7	V
FB Terminal Voltage	V _{FB}	-0.3 to V _{REG}	V
SW Terminal Voltage	V _{SW}	-0.5 to V _{IN} + 0.3	V
VREG Terminal Voltage	V _{REG}	-0.3 to +7	V
SS Terminal Voltage	V _{SS}	-0.3 to +7	V
EN Terminal Voltage	V _{EN}	-0.3 to V _{IN}	V
Maximum Junction Temperature	T _{jmax}	150	°C
Storage Temperature Range	T _{stg}	-55 to +150	°C

Caution 1: Operating the IC over the absolute maximum ratings may damage the IC. The damage can either be a short circuit between pins or an open circuit between pins and the internal circuitry. Therefore, it is important to consider circuit protection measures, such as adding a fuse, in case the IC is operated over the absolute maximum ratings.

Caution 2: Should by any chance the maximum junction temperature rating be exceeded the rise in temperature of the chip may result in deterioration of the properties of the chip. In case of exceeding this absolute maximum rating, increase the board size and copper area to prevent exceeding the maximum junction temperature rating.

Thermal Resistance (Note 1)

Parameter	Symbol	Thermal Resistance (Typ)		Unit
		1s ^(Note 3)	2s2p ^(Note 4)	
UMMP008Z2020				
Junction to Ambient	θ _{JA}	-	58.3	°C/W
Junction to Top Characterization Parameter ^(Note 2)	Ψ _{JT}	-	11	°C/W

(Note 1) Based on JESD51-2A (Still-Air)

(Note 2) The thermal characterization parameter to report the difference between junction temperature and the temperature at the top center of the outside surface of the component package.

(Note 3) Using a PCB board based on JESD51-3.

Layer Number of Measurement Board	Material	Board Size
Single	FR-4	114.3mm x 76.2mm x 1.57mmt

Top	
Copper Pattern	Thickness
Footprints and Traces	70µm

(Note 4) Using a PCB board based on JESD51-5, 7

Layer Number of Measurement Board	Material	Board Size	Thermal Via ^(Note 5)	
			Pitch	Diameter
4 Layers	FR-4	114.3mm x 76.2mm x 1.6mmt	-	Φ0.30mm

Top		2 Internal Layers		Bottom	
Copper Pattern	Thickness	Copper Pattern	Thickness	Copper Pattern	Thickness
Footprints and Traces	70µm	74.2mm x 74.2mm	35µm	74.2mm x 74.2mm	70µm

(Note 5) This thermal via connects with the copper pattern of all layers.

Recommended Operating Conditions

Parameter	Symbol	Min	Typ	Max	Unit
Input Voltage	V _{IN}	4.5	12	18	V
Operating Temperature Range	T _{opr}	-40	-	+85 (Note 1)	°C
Output Current	I _{OUT}	0	-	3	A
Output Voltage Range	V _{RANGE}	0.765 (Note 2)	-	7 (Note 3)	V

(Note 1) T_J must be lower than 150°C under actual operating environment.

(Note 2) Please use under the condition of V_{OUT} ≥ V_{IN} × 0.07 [V].

(Note 3) Please use under the condition of V_{OUT} ≤ V_{IN} × 0.65 [V].

(Refer to the page 28 for how to calculate the output voltage setting.)

Electrical Characteristics (T_a = 25°C, V_{IN} = 12V, V_{EN} = 3V unless otherwise specified)

Parameter	Symbol	Min	Typ	Max	Unit	Conditions
Standby Circuit Current	I _{STB}	-	2	15	μA	V _{EN} =GND
Operating Circuit Current	I _{VIN}	-	0.7	2	mA	I _{OUT} =0mA Non switching
EN Low Voltage	V _{ENL}	GND	-	0.3	V	
EN High Voltage	V _{ENH}	2.2	-	V _{IN}	V	
EN Input Current	I _{EN}	-	1.5	5	μA	V _{EN} =3V
VREG Standby Voltage	V _{REG_STB}	-	-	0.1	V	V _{EN} =GND
VREG Output Voltage	V _{REG}	5	5.25	5.5	V	
VREG Output Current	I _{REG}	-	10	-	mA	
UVLO Threshold Voltage	V _{REG_UVLO}	3.4	3.8	4.2	V	V _{REG} : Sweep up
UVLO Hysteresis Voltage	dV _{REG_UVLO}	200	300	400	mV	V _{REG} : Sweep down
Reference Voltage	V _{REF}	0.753	0.765	0.777	V	V _{IN} =12V, V _{OUT} =1.8V PWM Mode Operation
FB Input Current	I _{FB}	-	-	1	μA	V _{FB} =1V
SS Charge Current	I _{SSC}	1.4	2.0	2.6	μA	
SS Discharge Current	I _{SSD}	0.1	0.2	-	mA	V _{REG} =5.25V, V _{SS} =0.5V
ON Time	t _{ON}	-	215	-	ns	V _{IN} =12V, V _{OUT} =1.8V PWM Mode Operation
Minimum OFF Time	t _{OFFMIN}	100	200	-	ns	
High Side FET ON-Resistance	R _{ONH}	-	80	160	mΩ	
Low Side FET ON-Resistance	R _{ONL}	-	50	100	mΩ	
Over Current Protection Current Limit	I _{OC}	-	5 (Note 4)	-	A	

(Note 4) No tested on outgoing inspection.

Typical Performance Curves

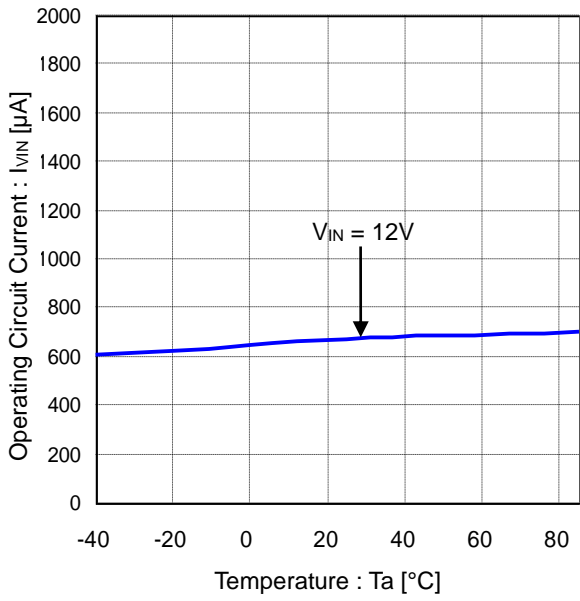

Figure 4. Operating Circuit Current vs Temperature

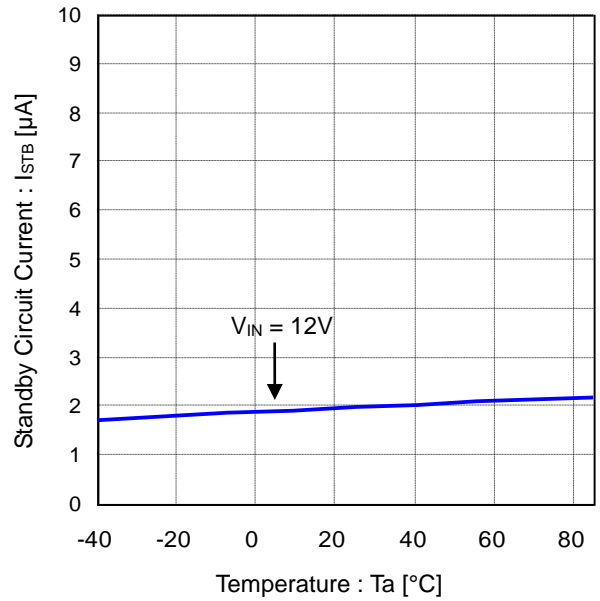

Figure 5. Standby Circuit Current vs Temperature

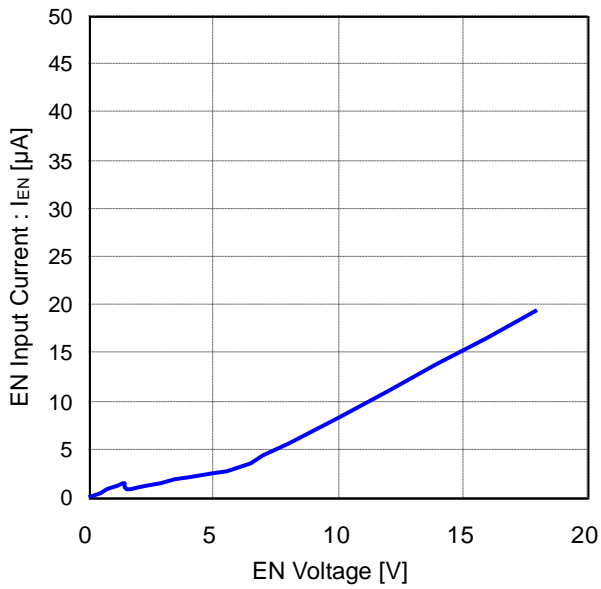

Figure 6. EN Input Current vs EN Voltage

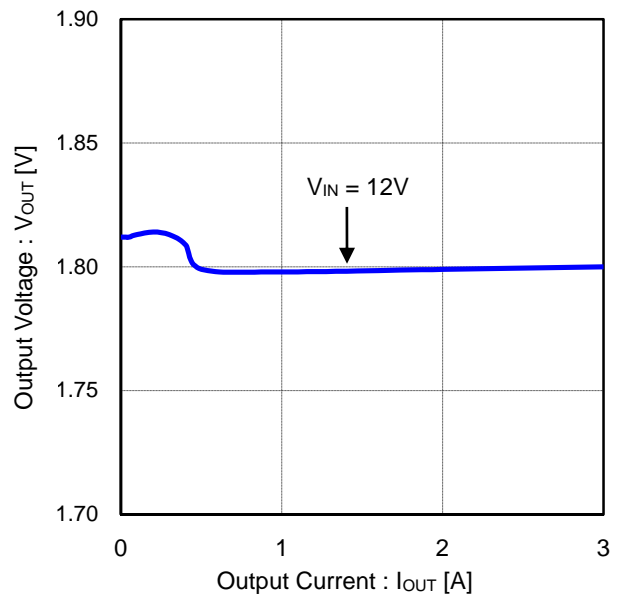

Figure 7. Output Voltage vs Output Current

Typical Performance Curves - continued

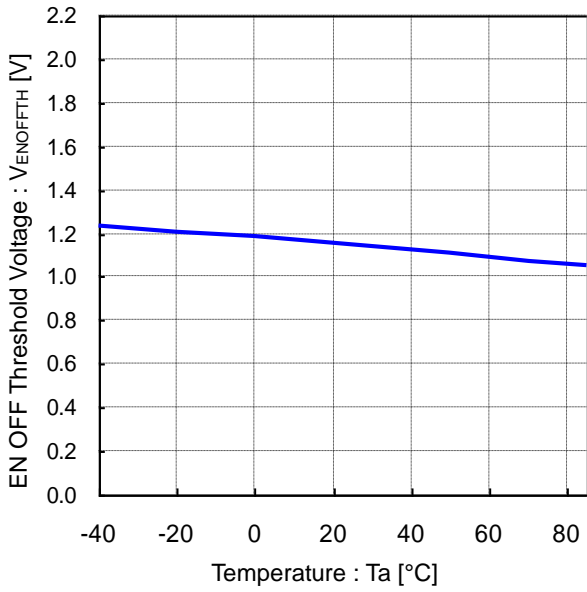

Figure 8. EN OFF Threshold Voltage vs Temperature

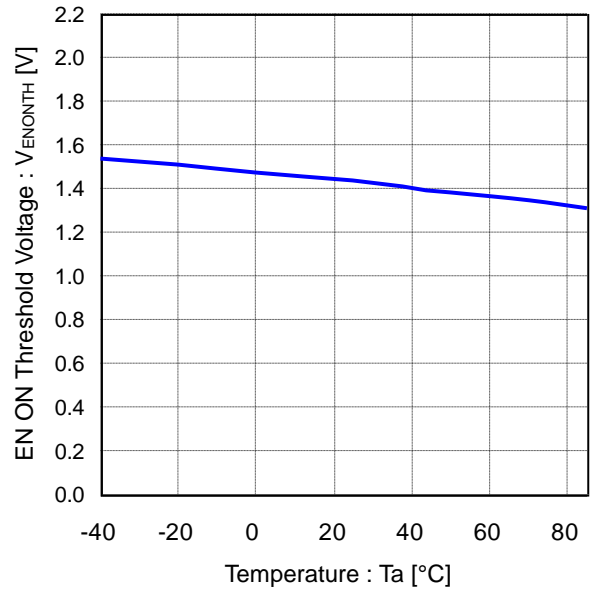

Figure 9. EN ON Threshold Voltage vs Temperature

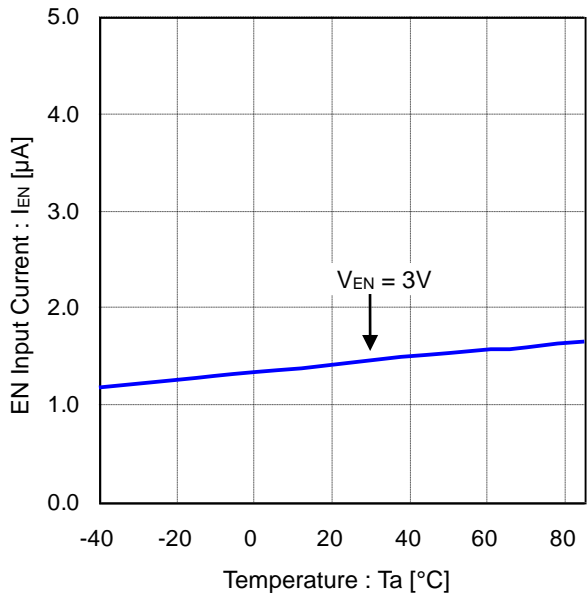

Figure 10. EN Input Current vs Temperature

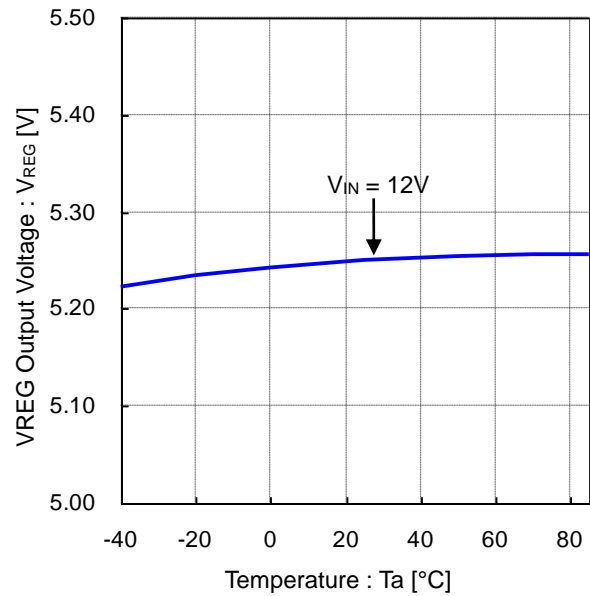

Figure 11. VREG Output Voltage vs Temperature

Typical Performance Curves - continued

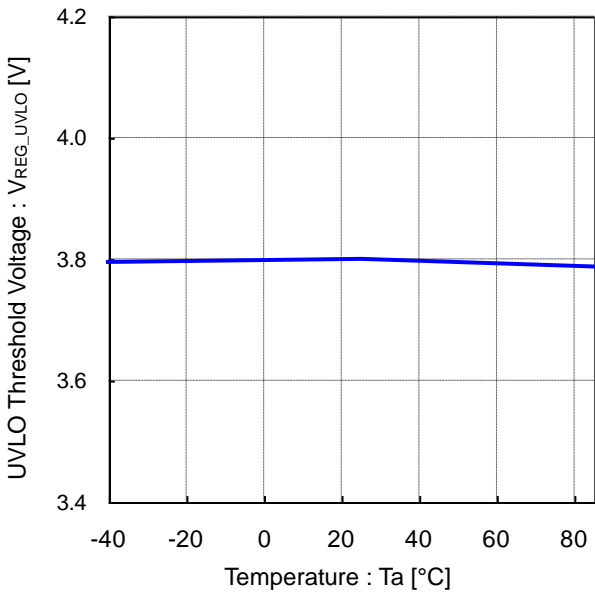

Figure 12. UVLO Threshold Voltage vs Temperature

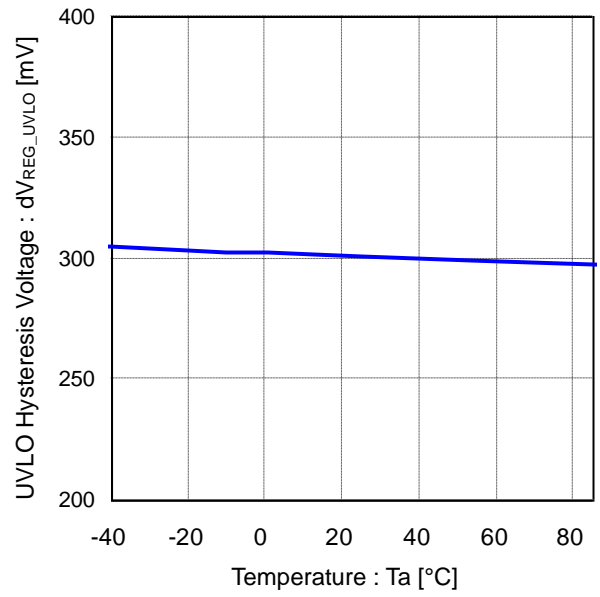

Figure 13. UVLO Hysteresis Voltage vs Temperature

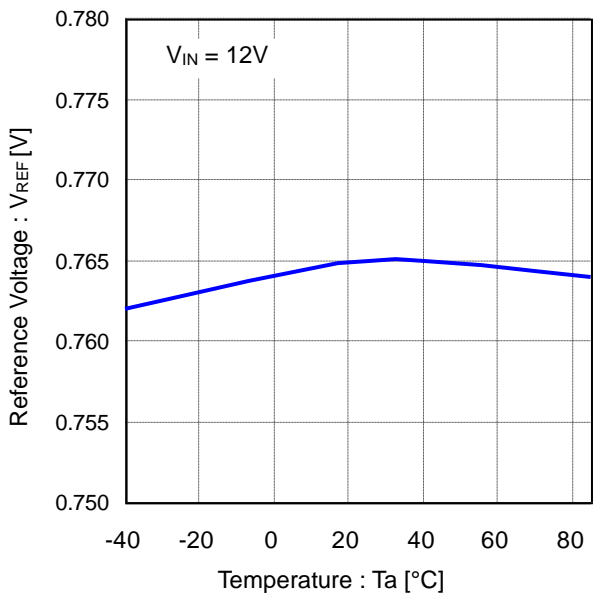

Figure 14. Reference Voltage vs Temperature

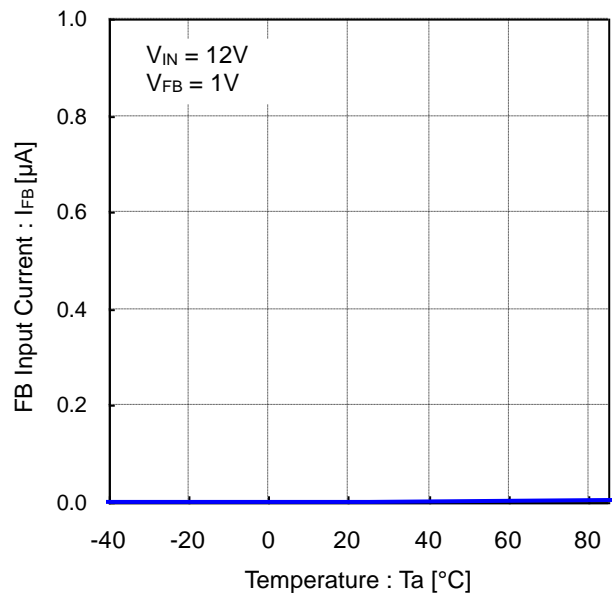

Figure 15. FB Input Current vs Temperature

Typical Performance Curves - continued

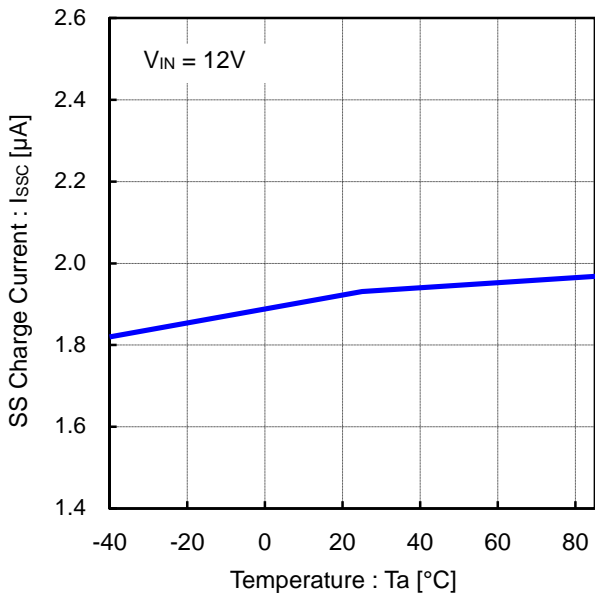

Figure 16. SS Charge Current vs Temperature

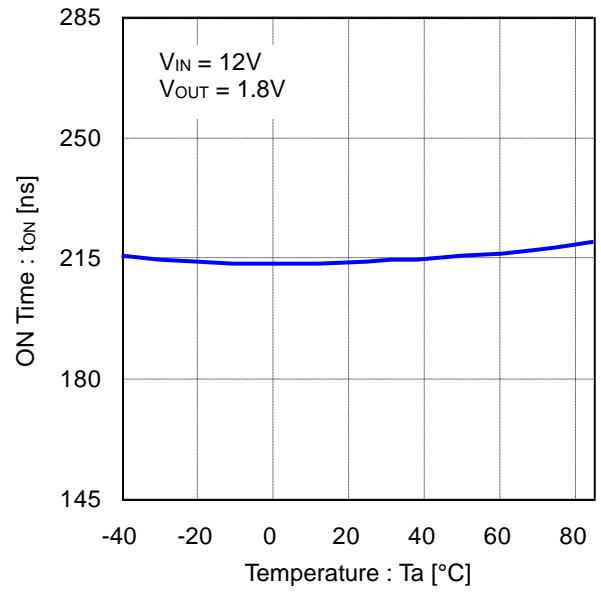

Figure 17. ON Time vs Temperature

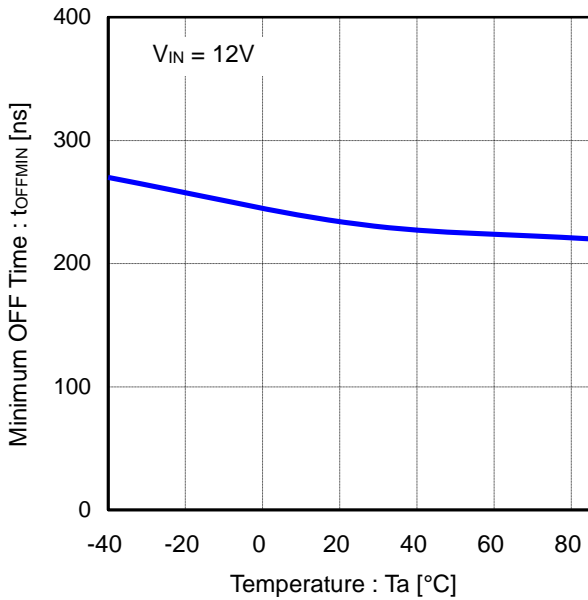

Figure 18. Minimum OFF Time vs Temperature

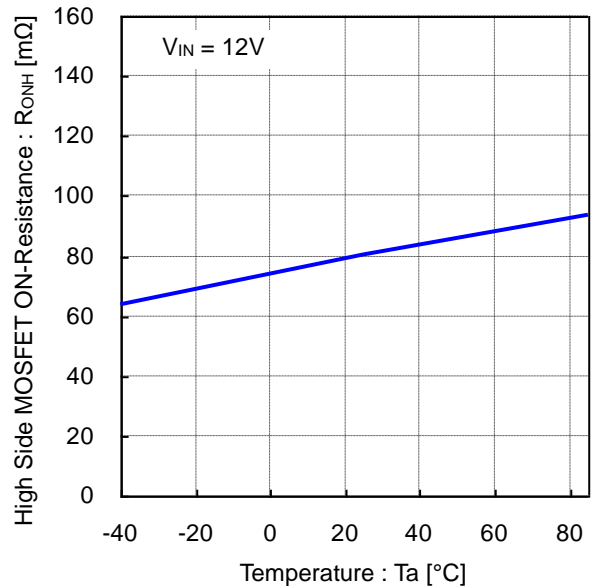

Figure 19. High Side MOSFET ON-Resistance vs Temperature

Typical Performance Curves - continued

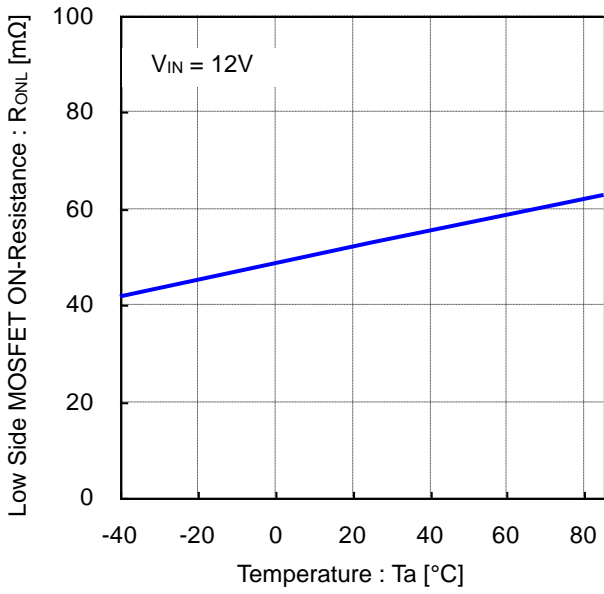

Figure 20. Low Side MOSFET ON-Resistance vs Temperature

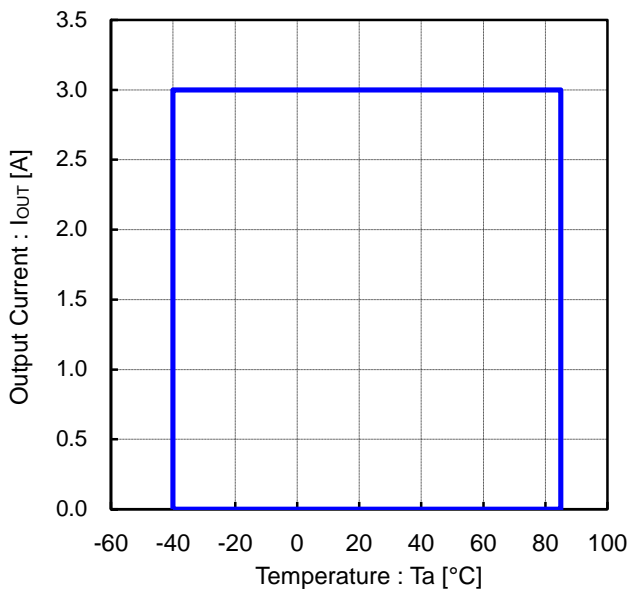

Figure 21. Operational Range $V_{IN} = 12V$, $V_{OUT} = 1V$ ($T_j < 150^\circ C$)
(Measured on FR-4 board 67.5 mm x 67.5 mm,
Copper Thickness : Top and Bottom 70 μm , 2 Internal Layers 35 μm)

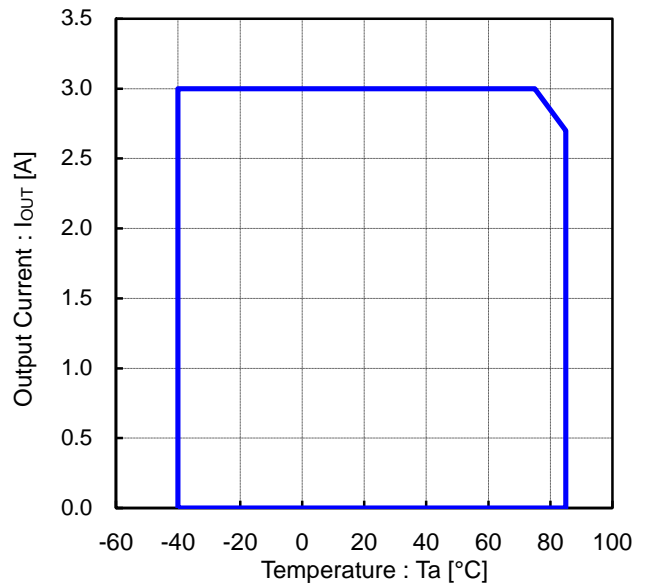

Figure 22. Operational Range $V_{IN} = 12V$, $V_{OUT} = 5V$ ($T_j < 150^\circ C$)
(Measured on FR-4 board 67.5 mm x 67.5 mm,
Copper Thickness : Top and Bottom 70 μm , 2 Internal Layers 35 μm)

Typical Performance Curves - continued

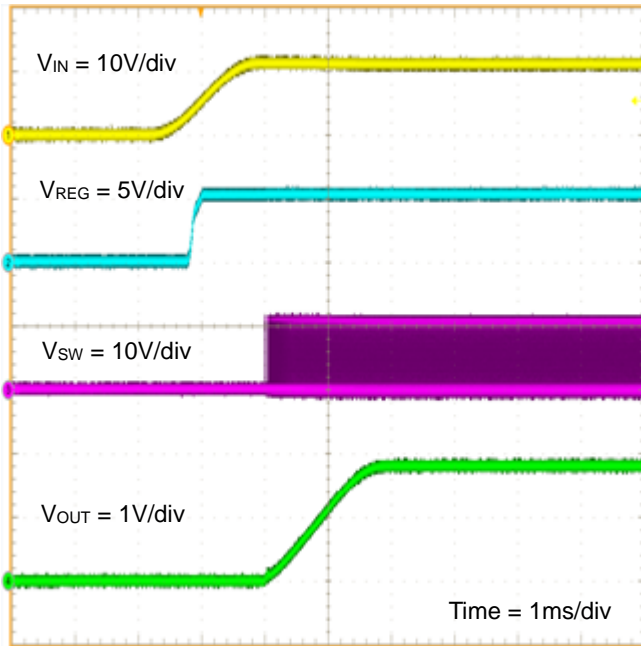

Figure 23. Start-up Waveform ($V_{IN} = V_{EN}$)
($V_{IN} = 12V$, $V_{OUT} = 1.8V$, $I_{OUT} = 3A$, $C_{SS} = 3300pF$)

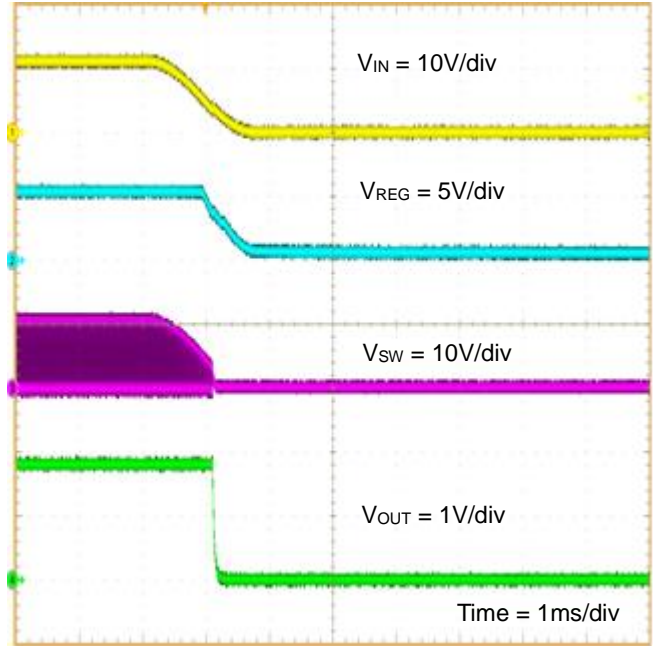

Figure 24. Shutdown Waveform ($V_{IN} = V_{EN}$)
($V_{IN} = 12V$, $V_{OUT} = 1.8V$, $I_{OUT} = 3A$, $C_{SS} = 3300pF$)

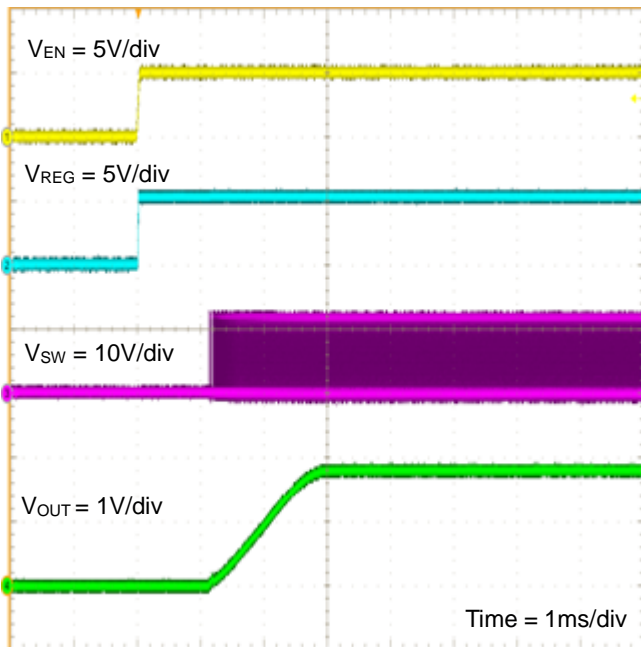

Figure 25. Start-up Waveform ($V_{EN} = 0V$ to $5V$)
($V_{IN} = 12V$, $V_{OUT} = 1.8V$, $I_{OUT} = 3A$, $C_{SS} = 3300pF$)

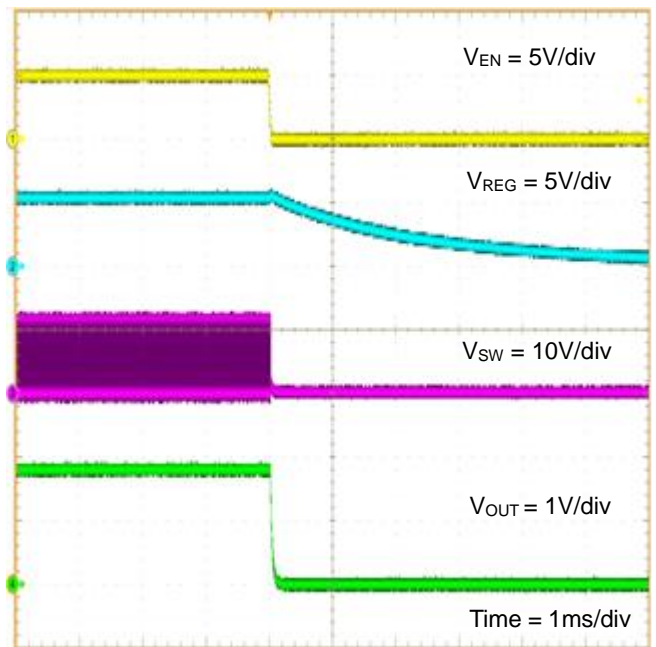

Figure 26. Shutdown Waveform ($V_{EN} = 5V$ to $0V$)
($V_{IN} = 12V$, $V_{OUT} = 1.8V$, $I_{OUT} = 3A$, $C_{SS} = 3300pF$)

Typical Performance Curves - continued

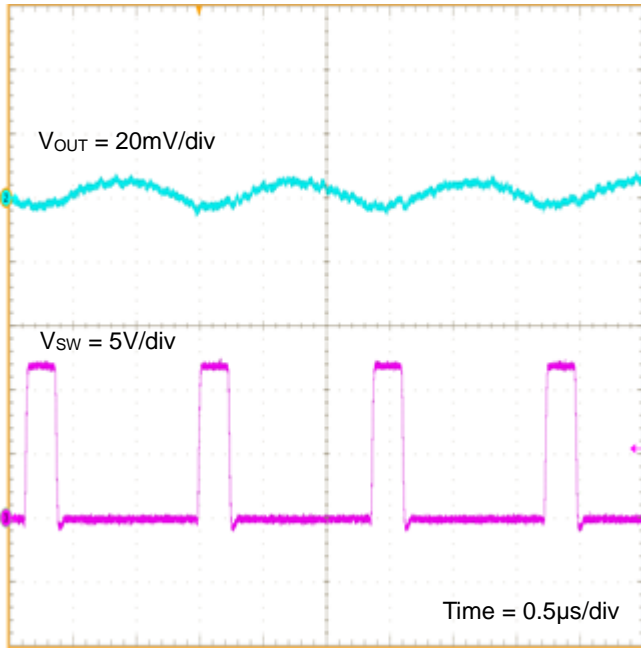

Figure 27. V_{OUT} Ripple
($V_{IN} = 12V$, $V_{OUT} = 1.8V$, $I_{OUT} = 3A$, $L = 2.2\mu H$, $C_{OUT} = 22\mu F \times 2$)

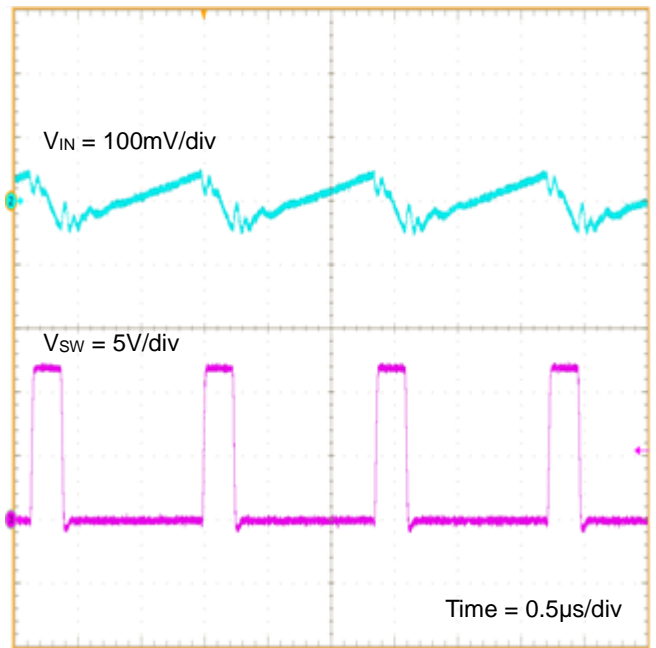

Figure 28. V_{IN} Ripple
($V_{IN} = 12V$, $V_{OUT} = 1.8V$, $I_{OUT} = 3A$, $L = 2.2\mu H$, $C_{OUT} = 22\mu F \times 2$)

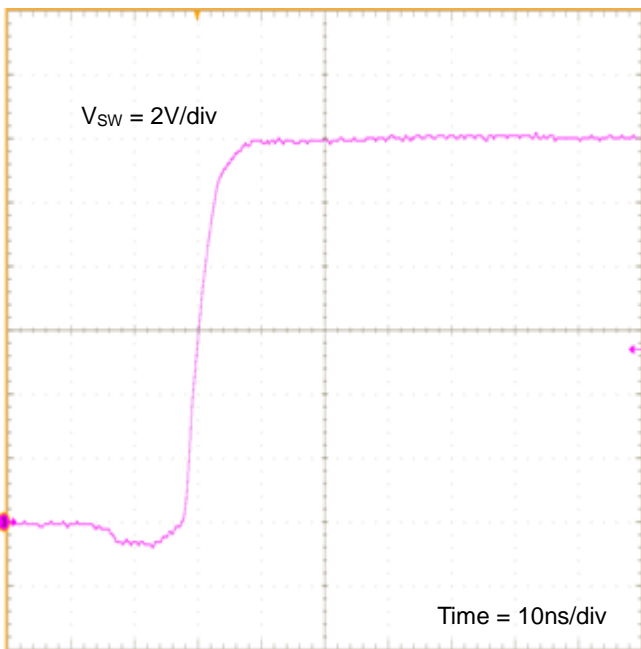

Figure 29. SW Turn ON
($V_{IN} = 12V$, $V_{OUT} = 1.8V$, $I_{OUT} = 3A$, $L = 2.2\mu H$, $C_{OUT} = 22\mu F \times 2$)

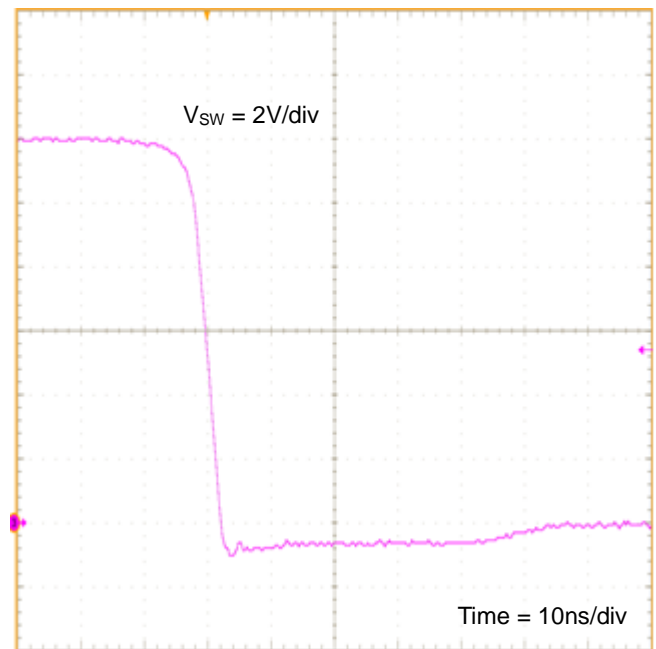

Figure 30. SW Turn OFF
($V_{IN} = 12V$, $V_{OUT} = 1.8V$, $I_{OUT} = 3A$, $L = 2.2\mu H$, $C_{OUT} = 22\mu F \times 2$)

Typical Performance Curves - continued

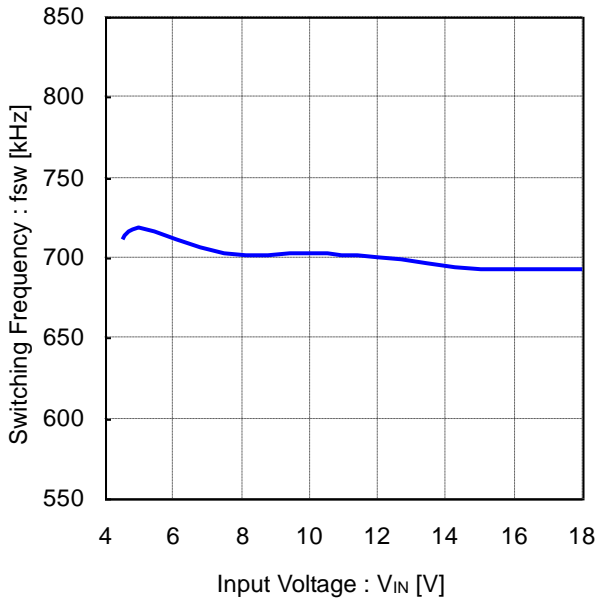

Figure 31. Switching Frequency vs Input Voltage ($V_{OUT} = 1.8V$, $I_{OUT} = 3A$, $L = 2.2\mu H$, $C_{OUT} = 22\mu F \times 2$)

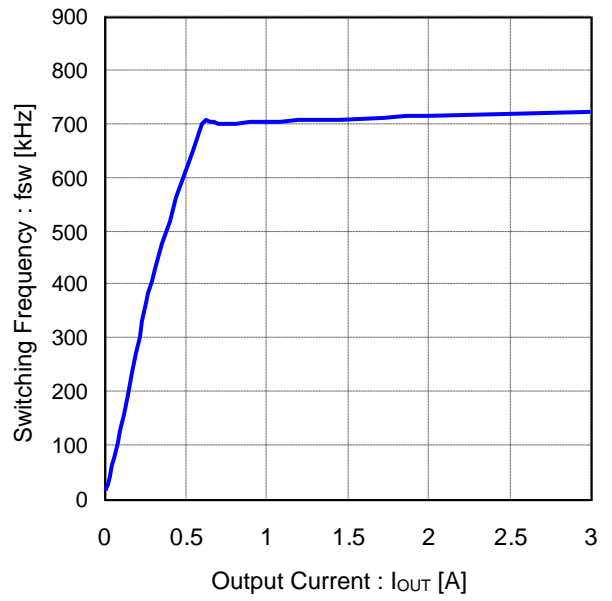

Figure 32. Switching Frequency vs Output Current ($V_{IN} = 12V$, $V_{OUT} = 1.8V$, $L = 2.2\mu H$, $C_{OUT} = 22\mu F \times 2$)

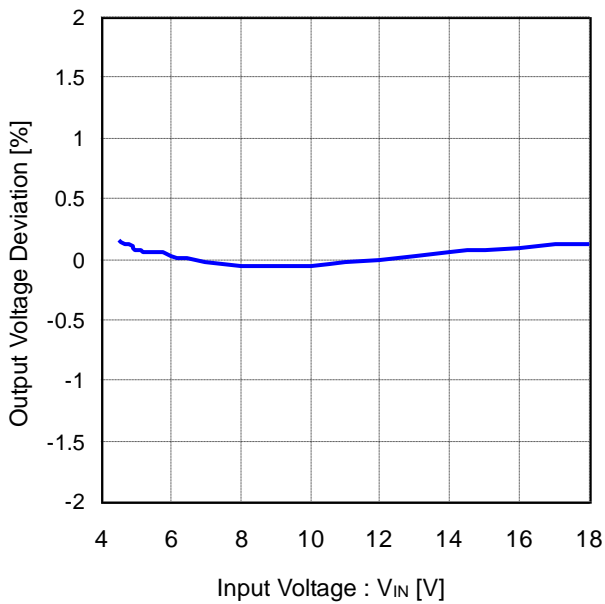

Figure 33. V_{OUT} Line Regulation ($V_{OUT} = 1.8V$, $I_{OUT} = 1A$)

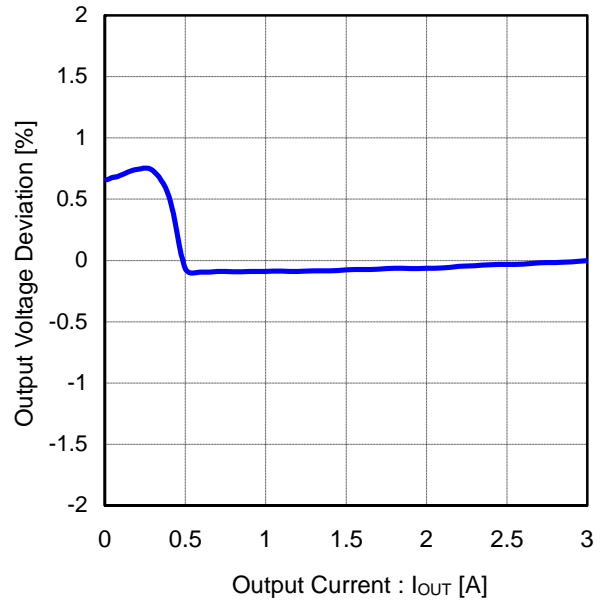

Figure 34. V_{OUT} Load Regulation ($V_{IN} = 12V$, $V_{OUT} = 1.8V$)

Function Explanations

1. Basic Operation

(1) Constant ON Time Control

BD9D322QWZ is a single synchronous buck DC/DC converter employing a constant ON-time control system. It controls the ON-time by using the duty ratio of V_{OUT}/V_{IN} inside IC so that a switching frequency becomes 700kHz. Therefore it runs with the frequency of 700 kHz under the constant ON-time decided with V_{OUT} / V_{IN} .

(2) SLLM™ Control

BD9D322QWZ utilizes switching operation in PWM (Pulse Width Modulation) mode for heavier load, while it utilizes SLLM (Simple Light Load Mode) control for lighter load to improve efficiency.

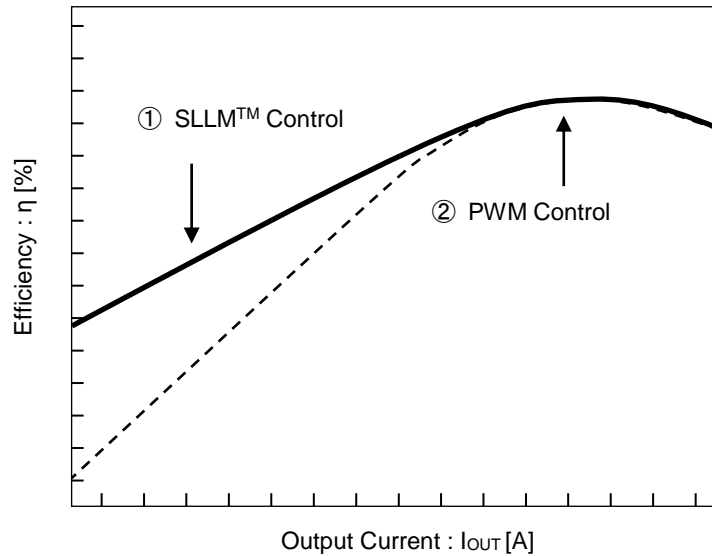

Figure 35. Efficiency vs Output Current (SLLM™ Control and PWM Control)

①SLLM™ Control

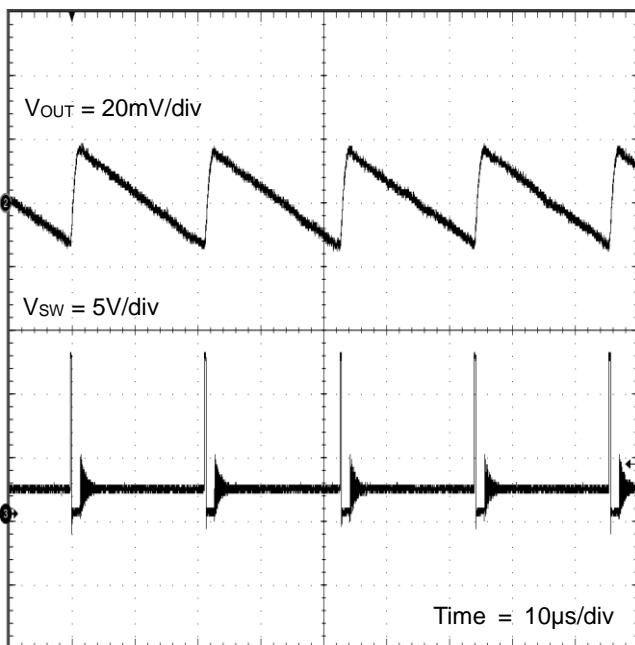

Figure 36. SW Waveform (①SLLM™ Control)
($V_{IN} = 12V, V_{OUT} = 1.8V, I_{OUT} = 30mA$)

②PWM Control

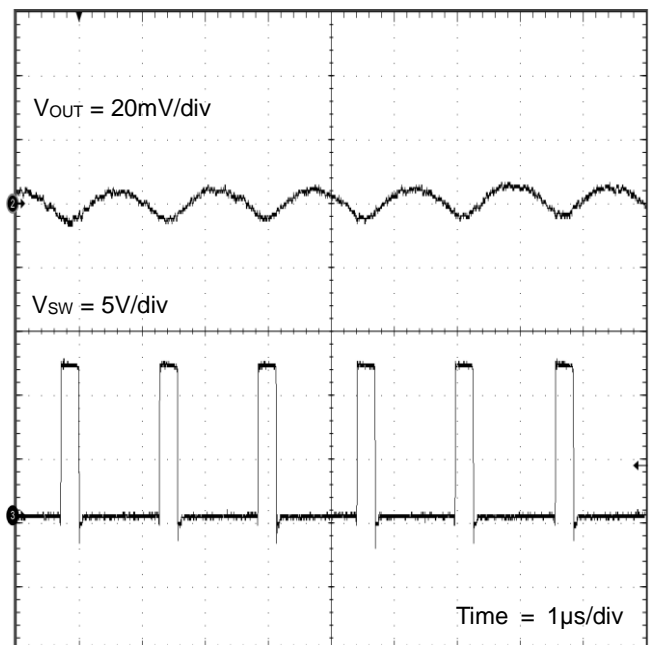

Figure 37. SW Waveform (②PWM Control)
($V_{IN} = 12V, V_{OUT} = 1.8V, I_{OUT} = 3A$)

(3) Enable Control

The IC shutdown can be controlled by the voltage applied to the EN terminal. When V_{EN} reaches 2.2V (Min), the internal circuit is activated and the IC starts up. To enable shutdown control with the EN terminal, the shutdown slew rate of EN must be set to less than -1.0V/ms.

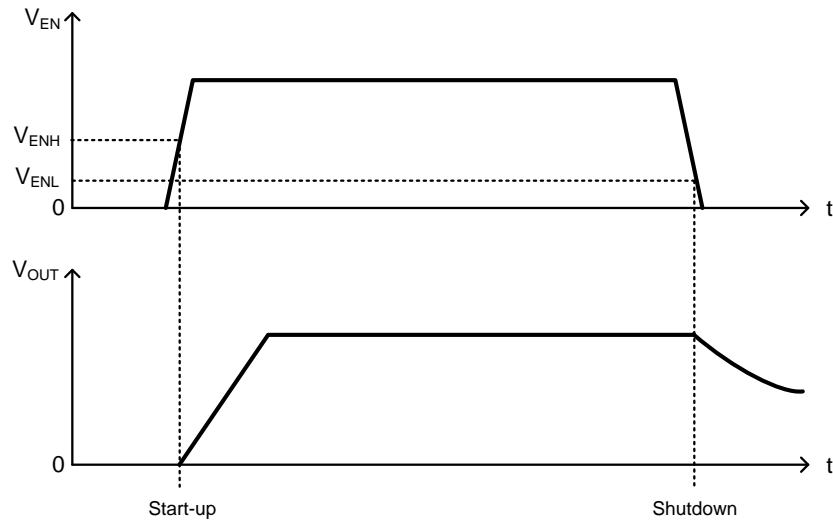

Figure 38. Start-up and Shutdown with Enable

(4) Soft Start Function

When EN terminal is switched High, Soft Start operates and the output voltage gradually rises. With the Soft Start Function, overshoot of output voltage and rush current can be prevented. Rising time can be set by connecting capacitor to SS terminal. For setting the rising time, please refer to page 29.

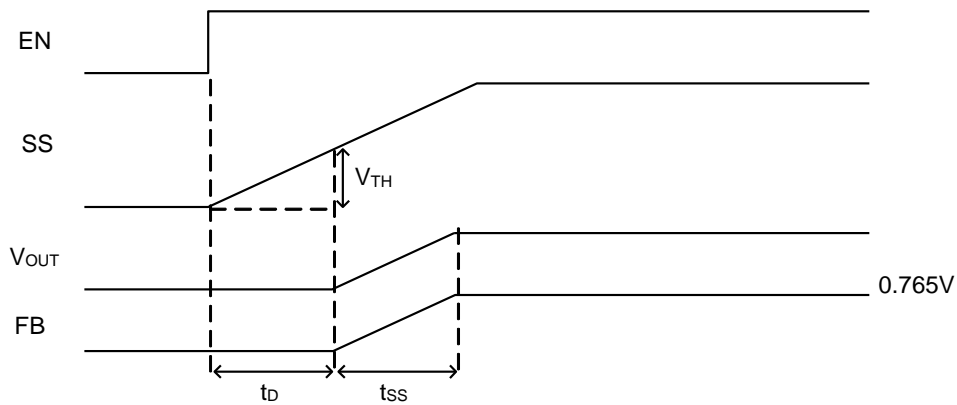

Figure 39. Soft Start Timing Chart

2. Protective Functions

The protective circuits are intended for prevention of damage caused by unexpected accidents. Do not use them for continuous protective operation.

(1) Over Current Protection (OCP)

Over current protection function is effective by controlling current which flows in Low-Side MOSFET by 1 cycle each of switching period. With inductor current exceeding the current restriction value I_{OCP} during LG is ON, the HG pulse cannot turn ON even with FB voltage is lower than V_{REF} voltage and Low-Side MOSFET keeps ON until it becomes below I_{OCP} . High-Side MOSFET will turn ON after it goes below I_{OCP} . As a result, both frequency and duty fluctuates and output voltage may decrease.

In a case where output is decreased because of OCP, output may rise after OCP is released due to the action at high speed load response. This is non-latch protection and after over-current situation is released the output voltage will recover.

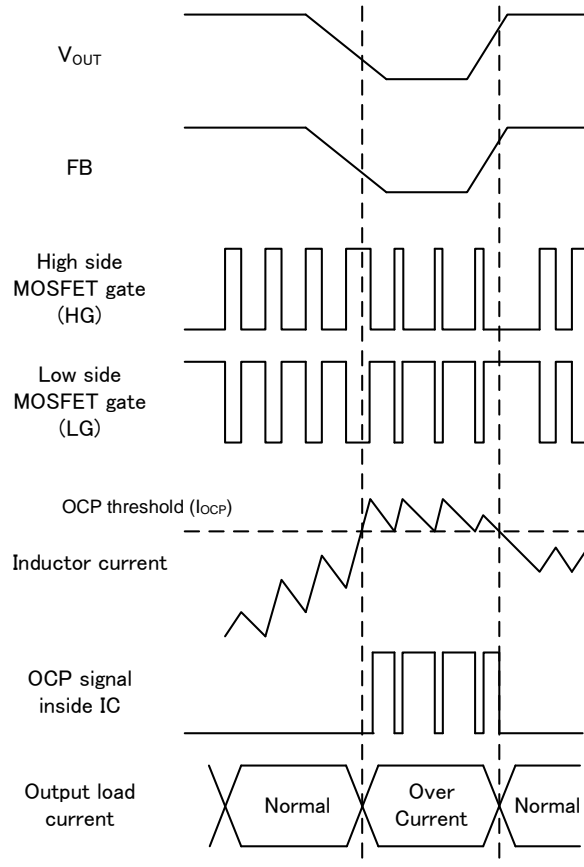

Figure 40. Over Current Protection Timing Chart

(2) Under Voltage Lockout Protection (UVLO)

The Under Voltage Lockout Protection circuit monitors the VREG terminal voltage. The operation enters standby when the VREG terminal voltage is 3.5V (Typ) or lower. The operation starts when the VREG terminal voltage is 3.8V (Typ) or higher.

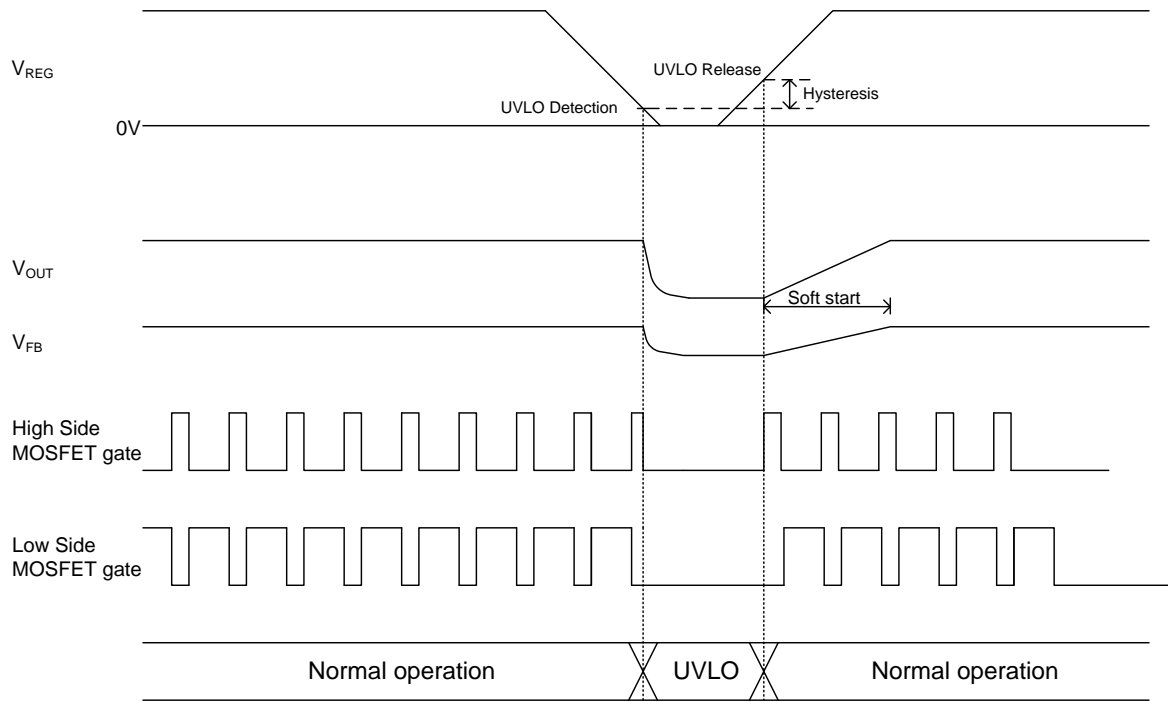

Figure 41. UVLO Timing Chart

(Note) Load at Start-up

Ensure that the respective output has light load at startup of this IC. Also, restrain the power supply line noise at start-up and voltage drop generated by operating current within the hysteresis width of UVLO. Noise exceeding the hysteresis noise width may cause the IC to malfunction.

(3) Thermal Shutdown Function

When the chip temperature exceeds T_j = 175°C (Typ), the DC/DC converter is stopped. The thermal shutdown circuit is intended for shutting down the IC from thermal runaway in an abnormal state with the temperature exceeding T_{jmax} = 150°C. Do not use this function for application protection design. This is non-latch protection.

Application Example (V_{OUT} = 5.0V)

Parameter	Symbol	Specification Example
Input Voltage	V _{IN}	12V
Output Voltage	V _{OUT}	5.0V
Switching Frequency	f _{osc}	700kHz(Typ)
Maximum Output Current	I _{OUTMAX}	3A
Operating Temperature Range	Topr	-40°C to +75°C

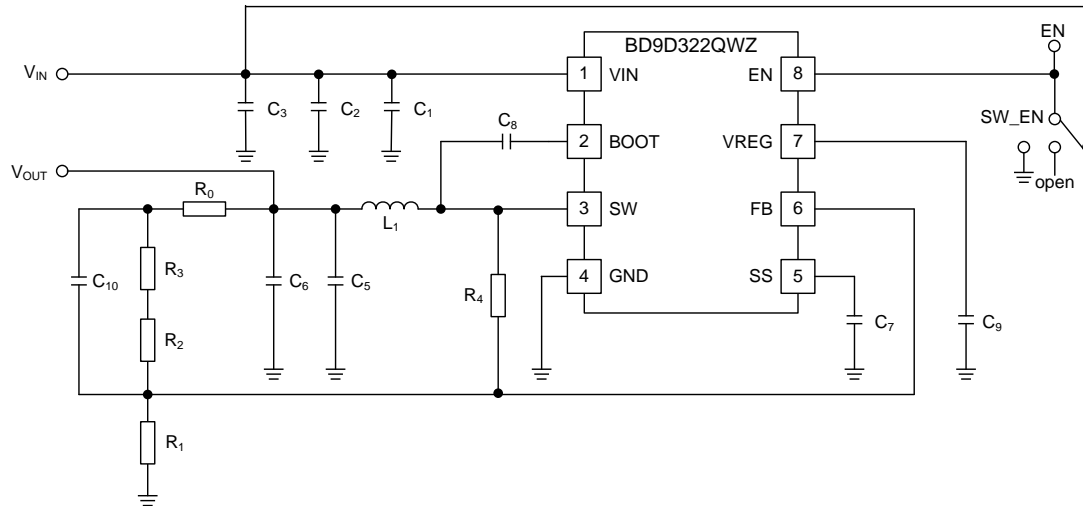

Figure 42. Application Circuit

Table 1. Recommended Component Values

Part No	Value	Company	Part Name
L ₁	3.3μH	Murata	FDSD0518-H-3R3M
C ₁ (Note 1)	0.1μF	Murata	GRM188R71H104KA93D
C ₂ (Note 2)	10μF	Murata	GRM32DB31E106KA75L
C ₃ (Note 2)	10μF	Murata	GRM32DB31E106KA75L
C ₅ (Note 3)	22μF	Murata	GRM32EB31E226ME15L
C ₆ (Note 3)	22μF	Murata	GRM32EB31E226ME15L
C ₇	3300pF	Murata	GRM155B11H332KA01
C ₈	0.1μF	Murata	GRM188R71H104KA93D
C ₉	1μF	Murata	GRM188B11A105KA61D
C ₁₀	22pF	Murata	GRM1552C1E220JA01
R ₀	0Ω	ROHM	MCR01MZPJ000
R ₁	22kΩ	ROHM	MCR01MZPF2202
R ₂	120kΩ	ROHM	MCR01MZPF1203
R ₃	1.8kΩ	ROHM	MCR01MZPF1801
R ₄	OPEN	-	-

- (Note 1) In order to reduce the influence of high frequency noise, arrange the 0.1μF ceramic capacitor as close as possible to the VIN pin and GND pin.
- (Note 2) For capacitance of input capacitor, take temperature characteristics, DC bias characteristics, etc. into consideration to set minimum value to no less than 4.7μF. When VIN is lower than 7V at normal state, add capacitor same as C₂ to C₃.
- (Note 3) In case capacitance value fluctuates due to temperature characteristics, DC bias characteristics, etc. of output capacitor, Loop Response may fluctuate. Please confirm on actual equipment. When selecting a capacitor, confirm the characteristics of the capacitor in its datasheet, Please use capacitors such as ceramic type are recommended for output capacitor.

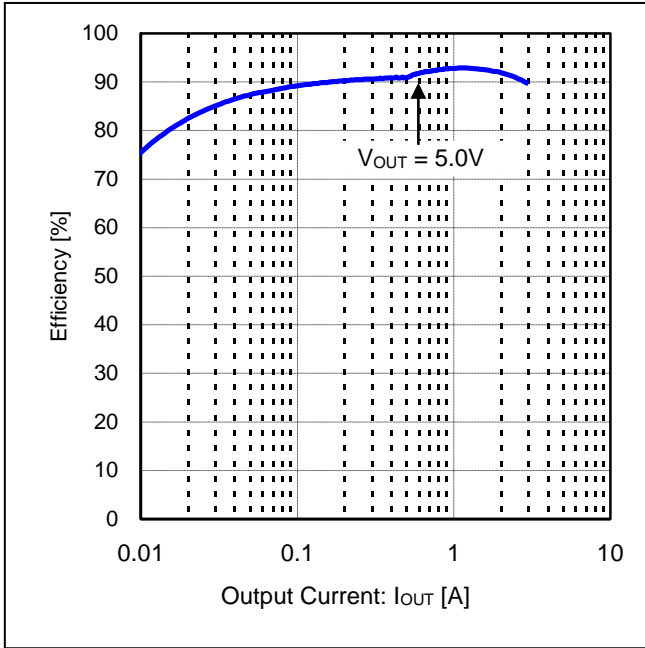

Figure 43. Efficiency vs Output Current
($V_{IN} = 12V$, $V_{OUT} = 5.0V$)

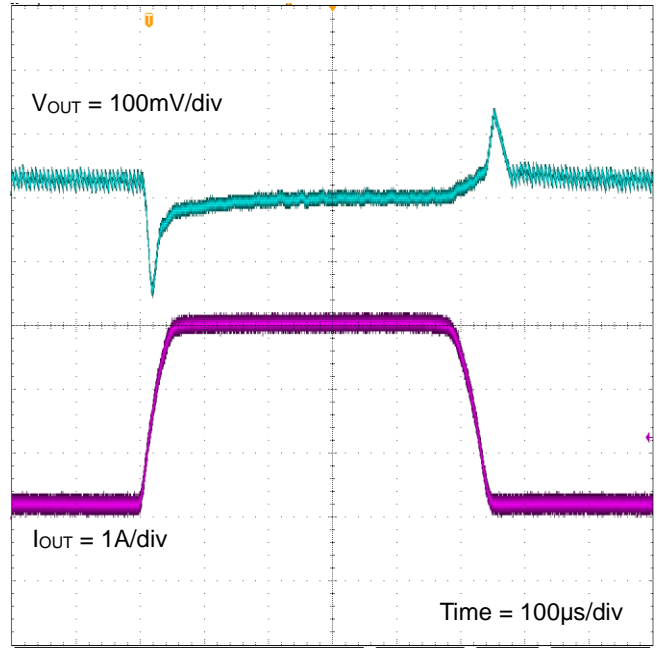

Figure 44. Load Transient Response $I_{OUT} = 0.1A - 3A$
($V_{IN} = 12V$, $V_{OUT} = 5.0V$)

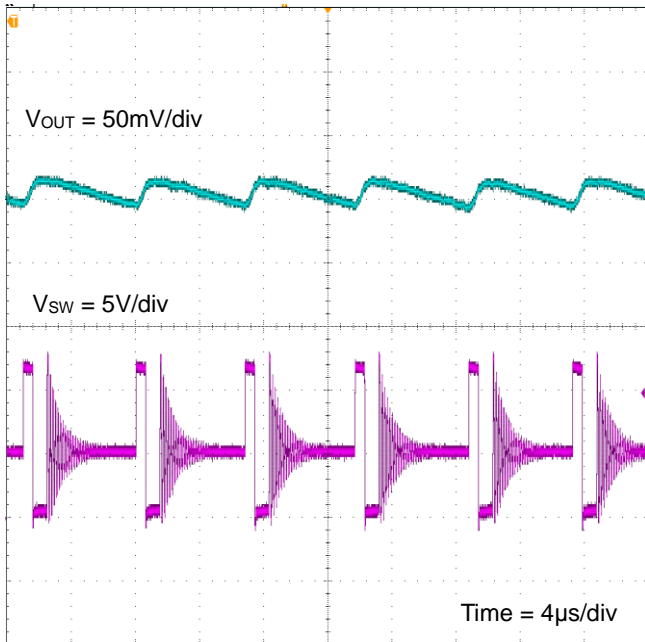

Figure 45. V_{OUT} Ripple $I_{OUT} = 0.1A$
($V_{IN} = 12V$, $V_{OUT} = 5.0V$)

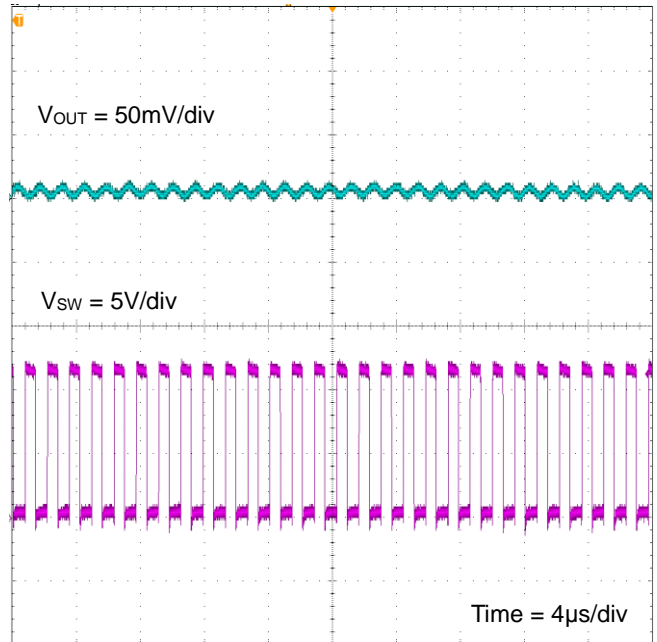

Figure 46. V_{OUT} Ripple $I_{OUT} = 3.0A$
($V_{IN} = 12V$, $V_{OUT} = 5.0V$)

Application Example (V_{OUT} = 3.3V)

Parameter	Symbol	Specification Example
Input Voltage	V _{IN}	12V
Output Voltage	V _{OUT}	3.3V
Switching Frequency	f _{osc}	700kHz(Typ)
Maximum Output Current	I _{OUTMAX}	3A
Operating Temperature Range	Topr	-40°C to +85°C

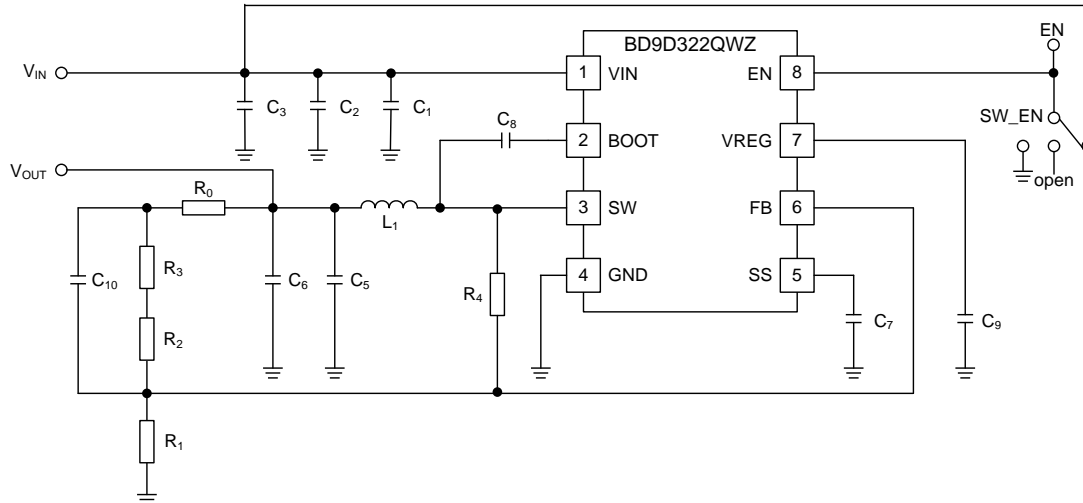

Figure 47. Application Circuit

Table 2. Recommended Component Values

Part No	Value	Company	Part Name
L ₁	2.2μH	Murata	FDSD0518-H-2R2M
C ₁ (Note 1)	0.1μF	Murata	GRM188R71H104KA93D
C ₂ (Note 2)	10μF	Murata	GRM32DB31E106KA75L
C ₃ (Note 2)	10μF	Murata	GRM32DB31E106KA75L
C ₅ (Note 3)	22μF	Murata	GRM31CB31A226ME19L
C ₆ (Note 3)	22μF	Murata	GRM31CB31A226ME19L
C ₇	3300pF	Murata	GRM155B11H332KA01
C ₈	0.1μF	Murata	GRM188R71H104KA93D
C ₉	1μF	Murata	GRM188B11A105KA61D
C ₁₀	27pF	Murata	GRM1552C1E270JA01
R ₀	0Ω	ROHM	MCR01MZPJ000
R ₁	22kΩ	ROHM	MCR01MZPF2202
R ₂	68kΩ	ROHM	MCR01MZPF6802
R ₃	5.1kΩ	ROHM	MCR01MZPF5101
R ₄	OPEN	-	-

- (Note 1) In order to reduce the influence of high frequency noise, arrange the 0.1μF ceramic capacitor as close as possible to the VIN pin and GND pin.
- (Note 2) For capacitance of input capacitor, take temperature characteristics, DC bias characteristics, etc. into consideration to set minimum value to no less than 4.7μF. When VIN is lower than 7V at normal state, add capacitor same as C₂ to C₃.
- (Note 3) In case capacitance value fluctuates due to temperature characteristics, DC bias characteristics, etc. of output capacitor, Loop Response may fluctuate. Please confirm on actual equipment. When selecting a capacitor, confirm the characteristics of the capacitor in its datasheet, Please use capacitors such as ceramic type are recommended for output capacitor.

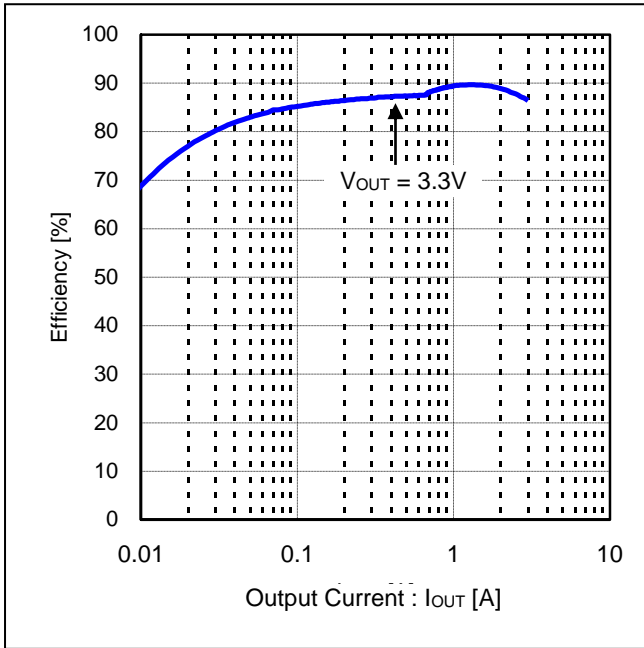

Figure 48. Efficiency vs Output Current
($V_{IN} = 12V$, $V_{OUT} = 3.3V$)

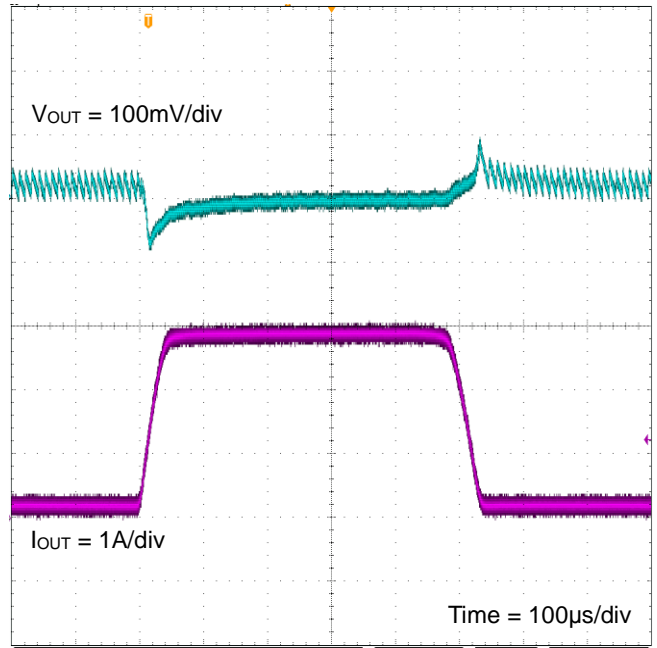

Figure 49. Load Transient Response $I_{OUT} = 0.1A - 3A$
($V_{IN} = 12V$, $V_{OUT} = 3.3V$)

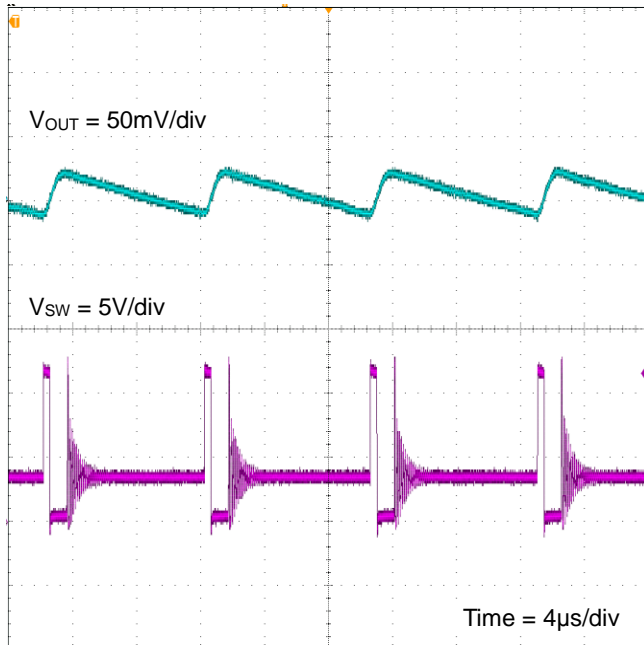

Figure 50. V_{OUT} Ripple $I_{OUT} = 0.1A$
($V_{IN} = 12V$, $V_{OUT} = 3.3V$)

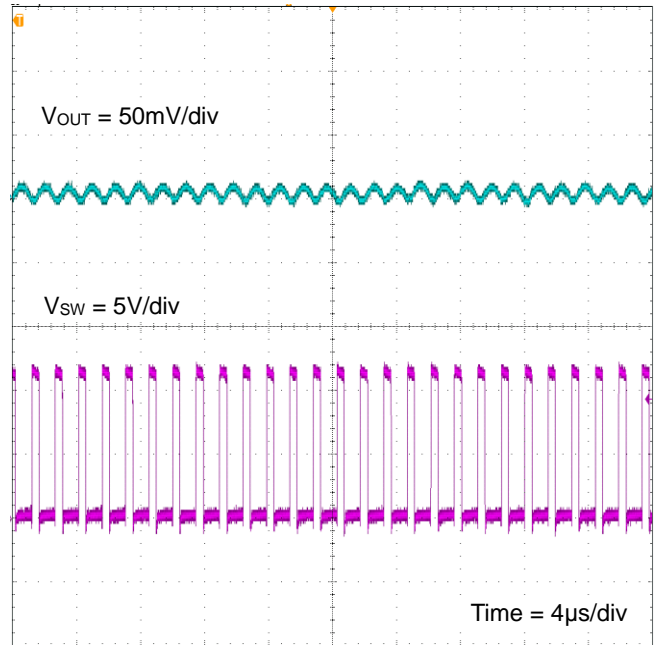

Figure 51. V_{OUT} Ripple $I_{OUT} = 3.0A$
($V_{IN} = 12V$, $V_{OUT} = 3.3V$)

Application Example (V_{OUT} = 1.8V)

Parameter	Symbol	Specification Example
Input Voltage	V _{IN}	12V
Output Voltage	V _{OUT}	1.8V
Switching Frequency	f _{osc}	700kHz(Typ)
Maximum Output Current	I _{OUTMAX}	3A
Operating Temperature Range	Topr	-40°C to +85°C

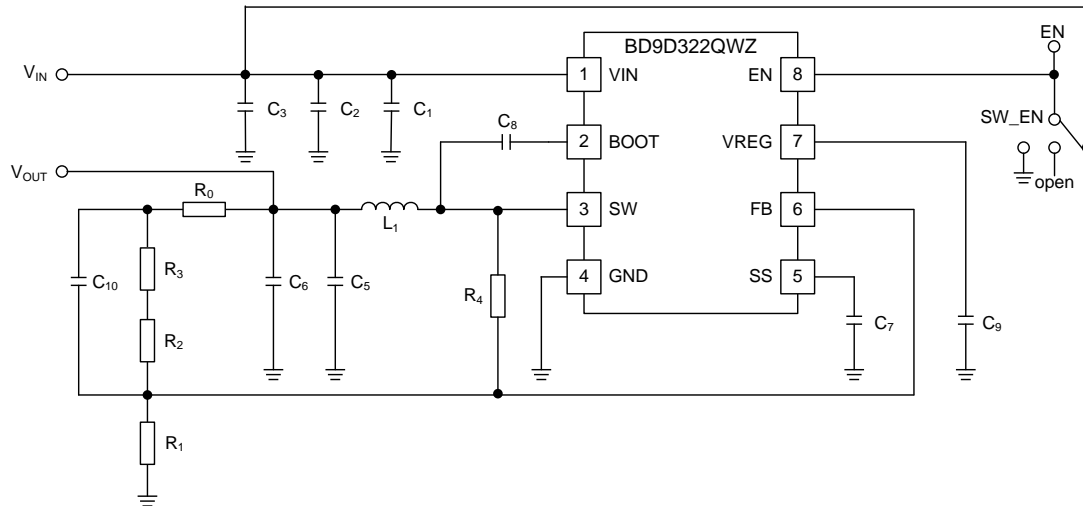

Figure 52. Application Circuit

Table 3. Recommended Component Values

Part No	Value	Company	Part Name
L ₁	2.2μH	Murata	FDSD0518-H-2R2M
C ₁ (Note 1)	0.1μF	Murata	GRM188R71H104KA93D
C ₂ (Note 2)	10μF	Murata	GRM32DB31E106KA75L
C ₃ (Note 2)	10μF	Murata	GRM32DB31E106KA75L
C ₅ (Note 3)	22μF	Murata	GRM21BB30J226ME38L
C ₆ (Note 3)	22μF	Murata	GRM21BB30J226ME38L
C ₇	3300pF	Murata	GRM155B11H332KA01
C ₈	0.1μF	Murata	GRM188R71H104KA93D
C ₉	1μF	Murata	GRM188B11A105KA61D
C ₁₀	47pF	Murata	GRM1552C1E470JA01
R ₀	0Ω	ROHM	MCR01MZPJ000
R ₁	22kΩ	ROHM	MCR01MZPF2202
R ₂	30kΩ	ROHM	MCR01MZPF3002
R ₃	0Ω	ROHM	MCR01MZPJ000
R ₄	OPEN	-	-

(Note 1) In order to reduce the influence of high frequency noise, arrange the 0.1 μF ceramic capacitor as close as possible to the VIN pin and GND pin.
 (Note 2) For capacitance of input capacitor, take temperature characteristics, DC bias characteristics, etc. into consideration to set minimum value to no less than 4.7μF. When V_{IN} is lower than 7V at normal state, add capacitor same as C₂ to C₃.
 (Note 3) In case capacitance value fluctuates due to temperature characteristics, DC bias characteristics, etc. of output capacitor, Loop Response may fluctuate. Please confirm on actual equipment. When selecting a capacitor, confirm the characteristics of the capacitor in its datasheet, Please use capacitors such as ceramic type are recommended for output capacitor.

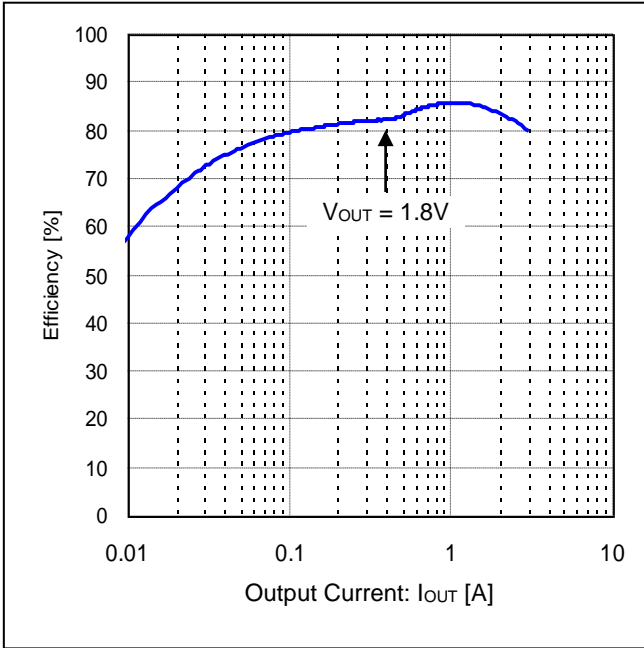

Figure 53. Efficiency vs Output Current
(VIN = 12V, VOUT = 1.8V)

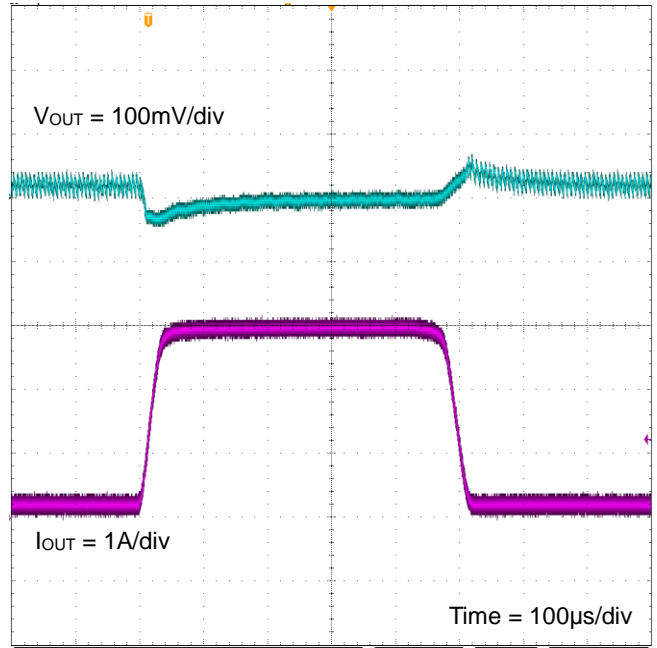

Figure 54. Load Transient Response IOUT = 0.1A - 3A
(VIN = 12V, VOUT = 1.8V)

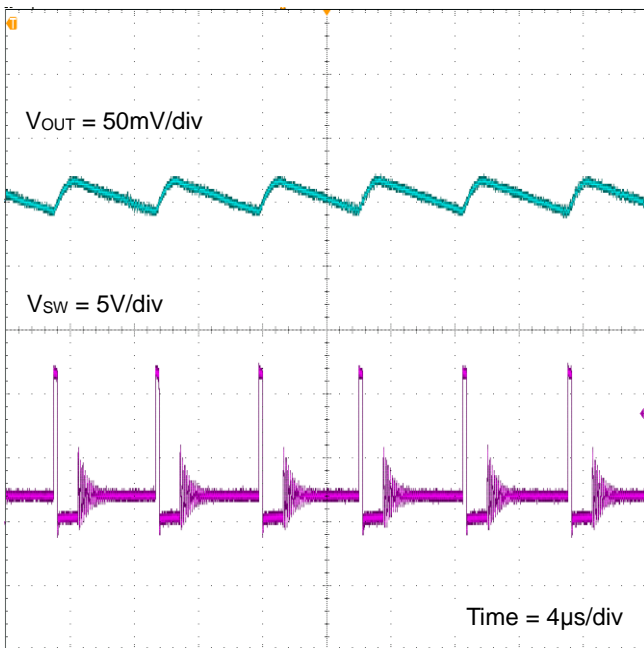

Figure 55. VOUT Ripple IOUT = 0.1A
(VIN = 12V, VOUT = 1.8 V)

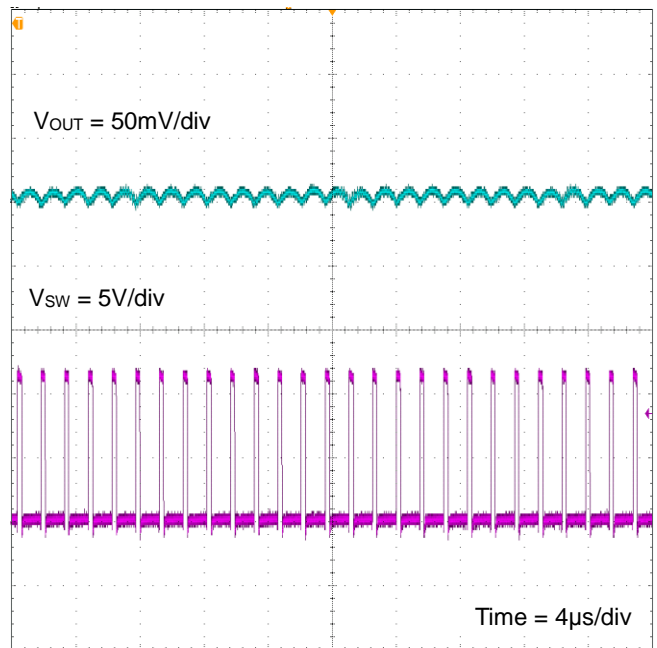

Figure 56. VOUT Ripple IOUT = 3.0A
(VIN = 12V, VOUT = 1.8V)

Application Example (V_{OUT} = 1.2V)

Parameter	Symbol	Specification Example
Input Voltage	V _{IN}	12V
Output Voltage	V _{OUT}	1.2V
Switching Frequency	f _{osc}	700kHz(Typ)
Maximum Output Current	I _{OUTMAX}	3A
Operating Temperature Range	Topr	-40°C to +85°C

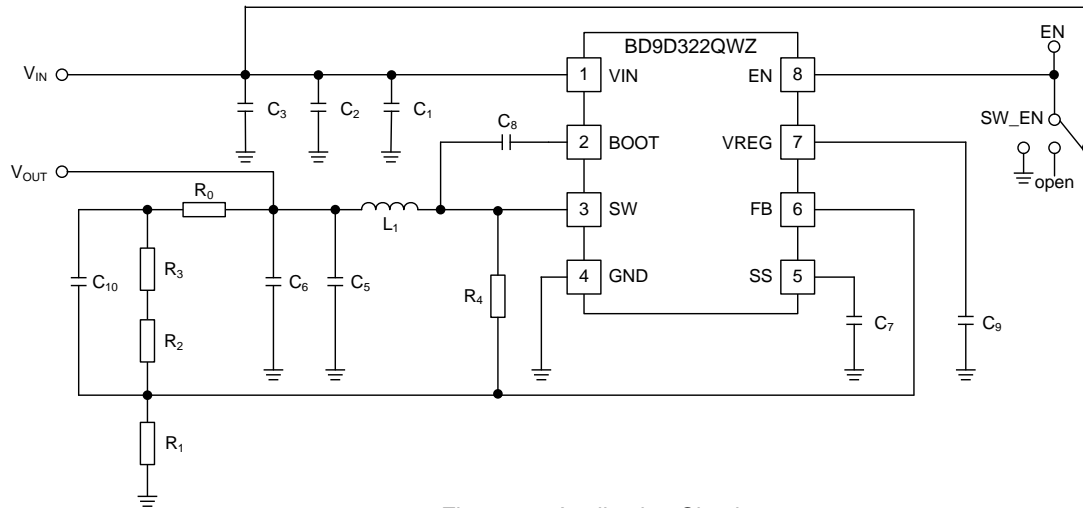

Figure 57. Application Circuit

Table 4. Recommended Component Values

Part No	Value	Company	Part Name
L ₁	1.5μH	Murata	FDSD0518-H-1R5M
C ₁ (Note 1)	0.1μF	Murata	GRM188R71H104KA93D
C ₂ (Note 2)	10μF	Murata	GRM32DB31E106KA75L
C ₃ (Note 2)	10μF	Murata	GRM32DB31E106KA75L
C ₅ (Note 3)	22μF	Murata	GRM31CB31A226ME19L
C ₆ (Note 3)	22μF	Murata	GRM31CB31A226ME19L
C ₇	3300pF	Murata	GRM155B11H332KA01
C ₈	0.1μF	Murata	GRM188R71H104KA93D
C ₉	1μF	Murata	GRM188B11A105KA61D
C ₁₀	220pF	Murata	GRM155B11H221KA01
R ₀	0Ω	ROHM	MCR01MZPJ000
R ₁	10kΩ	ROHM	MCR01MZPF1002
R ₂	4.7kΩ	ROHM	MCR01MZPF4701
R ₃	1kΩ	ROHM	MCR01MZPF1001
R ₄	300kΩ	ROHM	MCR01MZPF3003

- (Note 1) In order to reduce the influence of high frequency noise, arrange the 0.1μF ceramic capacitor as close as possible to the VIN pin and GND pin.
- (Note 2) For capacitance of input capacitor, take temperature characteristics, DC bias characteristics, etc. into consideration to set minimum value to no less than 4.7μF. When VIN is lower than 7V at normal state, add capacitor same as C₂ to C₃.
- (Note 3) In case capacitance value fluctuates due to temperature characteristics, DC bias characteristics, etc. of output capacitor, Loop Response may fluctuate. Please confirm on actual equipment. When selecting a capacitor, confirm the characteristics of the capacitor in its datasheet, Please use capacitors such as ceramic type are recommended for output capacitor.

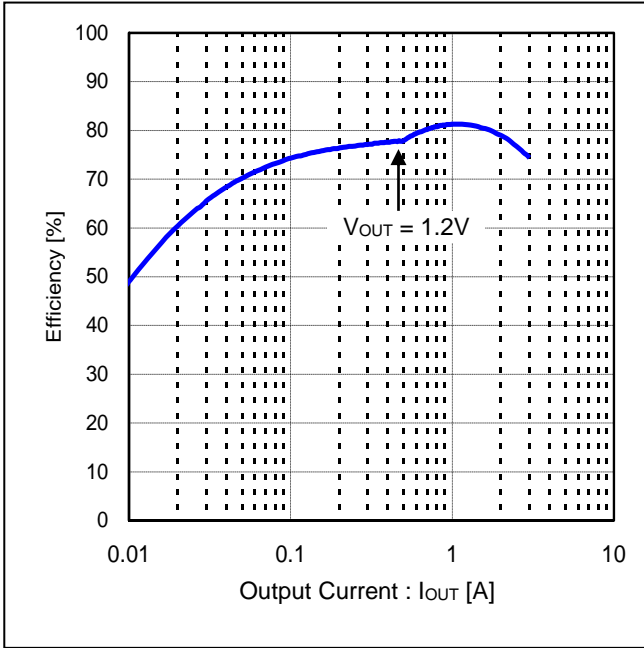

Figure 58. Efficiency vs Output Current
($V_{IN} = 12V, V_{OUT} = 1.2V$)

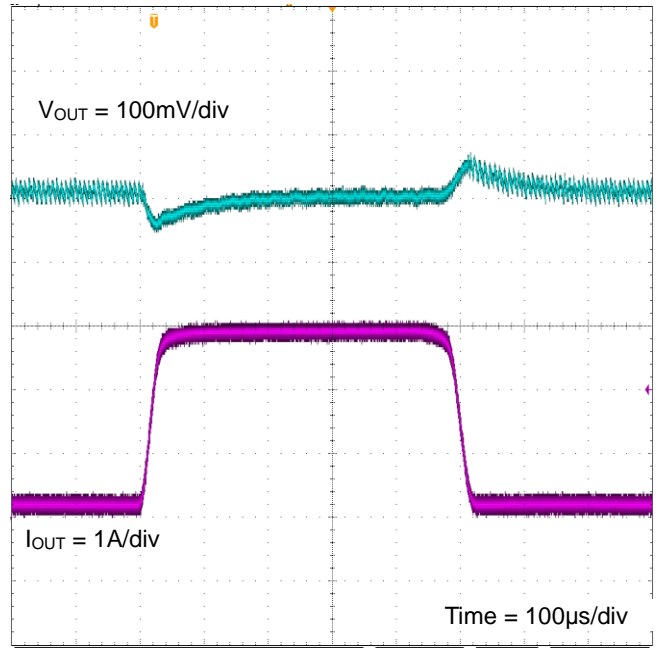

Figure 59. Load Transient Response $I_{OUT} = 0.1A - 3A$
($V_{IN} = 12V, V_{OUT} = 1.2V$)

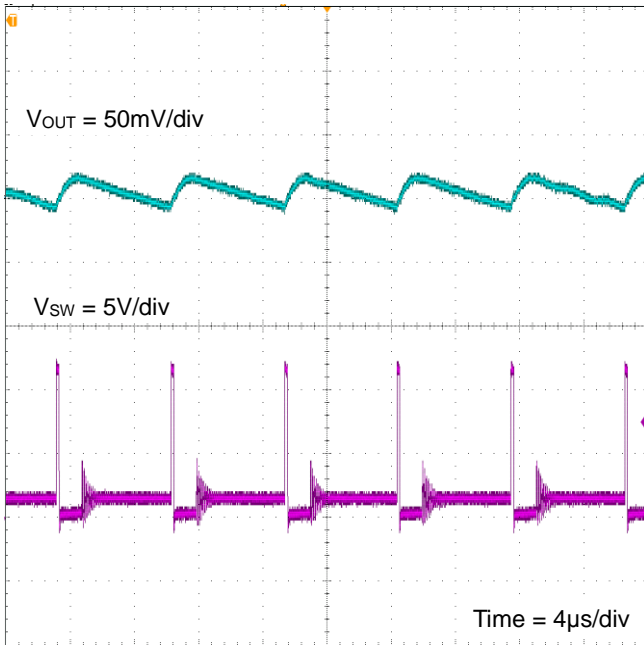

Figure 60. V_{OUT} Ripple $I_{OUT} = 0.1A$
($V_{IN}=12V, V_{OUT}=1.2 V$)

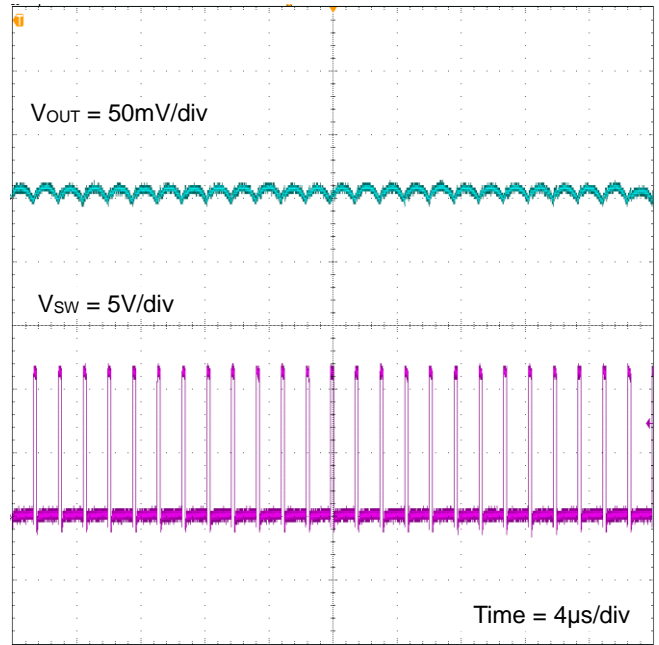

Figure 61. V_{OUT} Ripple $I_{OUT} = 3.0A$
($V_{IN} = 12V, V_{OUT} = 1.2V$)

Selection of Components Externally Connected

About the application except the recommendation, please contact us.

1. Output LC Filter Constant

The DC/DC converter requires an LC filter for smoothing the output voltage in order to supply a continuous current to the load. Selecting an inductor with a large inductance causes the ripple current ΔI_L that flows into the inductor to be small. However, decreasing the ripple voltage generated in the output is not advantageous in terms of the load transient response characteristic. An inductor with a small inductance improves the load transient response characteristic but causes the inductor ripple current to be large which increases the ripple voltage in the output voltage, showing a trade-OFF relationship. Please use recommended inductor values.

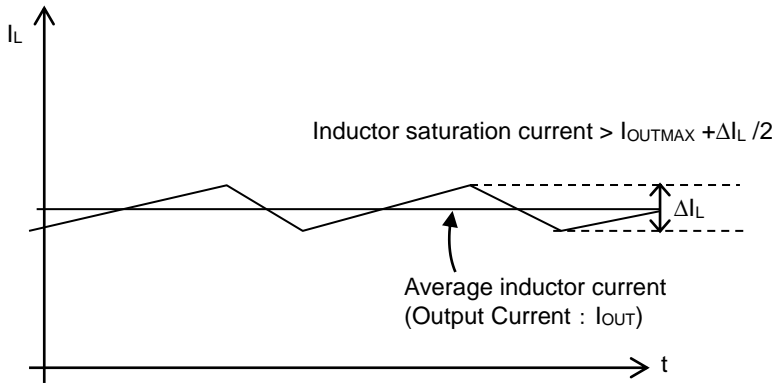

Figure 62. Waveform of Current through Inductor

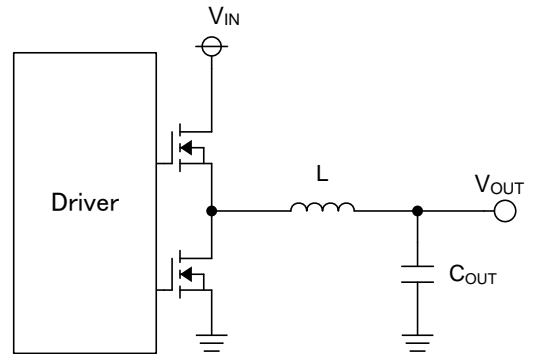

Figure 63. Output LC Filter Circuit

Here, select an inductance so that the size of the ripple current component of the inductor will be 20% to 50% of the Max output current (3A).

Now calculating with $V_{IN} = 12V$, $V_{OUT} = 1.8V$, switching frequency $f_{OSC} = 700kHz$, ΔI_L is 1.0A, inductance value, that can be used is calculated as follows:

$$L = V_{OUT} \times (V_{IN} - V_{OUT}) \times \frac{1}{V_{IN} \times f_{OSC} \times \Delta I_L} = 2.19 \approx 2.2 \text{ } [\mu H]$$

Also for saturation current of inductor, select the one with larger current than maximum output current (I_{OUTMAX}) added by 1/2 of inductor ripple current ΔI_L .

Output capacitor C_{OUT} affects output ripple voltage characteristics. Select output capacitor C_{OUT} so that necessary ripple voltage characteristics are satisfied.

The output ripple voltage can be represented by the following equation.

$$\Delta V_{RPL} = \Delta I_L \times (R_{ESR} + \frac{1}{8 \times C_{OUT} \times f_{OSC}}) \text{ } [V]$$

R_{ESR} is the Equivalent Series Resistance (ESR) of the output capacitor.

With $C_{OUT} = 44\mu F$, $R_{ESR} = 10m\Omega$ the output ripple voltage is calculated as follows:

$$\Delta V_{RPL} = 1.0 \times (10m + \frac{1}{8 \times 44\mu \times 700k}) = 14.06 \text{ } [mV]$$

※The capacitor rating must allow a sufficient margin with respect to the output voltage.
 The output ripple voltage is decreased with a smaller ESR capacitor.
 Considering temperature and DC bias characteristics, please use ceramic capacitor with 22μF to 100μF capacity.

※Pay attention to total capacitance value, when additional capacitor C_{LOAD} is connected in addition to output capacitor C_{OUT}. Then, please determine C_{LOAD} and soft start time t_{SS} (Refer to 4. Soft Start Setting) as satisfying the following equation.

$$C_{OUT} + C_{LOAD} \leq \frac{(I_{OCP} - I_{OUT}) \times t_{SS}}{V_{OUT}} \quad [F]$$

Where:
 I_{OCP} is the Over Current Protection Current limit value

2. Output Voltage Setting

The output voltage value is set by the feedback resistance ratio.

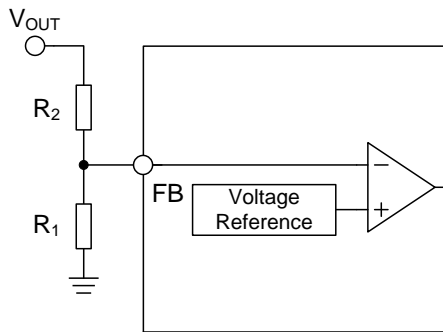

$$V_{OUT} = \frac{R_1 + R_2}{R_1} \times 0.765 \quad [V]$$

BD9D322QWZ operates under the condition which satisfies the following equation.

$$0.07 \leq \frac{V_{OUT}}{V_{IN}} \leq 0.65$$

Figure 64. Feedback Resistor Circuit

3. Input Capacitor

For input capacitor, use a ceramic capacitor. It is more effective, the closer it is to the VIN pin and GND pin. Please consider the derating for a ceramic capacitor when usage. For normal setting, 10μF is recommended, but with larger value, input ripple voltage can be further reduced. Also, considering temperature and DC bias characteristics, do not use capacity less than 4.7μF. In order to reduce the influence of high frequency noise, place 0.1μF ceramic capacitor close to VIN pin and GND pin as much as possible. When V_{IN} is lower than 7V at normal state, double the value of input capacitor.

4. Soft Start Setting

Turning the EN terminal signal High activates the soft start function. This makes output voltage to rise gradually while controlling current at start-up. This prevents output voltage overshoot and inrush current. The rise time depends on the value of the capacitor connected to the SS terminal.

$$t_D = \frac{C_{SS} \times V_{TH}}{I_{SSC}} \quad [\text{s}]$$

$$t_{SS} = \frac{C_{SS} \times V_{FB} \times 1.15}{I_{SSC}} \quad [\text{s}]$$

Where:

t_D is the Soft Start Delay Time

t_{SS} is the Soft Start Time

C_{SS} is the Capacitor connected to SS terminal

V_{FB} is the FB Terminal Voltage (0.765V Typ)

V_{TH} is the Internal MOS threshold voltage (0.7V Typ)

I_{SSC} is the SS Charge Current (2.0 μ A Typ)

With $C_{SS} = 3300\text{pF}$,

$$\begin{aligned} t_D &= (3300\text{pF} \times 0.7\text{V}) / 2.0\mu\text{A} \\ &= 1.16\text{ms} \end{aligned}$$

$$\begin{aligned} t_{SS} &= (3300\text{pF} \times 0.765\text{V} \times 1.15) / 2.0\mu\text{A} \\ &= 1.45\text{ms} \end{aligned}$$

5. Bootstrap Capacitor

Connect 0.1 μ F ceramic capacitor between SW pin and BOOT pin.

6. VREG Capacitor

Connect 1 μ F ceramic capacitor to ground.

PCB Layout Design

In the step-down DC/DC converter, a large pulse current flows into two loops. The first loop is the one into which the current flows when the High Side MOSFET is turned ON. The flow starts from the input capacitor C_{IN} , runs through the MOSFET, inductor L and output capacitor C_{OUT} and back to ground of C_{IN} via ground of C_{OUT} . The second loop is the one into which the current flows when the Low Side MOSFET is turned ON. The flow starts from the Low Side MOSFET, runs through the inductor L and output capacitor C_{OUT} and back to ground of the Low Side MOSFET via ground of C_{OUT} . Route these two loops as thick and as short as possible to allow noise to be reduced for improved efficiency. It is recommended to connect the input and output capacitors directly to the ground plane. The PCB layout has a great influence on the DC/DC converter in terms of all of the heat generation, noise and efficiency characteristics.

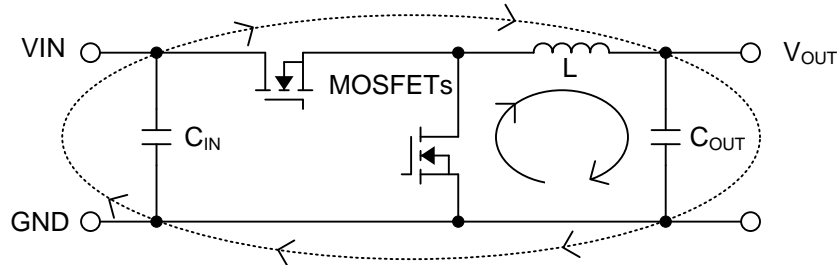

Figure 65. Current Loop of Buck DC/DC Converter

Accordingly, design the PCB layout considering the following points.

1. Connect an input capacitor as close as possible to the IC VIN terminal and GND terminal on the same plane as the IC.
2. If there is any unused area on the PCB, provide a copper foil plane for the ground node to assist heat dissipation from the IC and the surrounding components.
3. Switching nodes such as SW are susceptible to noise due to AC coupling with other nodes. Route the inductor pattern as thick and as short as possible.
4. Provide lines connected to FB and SS far from the SW nodes.
5. Place the output capacitor away from the input capacitor in order to avoid the effect of harmonic noise from the input.

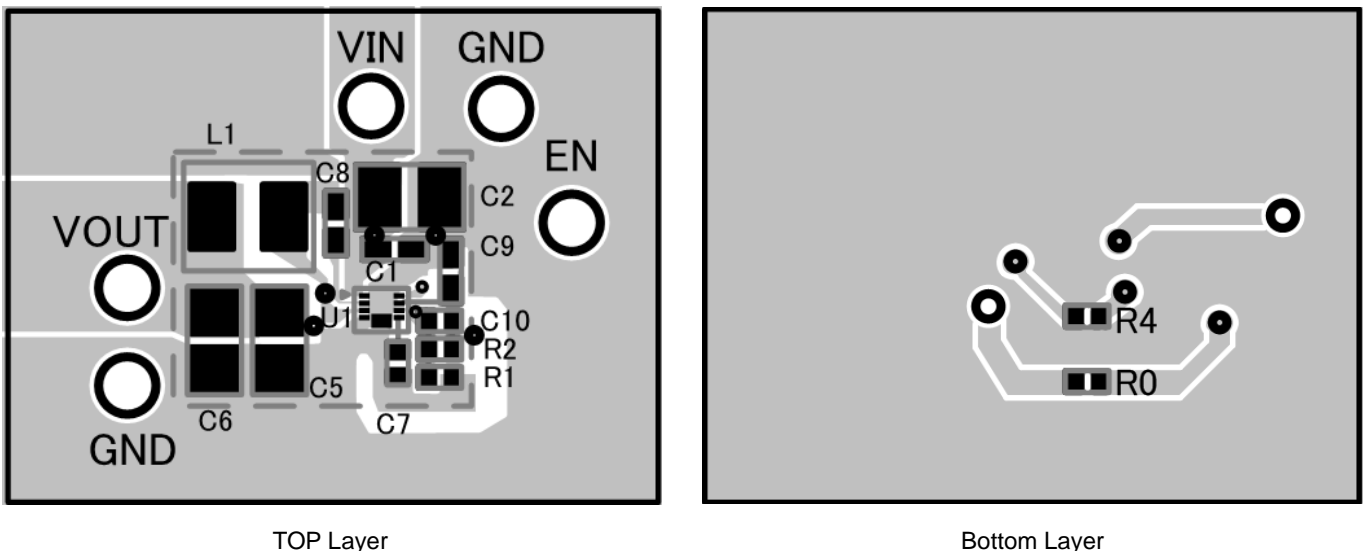

Figure 66. Example of PCB Layout

I/O Equivalence Circuits

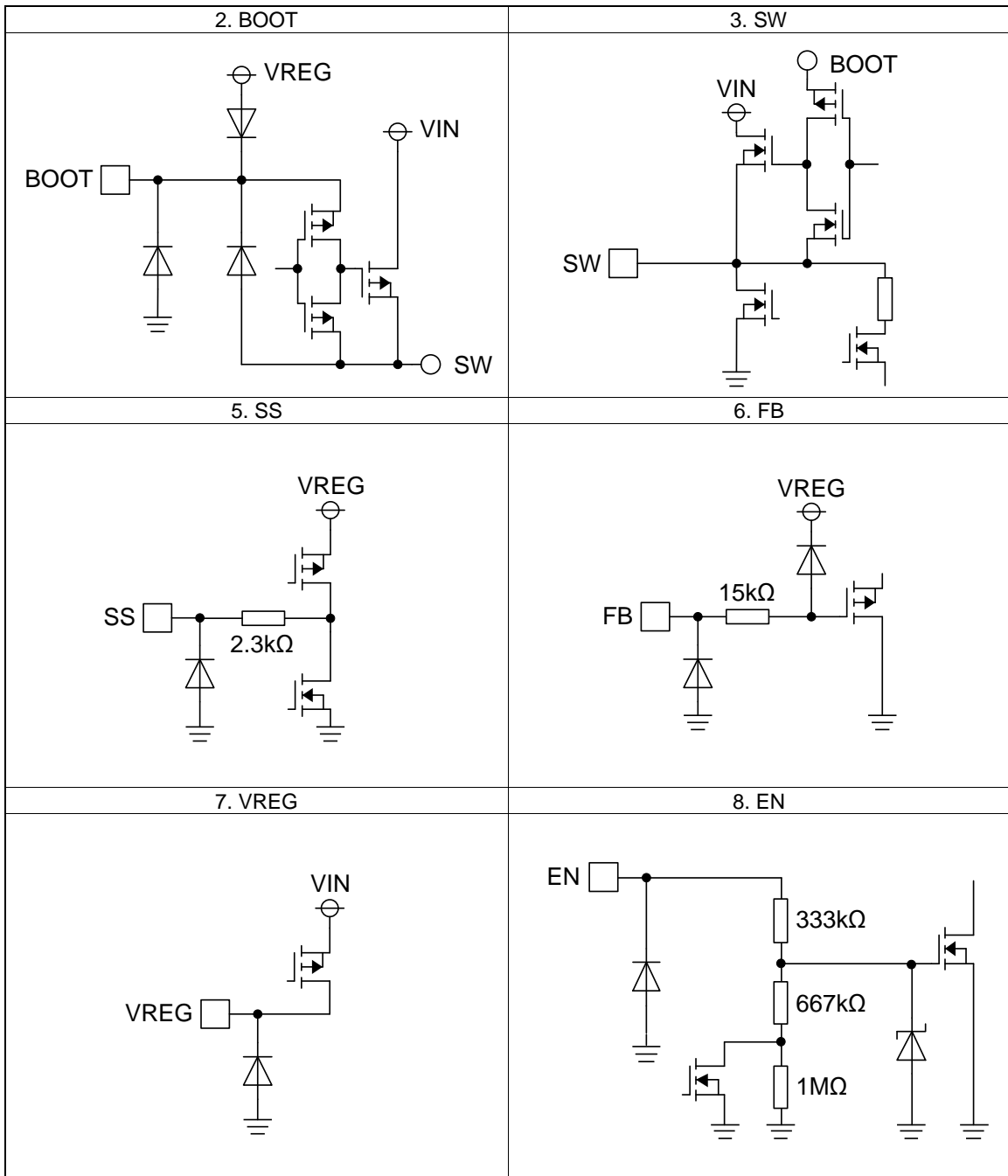

Figure 67. I/O Equivalence Circuits

Operational Notes

1. Reverse Connection of Power Supply

Connecting the power supply in reverse polarity can damage the IC. Take precautions against reverse polarity when connecting the power supply, such as mounting an external diode between the power supply and the IC's power supply pins.

2. Power Supply Lines

Design the PCB layout pattern to provide low impedance supply lines. Separate the ground and supply lines of the digital and analog blocks to prevent noise in the ground and supply lines of the digital block from affecting the analog block. Furthermore, connect a capacitor to ground at all power supply pins. Consider the effect of temperature and aging on the capacitance value when using electrolytic capacitors.

3. Ground Voltage

Ensure that no pins are at a voltage below that of the ground pin at any time, even during transient condition. However, pins that drive inductive loads (e.g. motor driver outputs, DC-DC converter outputs) may inevitably go below ground due to back EMF or electromotive force. In such cases, the user should make sure that such voltages going below ground will not cause the IC and the system to malfunction by examining carefully all relevant factors and conditions such as motor characteristics, supply voltage, operating frequency and PCB wiring to name a few.

4. Ground Wiring Pattern

When using both small-signal and large-current ground traces, the two ground traces should be routed separately but connected to a single ground at the reference point of the application board to avoid fluctuations in the small-signal ground caused by large currents. Also ensure that the ground traces of external components do not cause variations on the ground voltage. The ground lines must be as short and thick as possible to reduce line impedance.

5. Recommended Operating Conditions

The function and operation of the IC are guaranteed within the range specified by the recommended operating conditions. The characteristic values are guaranteed only under the conditions of each item specified by the electrical characteristics.

6. Inrush Current

When power is first supplied to the IC, it is possible that the internal logic may be unstable and inrush current may flow instantaneously due to the internal powering sequence and delays, especially if the IC has more than one power supply. Therefore, give special consideration to power coupling capacitance, power wiring, width of ground wiring, and routing of connections.

7. Operation Under Strong Electromagnetic Field

Operating the IC in the presence of a strong electromagnetic field may cause the IC to malfunction.

8. Testing on Application Boards

When testing the IC on an application board, connecting a capacitor directly to a low-impedance output pin may subject the IC to stress. Always discharge capacitors completely after each process or step. The IC's power supply should always be turned off completely before connecting or removing it from the test setup during the inspection process. To prevent damage from static discharge, ground the IC during assembly and use similar precautions during transport and storage.

9. Inter-pin Short and Mounting Errors

Ensure that the direction and position are correct when mounting the IC on the PCB. Incorrect mounting may result in damaging the IC. Avoid nearby pins being shorted to each other especially to ground, power supply and output pin. Inter-pin shorts could be due to many reasons such as metal particles, water droplets (in very humid environment) and unintentional solder bridge deposited in between pins during assembly to name a few.

10. Unused Input Pins

Input pins of an IC are often connected to the gate of a MOS transistor. The gate has extremely high impedance and extremely low capacitance. If left unconnected, the electric field from the outside can easily charge it. The small charge acquired in this way is enough to produce a significant effect on the conduction through the transistor and cause unexpected operation of the IC. So unless otherwise specified, unused input pins should be connected to the power supply or ground line.

Operational Notes – continued

11. Regarding the Input Pin of the IC

This monolithic IC contains P+ isolation and P substrate layers between adjacent elements in order to keep them isolated. P-N junctions are formed at the intersection of the P layers with the N layers of other elements, creating a parasitic diode or transistor. For example (refer to figure below):

When $GND > Pin A$ and $GND > Pin B$, the P-N junction operates as a parasitic diode.
 When $GND > Pin B$, the P-N junction operates as a parasitic transistor.

Parasitic diodes inevitably occur in the structure of the IC. The operation of parasitic diodes can result in mutual interference among circuits, operational faults, or physical damage. Therefore, conditions that cause these diodes to operate, such as applying a voltage lower than the GND voltage to an input pin (and thus to the P substrate) should be avoided.

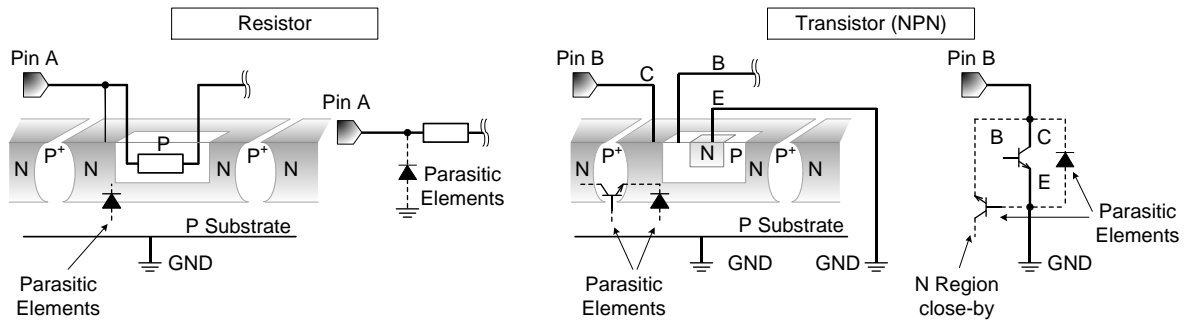

Figure 68. Example of monolithic IC structure

12. Ceramic Capacitor

When using a ceramic capacitor, determine a capacitance value considering the change of capacitance with temperature and the decrease in nominal capacitance due to DC bias and others.

13. Area of Safe Operation (ASO)

Operate the IC such that the output voltage, output current, and the maximum junction temperature rating are all within the Area of Safe Operation (ASO).

14. Thermal Shutdown Circuit(TSD)

This IC has a built-in thermal shutdown circuit that prevents heat damage to the IC. Normal operation should always be within the IC's maximum junction temperature rating. If however the rating is exceeded for a continued period, the junction temperature (T_j) will rise which will activate the TSD circuit that will turn OFF all output pins. When the T_j falls below the TSD threshold, the circuits are automatically restored to normal operation.

Note that the TSD circuit operates in a situation that exceeds the absolute maximum ratings and therefore, under no circumstances, should the TSD circuit be used in a set design or for any purpose other than protecting the IC from heat damage.

15. Over Current Protection Circuit (OCP)

This IC incorporates an integrated overcurrent protection circuit that is activated when the load is shorted. This protection circuit is effective in preventing damage due to sudden and unexpected incidents. However, the IC should not be used in applications characterized by continuous operation or transitioning of the protection circuit.

16. Disturbance Light

In a device where a portion of silicon is exposed to light such as in a WL-CSP and chip products, IC characteristics may be affected due to photoelectric effect. For this reason, it is recommended to come up with countermeasures that will prevent the chip from being exposed to light.

Ordering Information

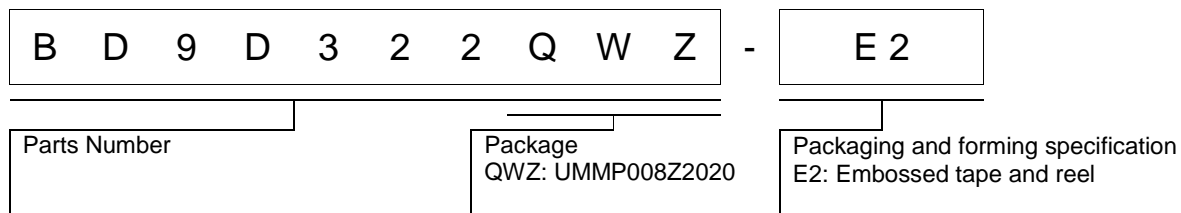

Marking Diagram

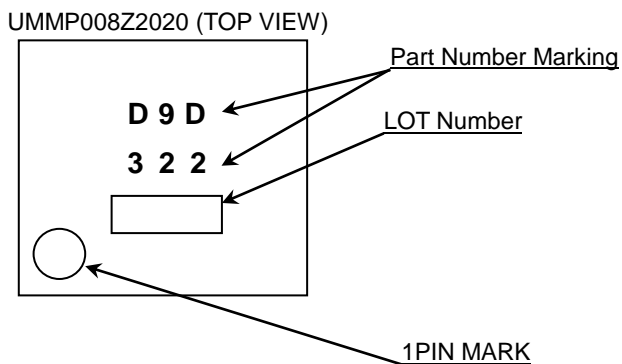

Physical Dimension, Tape and Reel Information

Package Name	UMMP008Z2020
--------------	--------------

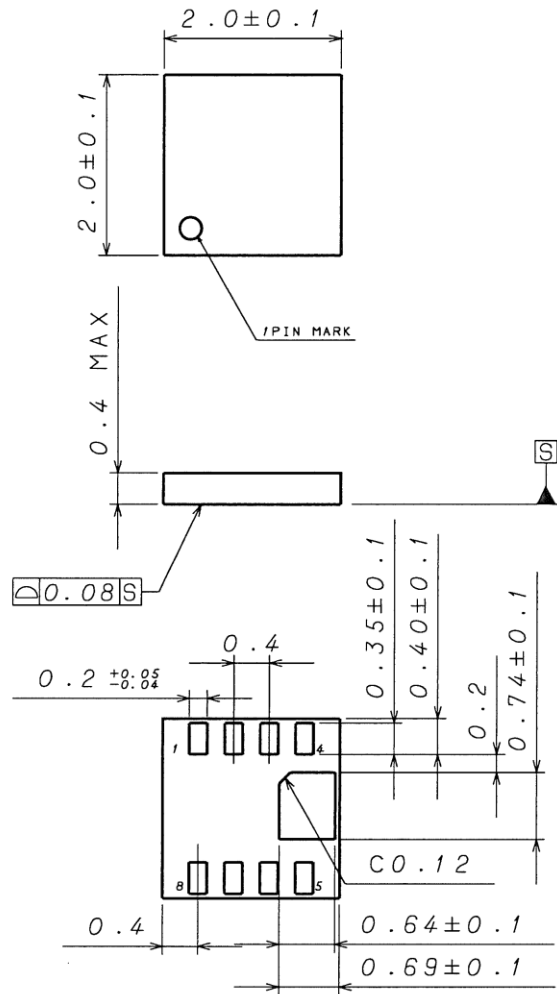

(UNIT : mm)

PKG : UMMP008Z2020

< Tape and Reel Information >

Tape	Embossed carrier tape
Quantity	4000pcs
Direction of feed	E2 The direction is the pin 1 of product is at the upper left when you hold reel on the left hand and you pull out the tape on the right hand

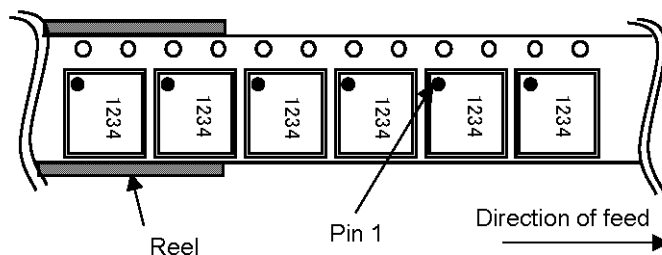

Revision History

Date	Revision	Changes
07.Apr.2017	001	New Release

Notice

Precaution on using ROHM Products

- Our Products are designed and manufactured for application in ordinary electronic equipments (such as AV equipment, OA equipment, telecommunication equipment, home electronic appliances, amusement equipment, etc.). If you intend to use our Products in devices requiring extremely high reliability (such as medical equipment ^(Note 1), transport equipment, traffic equipment, aircraft/spacecraft, nuclear power controllers, fuel controllers, car equipment including car accessories, safety devices, etc.) and whose malfunction or failure may cause loss of human life, bodily injury or serious damage to property ("Specific Applications"), please consult with the ROHM sales representative in advance. Unless otherwise agreed in writing by ROHM in advance, ROHM shall not be in any way responsible or liable for any damages, expenses or losses incurred by you or third parties arising from the use of any ROHM's Products for Specific Applications.

(Note1) Medical Equipment Classification of the Specific Applications

JAPAN	USA	EU	CHINA
CLASS III	CLASS III	CLASS II b	CLASS III
CLASS IV		CLASS III	

- ROHM designs and manufactures its Products subject to strict quality control system. However, semiconductor products can fail or malfunction at a certain rate. Please be sure to implement, at your own responsibilities, adequate safety measures including but not limited to fail-safe design against the physical injury, damage to any property, which a failure or malfunction of our Products may cause. The following are examples of safety measures:
 - Installation of protection circuits or other protective devices to improve system safety
 - Installation of redundant circuits to reduce the impact of single or multiple circuit failure
- Our Products are designed and manufactured for use under standard conditions and not under any special or extraordinary environments or conditions, as exemplified below. Accordingly, ROHM shall not be in any way responsible or liable for any damages, expenses or losses arising from the use of any ROHM's Products under any special or extraordinary environments or conditions. If you intend to use our Products under any special or extraordinary environments or conditions (as exemplified below), your independent verification and confirmation of product performance, reliability, etc. prior to use, must be necessary:
 - Use of our Products in any types of liquid, including water, oils, chemicals, and organic solvents
 - Use of our Products outdoors or in places where the Products are exposed to direct sunlight or dust
 - Use of our Products in places where the Products are exposed to sea wind or corrosive gases, including Cl₂, H₂S, NH₃, SO₂, and NO₂
 - Use of our Products in places where the Products are exposed to static electricity or electromagnetic waves
 - Use of our Products in proximity to heat-producing components, plastic cords, or other flammable items
 - Sealing or coating our Products with resin or other coating materials
 - Use of our Products without cleaning residue of flux (even if you use no-clean type fluxes, cleaning residue of flux is recommended); or Washing our Products by using water or water-soluble cleaning agents for cleaning residue after soldering
 - Use of the Products in places subject to dew condensation
- The Products are not subject to radiation-proof design.
- Please verify and confirm characteristics of the final or mounted products in using the Products.
- In particular, if a transient load (a large amount of load applied in a short period of time, such as pulse. is applied, confirmation of performance characteristics after on-board mounting is strongly recommended. Avoid applying power exceeding normal rated power; exceeding the power rating under steady-state loading condition may negatively affect product performance and reliability.
- De-rate Power Dissipation depending on ambient temperature. When used in sealed area, confirm that it is the use in the range that does not exceed the maximum junction temperature.
- Confirm that operation temperature is within the specified range described in the product specification.
- ROHM shall not be in any way responsible or liable for failure induced under deviant condition from what is defined in this document.

Precaution for Mounting / Circuit board design

- When a highly active halogenous (chlorine, bromine, etc.) flux is used, the residue of flux may negatively affect product performance and reliability.
- In principle, the reflow soldering method must be used on a surface-mount products, the flow soldering method must be used on a through hole mount products. If the flow soldering method is preferred on a surface-mount products, please consult with the ROHM representative in advance.

For details, please refer to ROHM Mounting specification

Precautions Regarding Application Examples and External Circuits

1. If change is made to the constant of an external circuit, please allow a sufficient margin considering variations of the characteristics of the Products and external components, including transient characteristics, as well as static characteristics.
2. You agree that application notes, reference designs, and associated data and information contained in this document are presented only as guidance for Products use. Therefore, in case you use such information, you are solely responsible for it and you must exercise your own independent verification and judgment in the use of such information contained in this document. ROHM shall not be in any way responsible or liable for any damages, expenses or losses incurred by you or third parties arising from the use of such information.

Precaution for Electrostatic

This Product is electrostatic sensitive product, which may be damaged due to electrostatic discharge. Please take proper caution in your manufacturing process and storage so that voltage exceeding the Products maximum rating will not be applied to Products. Please take special care under dry condition (e.g. Grounding of human body / equipment / solder iron, isolation from charged objects, setting of Ionizer, friction prevention and temperature / humidity control).

Precaution for Storage / Transportation

1. Product performance and soldered connections may deteriorate if the Products are stored in the places where:
 - [a] the Products are exposed to sea winds or corrosive gases, including Cl₂, H₂S, NH₃, SO₂, and NO₂
 - [b] the temperature or humidity exceeds those recommended by ROHM
 - [c] the Products are exposed to direct sunshine or condensation
 - [d] the Products are exposed to high Electrostatic
2. Even under ROHM recommended storage condition, solderability of products out of recommended storage time period may be degraded. It is strongly recommended to confirm solderability before using Products of which storage time is exceeding the recommended storage time period.
3. Store / transport cartons in the correct direction, which is indicated on a carton with a symbol. Otherwise bent leads may occur due to excessive stress applied when dropping of a carton.
4. Use Products within the specified time after opening a humidity barrier bag. Baking is required before using Products of which storage time is exceeding the recommended storage time period.

Precaution for Product Label

A two-dimensional barcode printed on ROHM Products label is for ROHM's internal use only.

Precaution for Disposition

When disposing Products please dispose them properly using an authorized industry waste company.

Precaution for Foreign Exchange and Foreign Trade act

Since concerned goods might be fallen under listed items of export control prescribed by Foreign exchange and Foreign trade act, please consult with ROHM in case of export.

Precaution Regarding Intellectual Property Rights

1. All information and data including but not limited to application example contained in this document is for reference only. ROHM does not warrant that foregoing information or data will not infringe any intellectual property rights or any other rights of any third party regarding such information or data.
2. ROHM shall not have any obligations where the claims, actions or demands arising from the combination of the Products with other articles such as components, circuits, systems or external equipment (including software).
3. No license, expressly or implied, is granted hereby under any intellectual property rights or other rights of ROHM or any third parties with respect to the Products or the information contained in this document. Provided, however, that ROHM will not assert its intellectual property rights or other rights against you or your customers to the extent necessary to manufacture or sell products containing the Products, subject to the terms and conditions herein.

Other Precaution

1. This document may not be reprinted or reproduced, in whole or in part, without prior written consent of ROHM.
2. The Products may not be disassembled, converted, modified, reproduced or otherwise changed without prior written consent of ROHM.
3. In no event shall you use in any way whatsoever the Products and the related technical information contained in the Products or this document for any military purposes, including but not limited to, the development of mass-destruction weapons.
4. The proper names of companies or products described in this document are trademarks or registered trademarks of ROHM, its affiliated companies or third parties.

General Precaution

1. Before you use our Products, you are requested to carefully read this document and fully understand its contents. ROHM shall not be in any way responsible or liable for failure, malfunction or accident arising from the use of any ROHM's Products against warning, caution or note contained in this document.
2. All information contained in this document is current as of the issuing date and subject to change without any prior notice. Before purchasing or using ROHM's Products, please confirm the latest information with a ROHM sales representative.
3. The information contained in this document is provided on an "as is" basis and ROHM does not warrant that all information contained in this document is accurate and/or error-free. ROHM shall not be in any way responsible or liable for any damages, expenses or losses incurred by you or third parties resulting from inaccuracy or errors of or concerning such information.