

# Single-chip Type with Built-in FET Switching Regulator Series Step-down Switching regulators with Built-in Power MOSFET



## BU9002xNUX Series

### ●General Description

The BU9002xNUX are a high efficiency 1MHz synchronous step-down switching regulator with low current PFM mode. It provides up to 1.5A load current and an input voltage range from 4.5V to 5.5V, optimized for various applications with input voltage range up to 5V. BU9002xNUX has a mode control pin that allows the user to select Forced PWM (Pulse Width Modulation) mode or PFM (Pulse Frequency Modulation) and PWM auto change mode utilized power save operation at light load current.

### ●Features

- Fast transient response
- Automatic PFM/PWM operation.
- Forced PWM operation
- Internal Soft Start
- Under voltage lockout
- Over current protection
- Thermal shutdown

### ●Lineup

| Part No.   | Output voltage |
|------------|----------------|
| BU90023NUX | 1.230V         |
| BU90028NUX | 1.175V         |

### ●Applications

- POL, 1Cell Li-ion battery for portable applications , USB accessories

### ●Package(s)

VSON008X2030

W(Typ.) x D(Typ.) x H(Max.)

2.00mm x 3.00mm x 0.60mm



### ●Typical Application Circuit(s)

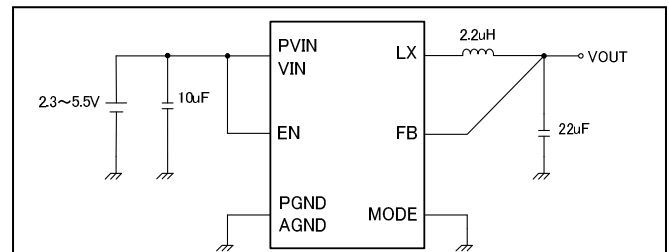

Figure 1. Typical Application Circuit(s)

### ●Pin Configuration(s)

(TOP VIEW)

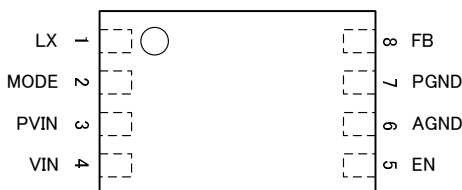

Figure 2. Pin Configuration(s)

### ●Pin Description(s)

| Pin No. | Symbol | Function                   |
|---------|--------|----------------------------|
| 1       | LX     | Inductor connection pin    |
| 2       | MODE   | Forced PWM mode pin        |
| 3       | PVIN   | Power supply input pin     |
| 4       | VIN    | Power supply input pin     |
| 5       | EN     | Enable pin                 |
| 6       | AGND   | GND pin                    |
| 7       | PGND   | GND pin                    |
| 8       | FB     | Feedback voltage input pin |

●Block Diagram(s)

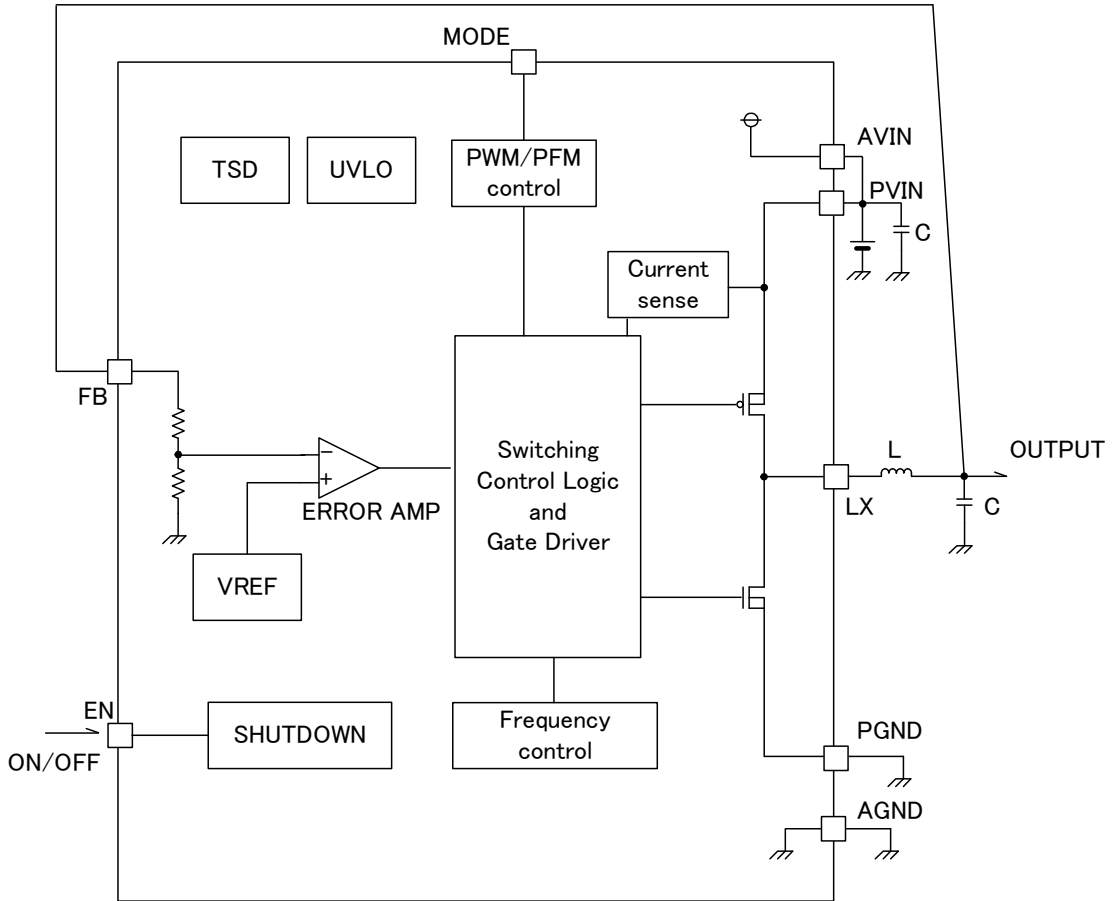

Figure 3. Block Diagram(s)

●Description of Block(s)

The BU9002xNUX are a synchronous step-down DC/DC converter that achieves fast transient response from light load to heavy load by hysteretic PWM control system and current constant PFM control system.

○PWM control

BU9002xNUX operates by hysteretic PWM control. This scheme ensures fast switching, high efficiency, and fast transient response.

When the output voltage is below the VREF voltage, the error comparator output is low to high and turning on P-channel MOSFET until above the VREF voltage and minimum on time.

○PFM control

At light load the regulator and MODE=low, the regulator operates with reduced switching frequency and improves the efficiency. During PFM operation, the output voltage slightly higher than typical output voltage.

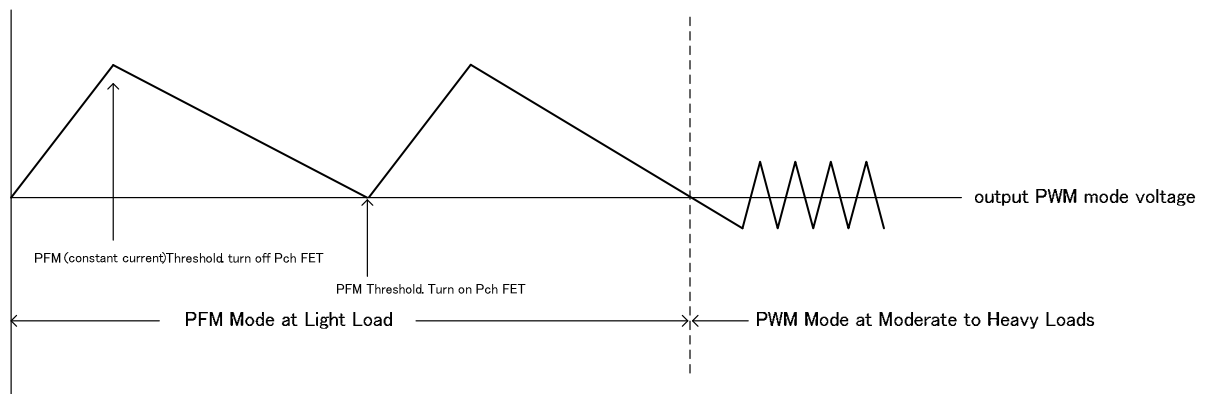

Figure 4. Operation of PFM mode and PWM mode

●Description of operations

1) Shutdown

If the EN input pin set to low (<0.4V), all circuit are shut down and the regulator is standby mode. Do not leave the EN pin floating.

2) Soft start function

The regulator has a soft start circuit that reduces in-rush current at start-up. Typical start up times with a 2.2uF output capacitor is 240usec.

3) Current limit

The BU9002xNUX has a current limit circuit that protects itself and external components during overload condition.

4) UVLO

The BU9002xNUX has a Under Voltage Lock Out circuit that turn off device when VIN>2.05V(typ.)

5) FORCED PWM MODE

Setting MODE pin high (>1.4V) places the regulator in forced PWM. This control provides noise reduction and output stability. Do not leave the MODE pin floating.

6) TSD

The BU9002xNUX has a thermal shutdown feature to protect the device if the junction temperature exceeds 150°C. In thermal shutdown, the DRIVER is disabled. This circuit is only to cut off the IC from thermal runaway, and has not been design to protect or guarantee the IC. Therefore, the user should not plan to activate this circuit with continued operation in mind.

●Absolute Maximum Ratings (Ta=25°C)

| Parameter                           | Symbol               | Rating      | Unit |
|-------------------------------------|----------------------|-------------|------|
| Maximum input power supply voltage  | VIN                  | 7           | V    |
| Maximum voltage at EN, FB, LX, MODE | VEN, VFB, VLX, VMODE | 7           | V    |
| Power dissipation                   | Pd                   | 0.515       | W    |
| Operating temperature range         | Topr                 | -40 to +85  | °C   |
| Storage temperature range           | Tstg                 | -55 to +125 | °C   |
| Junction temperature                | Tjmax                | +125        | °C   |

(\*1) When mounted on the specified PCB (55mm x 63mm), Deducted by 3.9m W/c when used over Ta=25c

●Recommended Operating Rating(s)

| Parameter     | Symbol | Rating |      |      | Unit | Series |
|---------------|--------|--------|------|------|------|--------|
|               |        | Min.   | Typ. | Max. |      |        |
| Input voltage | VIN    | 2.3    | -    | 5.5  | V    |        |

●Electrical Characteristic(s) (unless otherwise specified VIN=5.0V, Ta=25°C)

| Item                         | Symbol        | Rating |       |       | Unit | Condition                                    |                   |
|------------------------------|---------------|--------|-------|-------|------|--|-------------------|
|                              |               | Min.   | Typ.  | Max.  |      |  |                   |
| <b>【Switching regulator】</b> |               |        |       |       |      |  |                   |
| Output voltage accuracy      | VOUTA         | 1.206  | 1.230 | 1.254 | V    | BU90023NUX MODE:H(PWM)                       |                   |
|                              |               | 1.152  | 1.175 | 1.199 |      | BU90028NUX MODE:H(PWM)                       |                   |
| <b>【Soft start】</b>          |               |        |       |       |      |  |                   |
| Soft start time              | Tss           | 120    | 240   | 480   | usec |  |                   |
| <b>【Frequency control】</b>   |               |        |       |       |      |  |                   |
| Switching frequency          | fosc          | 0.8    | 1.0   | 2.0   | MHz  |  |                   |
| <b>【Driver】</b>              |               |        |       |       |      |  |                   |
| PchFET on resistance         | RonP          | -      | 250   | 400   | mOhm | VIN=5.0V                                     |                   |
| NchFET on resistance         | RonN          | -      | 220   | 350   | mOhm | VIN=5.0V                                     |                   |
| <b>【Control】</b>             |               |        |       |       |      |  |                   |
| EN pin control voltage       | Operation     | VENH   | 1.4   | -     | VIN  | V  |                   |
|                              | Non Operation | VENL   | 0     | -     | 0.4  | V  |                   |
| MODE pin control voltage     | Operation     | VMODEH | 1.4   | -     | VIN  | V  | Forced PWM        |
|                              | Non Operation | VMODEL | 0     | -     | 0.4  | V  | Automatic PFM/PWM |
| <b>【UVLO】</b>                |               |        |       |       |      |  |                   |
| Protect threshold voltage    | Uvth          | 1.95   | 2.05  | 2.15  | V    |  |                   |
| Hysteresis                   | Uvhy          | 50     | 100   | 150   | mV   |  |                   |
| <b>【Current limit】</b>       |               |        |       |       |      |  |                   |
| Current limit threshold      | ILIMIT        | 2.2    | 2.5   | 2.8   | A    | PMOS current detect, Open loop               |                   |
| <b>【Output discharge】</b>    |               |        |       |       |      |  |                   |
| Output discharge resistance  | DRES          | 55     | 110   | 220   | Ohm  | EN=0V  |                   |
| <b>【Circuit current】</b>     |               |        |       |       |      |  |                   |
| Operating quiescent current  | IINS          |        | 53    | 75    | uA   | EN:H, MODE:L, VOUT=3.6V forced Not switching |                   |
| Shutdown current             | SHD           | -      | 0     | 1     | uA   | EN=0V  |                   |

●Electrical characteristic curves (Reference data)  
BU90023NUX (1.23V OUTPUT)

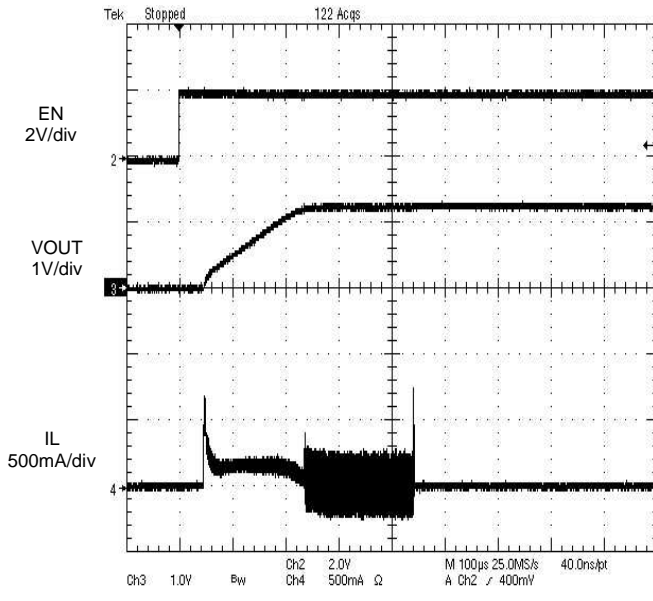

Figure 5. Start up

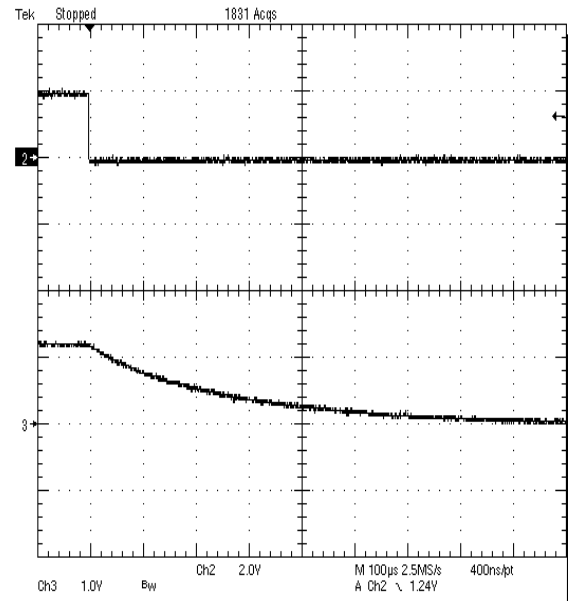

Figure 6. Shut down

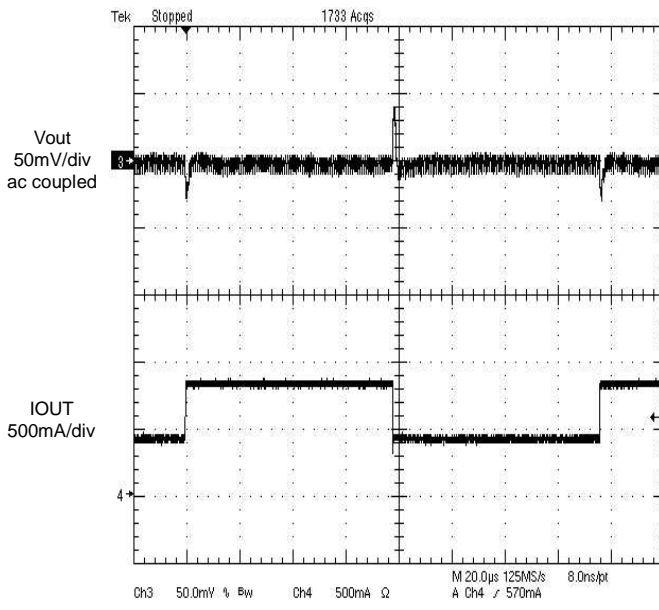

Figure 7. Load transient response 400mA to 800mA  
tr=tf=100ns, MODE : Low

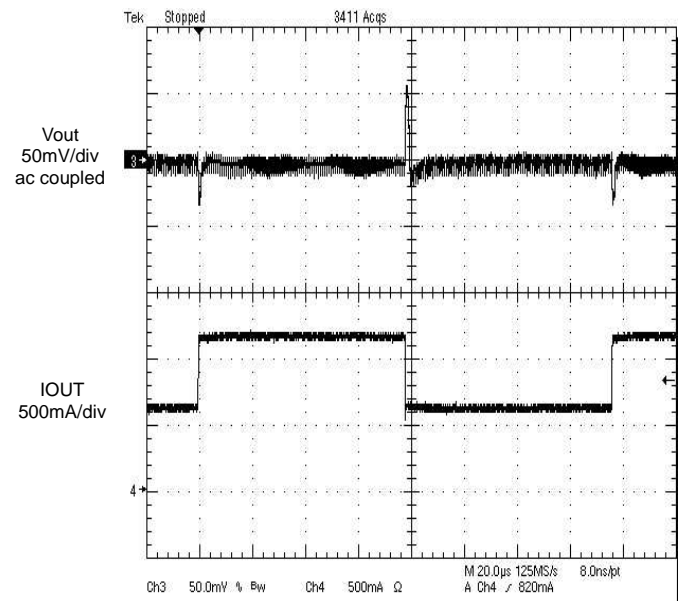

Figure 8. Load transient response 600mA to 1200mA  
tr=tf=100ns, MODE : Low

●Electrical characteristic curves (Reference data)  
 BU90023NUX (1.23V OUTPUT) continued

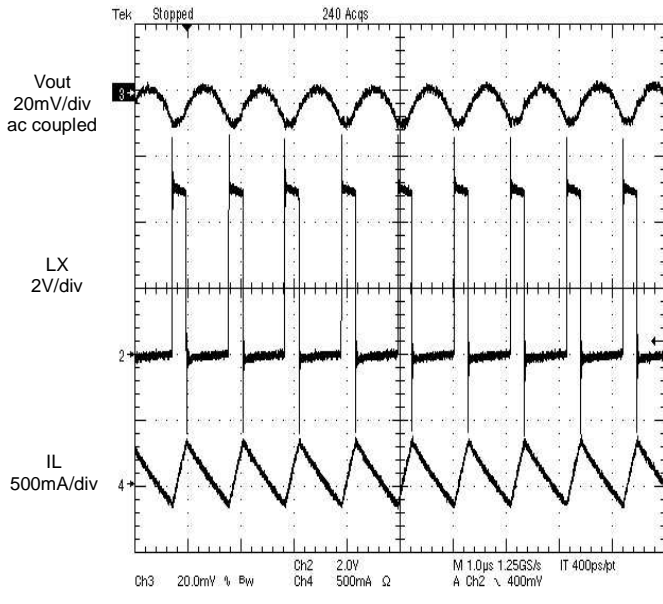

Figure 9. PWM mode  
 Operation Iout=50mA

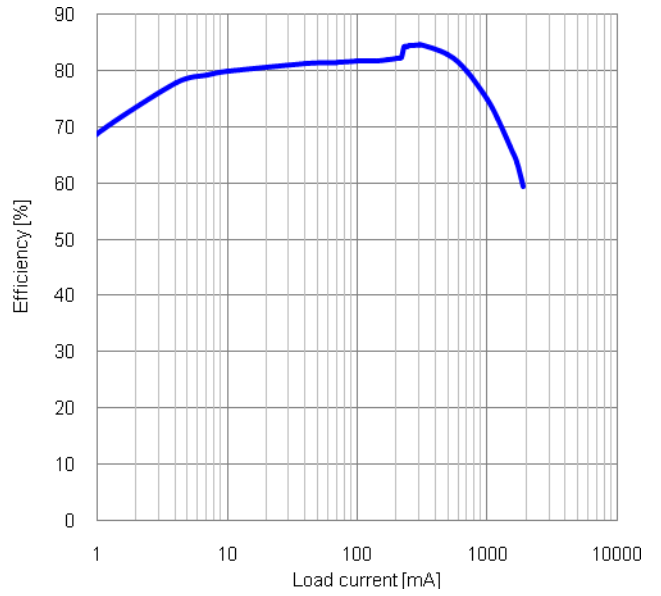

Figure 10. Efficiency vs Load current  
 VIN=5V PWM/PFM Auto mode

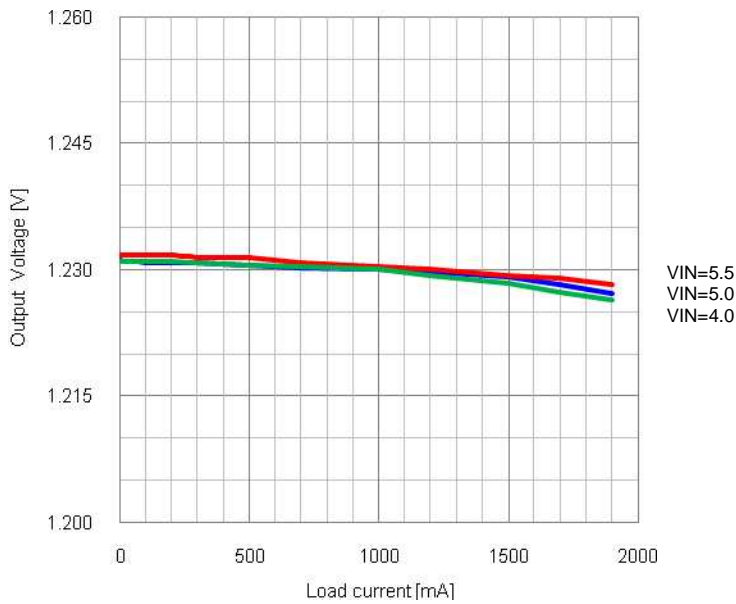

Figure 11. Load regulation  
 PWM mode

●Electrical characteristic curves (Reference data)  
 BU90028NUX (1.175V OUTPUT)

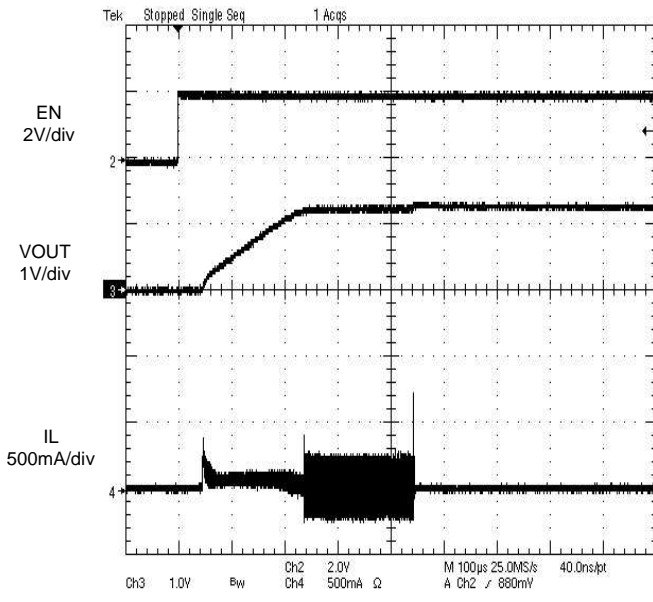

Figure 12. Start up

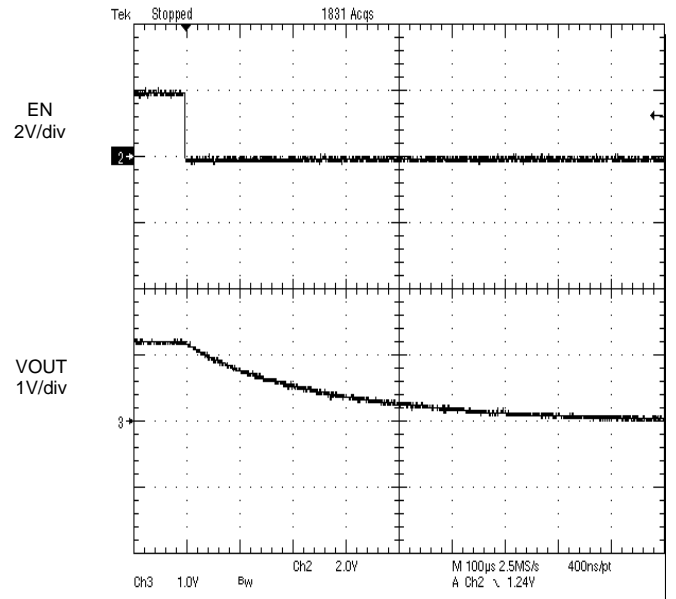

Figure 13. Shut down

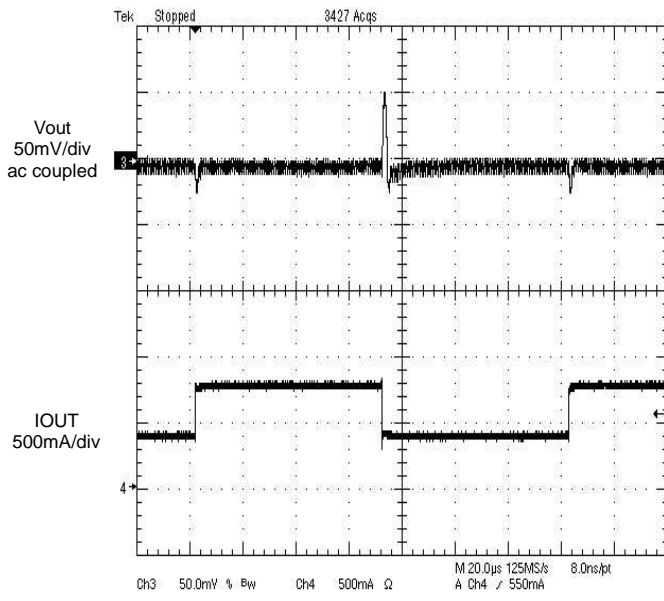

Figure 14. Load transient response 400mA to 800mA  
 $tr=100ns$ , MODE : Low

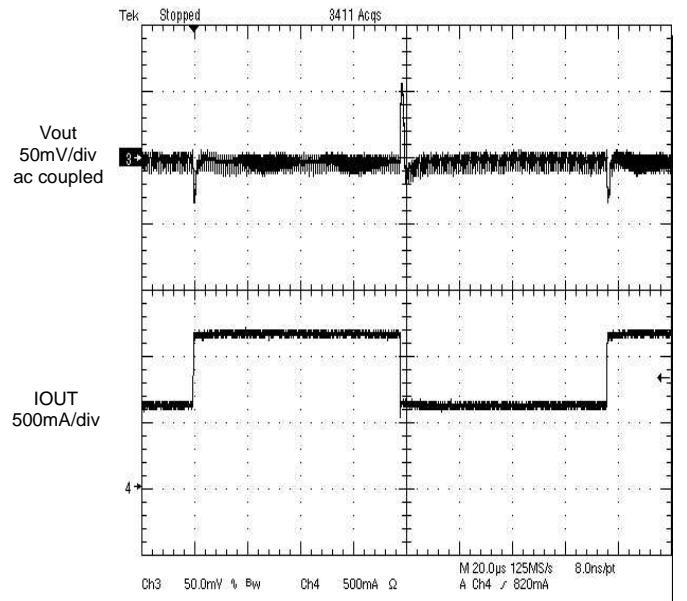

Figure 15. Load transient response 600mA to 1200mA  
 $tr=100ns$ , MODE : Low

●特性データ(参考データ)

BU90028NWX (1.175V 出力) continued

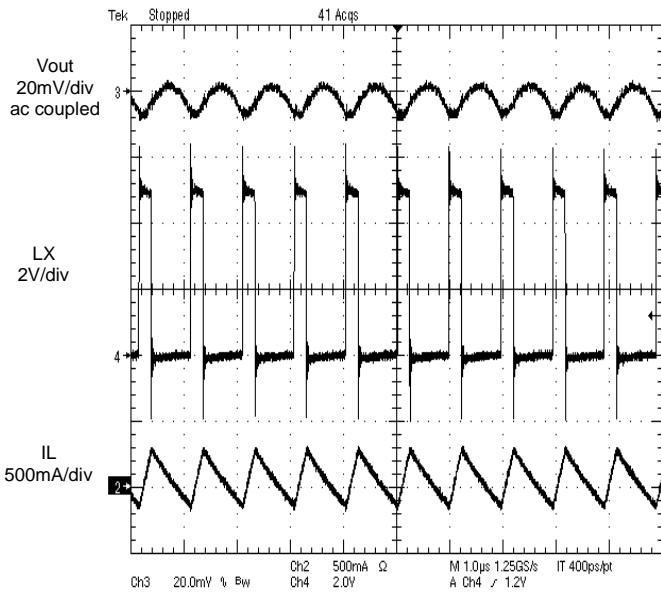

Figure 16. PWM mode  
Operation Iout=50mA

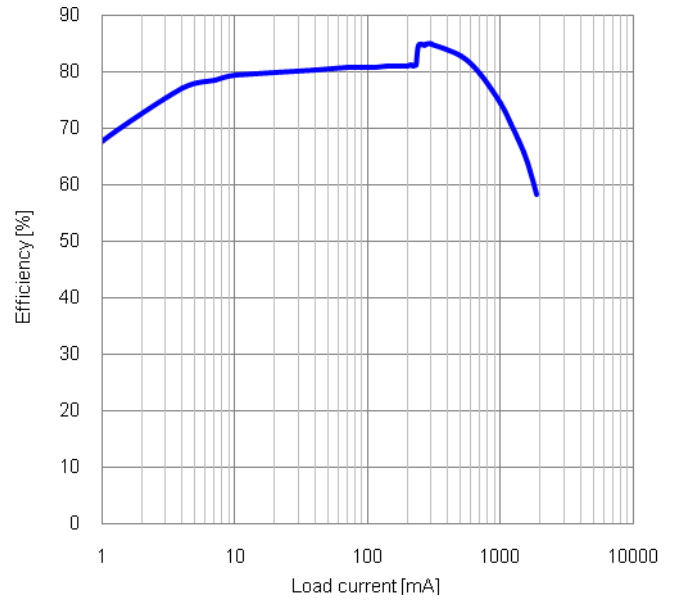

Figure 17. Efficiency vs Load current  
VIN=5V PWM/PFM Auto mode

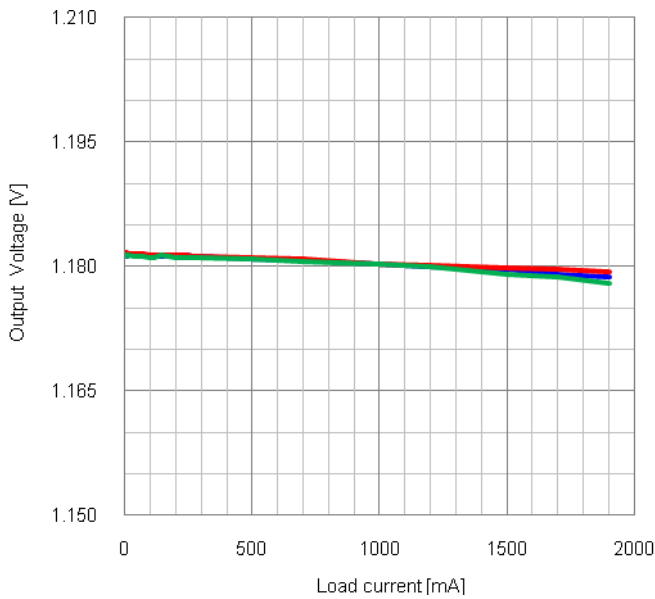

Figure 18. Load regulation  
PWM mode



●PC Board layout

The suggested PCB layout for the BU9002xNUX are shown in Figure. The following guidelines should be used to ensure a proper layout.

- 1) The input capacitor CIN should be connect as closely possible to VIN pin and GND pin.
- 2) From the output voltage to the FB pin line should be as separate as possible.
- 3) COUT and L should be connected as closely as possible. The connection of L to the LX pin should be as short as possible.

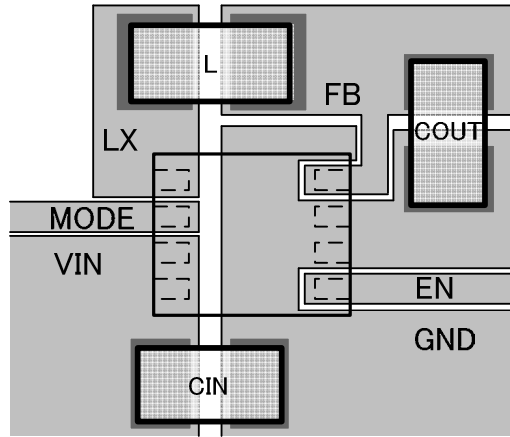

Figure 19. PCB layout

●External parts selection

Inductor selection

The inductance significantly depends on output ripple current. As shown by following equation, the ripple current decreases as the inductor and/or switching frequency increase.

$$\Delta I_L = \frac{(V_{IN} - V_{OUT}) \times V_{OUT}}{L \times V_{IN} \times f}$$

f: switching frequency    L: inductance     $\Delta I_L$ : inductor current ripple

As a minimum requirement, the DC current rating of the inductor should be equal to the maximum load current plus half of the inductor current ripple as shown by the following equation.

$$I_{LPEAK} = I_{OUTMAX} + \frac{\Delta I_L}{2}$$

1) Recommended inductor selection

- $I_{out} \leq 1.5A$   
DFE252012C Type 2.2uH (TOKO)  
NR4018T2R2M (TAIYO YUDEN)
- $I_{out} \leq 0.6A$   
NR3010T2R2M (TAIYO YUDEN)

2) Recommended input capacitor(CIN) selection

C1608 Type 22uF (X5R 6.3V TDK)

3)Recommended output capacitor(COUT) selection

C1608 Type 22uF (X5R 6.3V TDK)

**●Caution of use**

## 1) Absolute maximum ratings

An excess in the absolute maximum rating, such as supply voltage, temperature range of operating conditions, etc., can break down the devices, thus making impossible to identify breaking mode, such as a short circuit or an open circuit. If any over rated values will expect to exceed the absolute maximum ratings, consider adding circuit protection devices, such as fuses.

## 2) GND voltage

The potential of GND pin must be minimum potential in all condition. As an exception, the circuit design allows voltages up to -0.3 V to be applied to the IC pin.

## 3) Thermal design

Use a thermal design that allows for a sufficient margin in light of the power dissipation (Pd) in actual operating conditions.

## 4) Inter-pin shorts and mounting errors

Use caution when positioning the IC for mounting on printed circuit boards. The IC may be damaged if there is any connection error or if pins are shorted together.

## 5) Actions in strong electromagnetic field

Use caution when using the IC in the presence of a strong electromagnetic field as doing so may cause the IC to malfunction.

## 6) Mutual impedance

Power supply and ground wiring should reflect consideration of the need to lower mutual impedance and minimize ripple as much as possible (by making wiring as short and thick as possible or rejecting ripple by incorporating inductance and capacitance).

## 7) Thermal shutdown Circuit (TSD Circuit)

This model IC has a built-in TSD circuit. This circuit is only to cut off the IC from thermal runaway, and has not been design to protect or guarantee the IC. Therefore, the user should not plan to activate this circuit with continued operation in mind.

## 8) Regarding input pin of the IC

This monolithic IC contains P+ isolation and P substrate layers between adjacent elements in order to keep them isolated.

P-N junctions are formed at the intersection of these P layers with the N layers of other elements, creating a parasitic diode or transistor. For example, as shown in the figures below, the relation between each potential is as follows:

When  $GND > Pin A$  and  $GND > Pin B$ , the P-N junction operates as a parasitic diode.

When  $GND > Pin B$ , the P-N junction operates as a parasitic transistor.

Parasitic diodes can occur inevitable in the structure of the IC. The operation of parasitic diodes can result in mutual interference among circuits, operational faults, or physical damage. Accordingly, methods by which parasitic diodes operate, such as applying a voltage that is lower than the GND (P substrate) voltage to an input pin, should not be used.

**Status of this document**

The Japanese version of this document is formal specification. A customer may use this translation version only for a reference to help reading the formal version.

If there are any differences in translation version of this document formal version takes priority

●Ordering Information

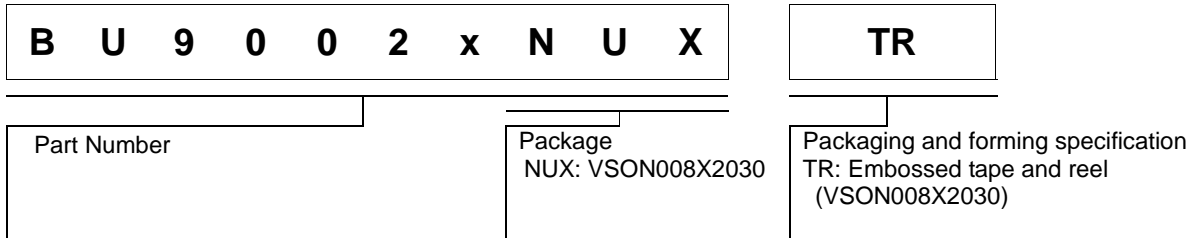

●Physical Dimension Tape and Reel Information

VSON008X2030

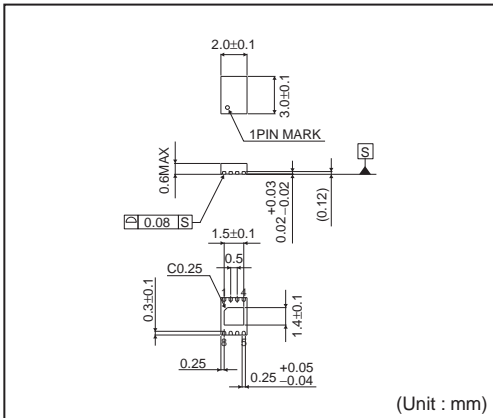

<Tape and Reel information>

|                   |  |
|-------------------|--|
| Tape              | Embossed carrier tape  |
| Quantity          | 4000pcs  |
| Direction of feed | TR<br>( The direction is the 1pin of product is at the upper right when you hold reel on the left hand and you pull out the tape on the right hand ) |

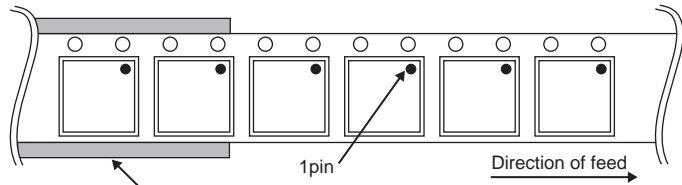

●Marking Diagram(s)(TOP VIEW)

VSON008X2030 (TOP VIEW)

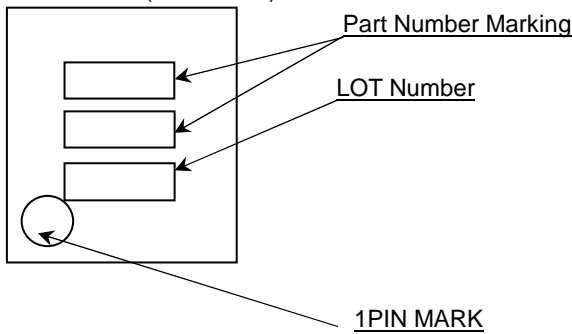

| Part No.   | Part Number Marking |
|------------|---------------------|
| BU90023NUX | U90                 |
|            | 023                 |
| BU90028NUX | U90                 |
|            | 028                 |

# Notice

## Precaution on using ROHM Products

- Our Products are designed and manufactured for application in ordinary electronic equipments (such as AV equipment, OA equipment, telecommunication equipment, home electronic appliances, amusement equipment, etc.). If you intend to use our Products in devices requiring extremely high reliability (such as medical equipment <sup>(Note 1)</sup>, transport equipment, traffic equipment, aircraft/spacecraft, nuclear power controllers, fuel controllers, car equipment including car accessories, safety devices, etc.) and whose malfunction or failure may cause loss of human life, bodily injury or serious damage to property ("Specific Applications"), please consult with the ROHM sales representative in advance. Unless otherwise agreed in writing by ROHM in advance, ROHM shall not be in any way responsible or liable for any damages, expenses or losses incurred by you or third parties arising from the use of any ROHM's Products for Specific Applications.

(Note1) Medical Equipment Classification of the Specific Applications

| JAPAN     | USA       | EU         | CHINA     |
|-----------|-----------|------------|-----------|
| CLASS III | CLASS III | CLASS II b | CLASS III |
| CLASS IV  |           | CLASS III  |           |

- ROHM designs and manufactures its Products subject to strict quality control system. However, semiconductor products can fail or malfunction at a certain rate. Please be sure to implement, at your own responsibilities, adequate safety measures including but not limited to fail-safe design against the physical injury, damage to any property, which a failure or malfunction of our Products may cause. The following are examples of safety measures:
  - Installation of protection circuits or other protective devices to improve system safety
  - Installation of redundant circuits to reduce the impact of single or multiple circuit failure
- Our Products are designed and manufactured for use under standard conditions and not under any special or extraordinary environments or conditions, as exemplified below. Accordingly, ROHM shall not be in any way responsible or liable for any damages, expenses or losses arising from the use of any ROHM's Products under any special or extraordinary environments or conditions. If you intend to use our Products under any special or extraordinary environments or conditions (as exemplified below), your independent verification and confirmation of product performance, reliability, etc. prior to use, must be necessary:
  - Use of our Products in any types of liquid, including water, oils, chemicals, and organic solvents
  - Use of our Products outdoors or in places where the Products are exposed to direct sunlight or dust
  - Use of our Products in places where the Products are exposed to sea wind or corrosive gases, including Cl<sub>2</sub>, H<sub>2</sub>S, NH<sub>3</sub>, SO<sub>2</sub>, and NO<sub>2</sub>
  - Use of our Products in places where the Products are exposed to static electricity or electromagnetic waves
  - Use of our Products in proximity to heat-producing components, plastic cords, or other flammable items
  - Sealing or coating our Products with resin or other coating materials
  - Use of our Products without cleaning residue of flux (even if you use no-clean type fluxes, cleaning residue of flux is recommended); or Washing our Products by using water or water-soluble cleaning agents for cleaning residue after soldering
  - Use of the Products in places subject to dew condensation
- The Products are not subject to radiation-proof design.
- Please verify and confirm characteristics of the final or mounted products in using the Products.
- In particular, if a transient load (a large amount of load applied in a short period of time, such as pulse. is applied, confirmation of performance characteristics after on-board mounting is strongly recommended. Avoid applying power exceeding normal rated power; exceeding the power rating under steady-state loading condition may negatively affect product performance and reliability.
- De-rate Power Dissipation (Pd) depending on Ambient temperature (Ta). When used in sealed area, confirm the actual ambient temperature.
- Confirm that operation temperature is within the specified range described in the product specification.
- ROHM shall not be in any way responsible or liable for failure induced under deviant condition from what is defined in this document.

## Precaution for Mounting / Circuit board design

- When a highly active halogenous (chlorine, bromine, etc.) flux is used, the residue of flux may negatively affect product performance and reliability.
- In principle, the reflow soldering method must be used; if flow soldering method is preferred, please consult with the ROHM representative in advance.

For details, please refer to ROHM Mounting specification

**Precautions Regarding Application Examples and External Circuits**

1. If change is made to the constant of an external circuit, please allow a sufficient margin considering variations of the characteristics of the Products and external components, including transient characteristics, as well as static characteristics.
2. You agree that application notes, reference designs, and associated data and information contained in this document are presented only as guidance for Products use. Therefore, in case you use such information, you are solely responsible for it and you must exercise your own independent verification and judgment in the use of such information contained in this document. ROHM shall not be in any way responsible or liable for any damages, expenses or losses incurred by you or third parties arising from the use of such information.

**Precaution for Electrostatic**

This Product is electrostatic sensitive product, which may be damaged due to electrostatic discharge. Please take proper caution in your manufacturing process and storage so that voltage exceeding the Products maximum rating will not be applied to Products. Please take special care under dry condition (e.g. Grounding of human body / equipment / solder iron, isolation from charged objects, setting of Ionizer, friction prevention and temperature / humidity control).

**Precaution for Storage / Transportation**

1. Product performance and soldered connections may deteriorate if the Products are stored in the places where:
  - [a] the Products are exposed to sea winds or corrosive gases, including Cl<sub>2</sub>, H<sub>2</sub>S, NH<sub>3</sub>, SO<sub>2</sub>, and NO<sub>2</sub>
  - [b] the temperature or humidity exceeds those recommended by ROHM
  - [c] the Products are exposed to direct sunshine or condensation
  - [d] the Products are exposed to high Electrostatic
2. Even under ROHM recommended storage condition, solderability of products out of recommended storage time period may be degraded. It is strongly recommended to confirm solderability before using Products of which storage time is exceeding the recommended storage time period.
3. Store / transport cartons in the correct direction, which is indicated on a carton with a symbol. Otherwise bent leads may occur due to excessive stress applied when dropping of a carton.
4. Use Products within the specified time after opening a humidity barrier bag. Baking is required before using Products of which storage time is exceeding the recommended storage time period.

**Precaution for Product Label**

QR code printed on ROHM Products label is for ROHM's internal use only.

**Precaution for Disposition**

When disposing Products please dispose them properly using an authorized industry waste company.

**Precaution for Foreign Exchange and Foreign Trade act**

Since our Products might fall under controlled goods prescribed by the applicable foreign exchange and foreign trade act, please consult with ROHM representative in case of export.

**Precaution Regarding Intellectual Property Rights**

1. All information and data including but not limited to application example contained in this document is for reference only. ROHM does not warrant that foregoing information or data will not infringe any intellectual property rights or any other rights of any third party regarding such information or data. ROHM shall not be in any way responsible or liable for infringement of any intellectual property rights or other damages arising from use of such information or data.:
2. No license, expressly or implied, is granted hereby under any intellectual property rights or other rights of ROHM or any third parties with respect to the information contained in this document.

**Other Precaution**

1. This document may not be reprinted or reproduced, in whole or in part, without prior written consent of ROHM.
2. The Products may not be disassembled, converted, modified, reproduced or otherwise changed without prior written consent of ROHM.
3. In no event shall you use in any way whatsoever the Products and the related technical information contained in the Products or this document for any military purposes, including but not limited to, the development of mass-destruction weapons.
4. The proper names of companies or products described in this document are trademarks or registered trademarks of ROHM, its affiliated companies or third parties.

**General Precaution**

1. Before you use our Products, you are requested to carefully read this document and fully understand its contents. ROHM shall not be in any way responsible or liable for failure, malfunction or accident arising from the use of any ROHM's Products against warning, caution or note contained in this document.
2. All information contained in this document is current as of the issuing date and subject to change without any prior notice. Before purchasing or using ROHM's Products, please confirm the latest information with a ROHM sales representative.
3. The information contained in this document is provided on an "as is" basis and ROHM does not warrant that all information contained in this document is accurate and/or error-free. ROHM shall not be in any way responsible or liable for any damages, expenses or losses incurred by you or third parties resulting from inaccuracy or errors of or concerning such information.