

Ambient Light Sensor IC Series

Digital 16bit Serial Output Type Ambient Light Sensor IC

BH1721FVC

No.11046ECT10

●Descriptions

BH1721FVC is an digital Ambient Light Sensor IC for I²C bus interface. This IC is the most suitable to obtain the ambient light data for adjusting LCD and Keypad backlight power of Mobile phone. It is possible to detect wide range at High resolution. (1 - 65528 lx).

●Features

- 1) I²C bus Interface (f / s Mode Support, Slave Address : "0100011")
- 2) Spectral responsibility is approximately human eye response
- 3) Illuminance to Digital Converter
- 4) Wide range and High resolution. (1 – 65528 lx)
- 5) Low Current by power down function
- 6) 50Hz / 60Hz Light noise reject-function
- 7) 1.8V Logic input interface
- 8) No need any external parts
- 9) Light source dependency is little. (ex. Incandescent Lamp. Fluorescent Lamp. Halogen Lamp. White LED. Sun Light)
- 10) Small measurement variation (+/- 15%)
- 11) Compact surface mount package 1.6 x 1.6 x 0.55 mm

●Applications

Mobile phone, LCD TV, NOTE PC, Portable game machine, Digital camera, Digital video camera, PDA, LCD display

●Absolute Maximum Ratings

Parameter	Symbol	Limits	Units
Supply Voltage	V _{max}	4.5	V
Operating Temperature	T _{opr}	-40~85	°C
Storage Temperature	T _{stg}	-40~100	°C
SDA Sink Current	I _{max}	7	mA
Power Dissipation	P _d	165*	mW

*70mm × 70mm × 1.6mm glass epoxy board. Derating is done at 2.2mW/°C for operating above Ta=25°C.

●Operating Conditions

Parameter	Symbol	Min.	Typ.	Max.	Units
VCC Voltage	V _{cc}	2.4	3.0	3.6	V
I ² C Reference Voltage	V _{DVI}	1.65	-	V _{cc}	V

●Electrical Characteristics (VCC = 3.0V, DVI = 3.0V, Ta = 25°C, unless otherwise noted)

Parameter	Symbol	Min.	Typ.	Max.	Units	Conditions
Supply Current	Icc1	—	140	199	μA	Ev = 100 lx ※1
Powerdown Current	Icc2	—	0.01	1.0	μA	No input Light
Peak Wave Length	λp	—	560	—	nm	
Measurement Accuracy	S/A	1.02	1.2	1.38	times	Sensor out / Actual lx ※1, ※2
Dark (0 lx) Sensor out	S0	0	0	2	count	H-Resolution Mode ※3
H-Resolution Mode Resolution	rHR	—	1	—	lx	
L-Resolution Mode Resolution	rLR	—	8	—	lx	
H-Resolution Mode Measurement Time	tHR	—	120	180	ms	
L-Resolution Mode Measurement Time	tLR	—	16	24	ms	
Incandescent / Fluorescent Sensor out ratio	rIF	—	1	—	times	EV = 1000 lx
DVI Input 'L' Voltage	VDVL	—	—	0.4	V	
SCL, SDA Input 'H' Voltage 1	VIH1	0.7 * DVI	—	—	V	DVI ≥ 1.8V
SCL, SDA Input 'H' Voltage 2	VIH2	1.26	—	—	V	1.65V ≤ DVI < 1.8V
SCL, SDA Input 'L' Voltage 1	VIL1	—	—	0.3 * DVI	V	DVI ≥ 1.8V
SCL, SDA Input 'L' Voltage 2	VIL2	—	—	DVI - 1.26	V	1.65V ≤ DVI < 1.8V
SCL, SDA, Input 'H' Current	IiH	—	—	10	μA	
SCL, SDA, Input 'L' Current	IiL	—	—	10	μA	
I ² C SCL Clock Frequency	fSCL	—	—	400	kHz	
I ² C Bus Free Time	tBUF	1.3	—	—	μs	
I ² C Hold Time (repeated) START Condition	tHDSTA	0.6	—	—	μs	
I ² C Set up time for a Repeated START Condition	tSUSTA	0.6	—	—	μs	
I ² C Set up time for a Repeated STOP Condition	tSUSTO	0.6	—	—	μs	
I ² C Data Hold Time	tHDDAT	0	—	—	μs	
I ² C Data Valid Time	tVDDAT	—	—	0.9	μs	
I ² C Data Valid Acknowledge Time	tVDACK	—	—	0.9	μs	
I ² C Data Setup Time	tSUDAT	100	—	—	ns	
I ² C 'L' Period of the SCL Clock	tLOW	1.3	—	—	μs	
I ² C 'H' Period of the SCL Clock	tHIGH	0.6	—	—	μs	
I ² C SDA Output 'L' Voltage	VOL	0	—	0.4	V	IOL = 3 mA

※1 White LED is used as optical source.

※2 Measurement Accuracy typical value is possible to change '1' by "Measurement result adjustment function".

※3 Use H-Resolution Mode if dark data (less than 20 lx) is need.

●Reference Data

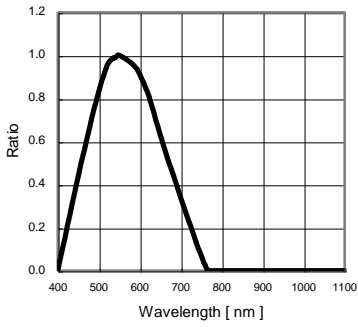

Fig.1 Spectral Response

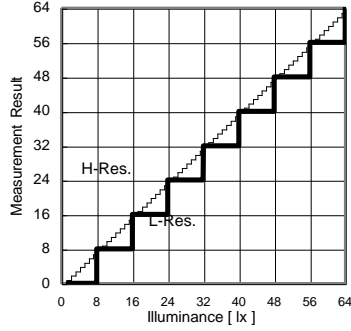

Fig.2 Illuminance - Measurement Result 1

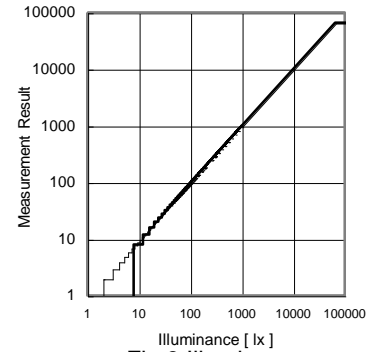

Fig.3 Illuminance - Measurement Result 2

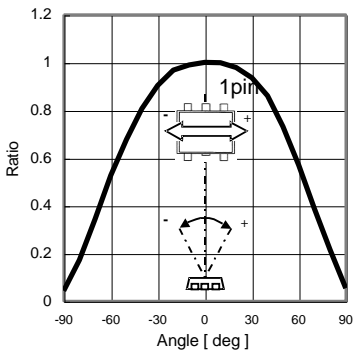

Fig.4 Directional Characteristics 1

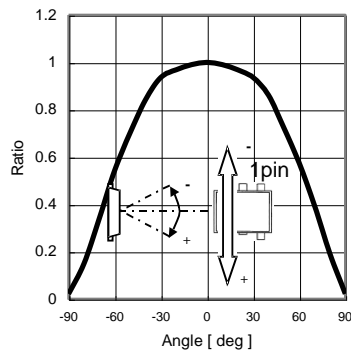

Fig.5 Directional Characteristics 2

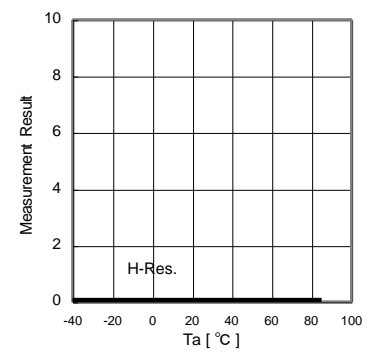

Fig.6 Dark Response

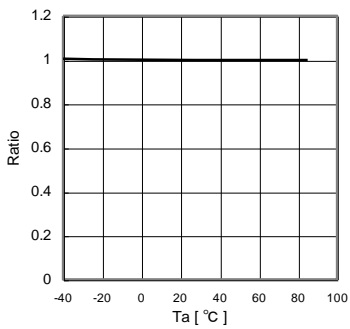

Fig.7 Measurement Result Temperature Dependency

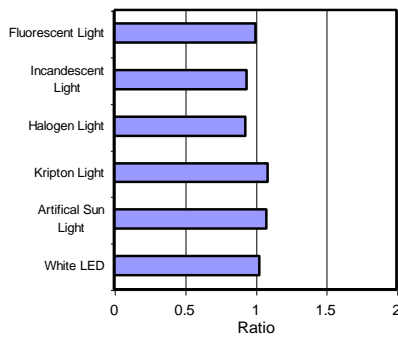

Fig.8 Light Source Dependency (Fluorescent Light is set to '1')

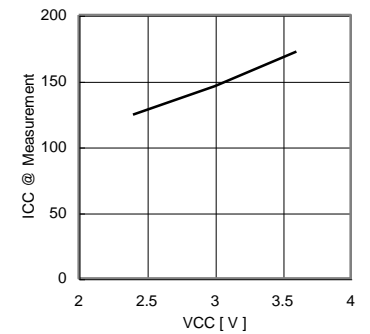

Fig.9 VCC - ICC (During measurement)

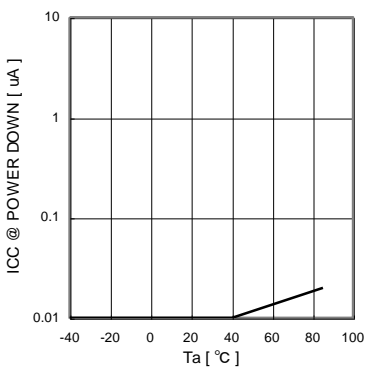

Fig.10 VCC - ICC@0 lx (POWER DOWN)

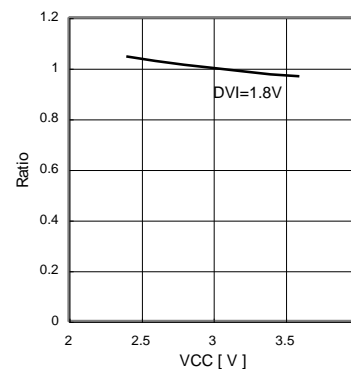

Fig.11 Measurement Result VCC Dependency

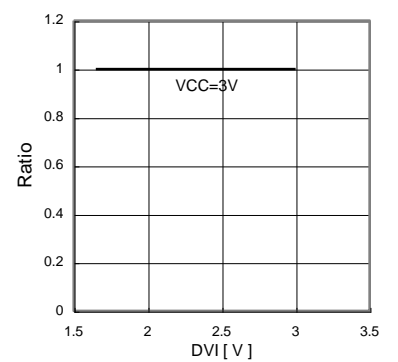
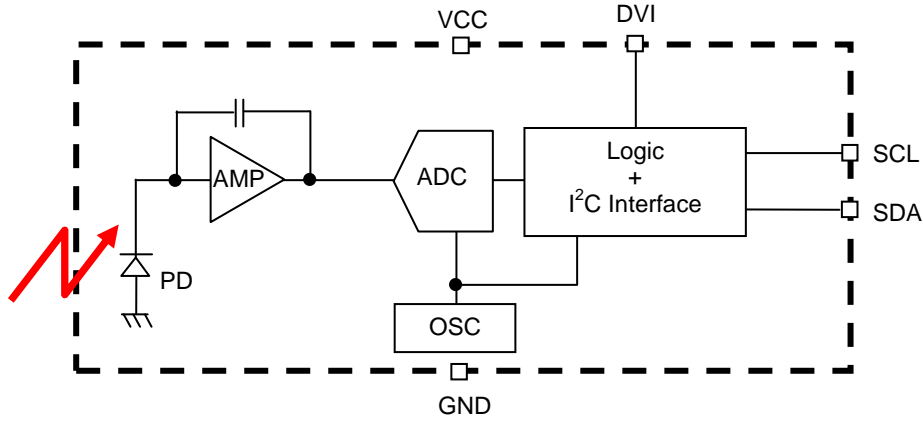

Fig.12 Measurement Result DVI Dependency

●Block Diagram



●Block Diagram Descriptions

- PD
Photo diode with approximately human eye response.
- AMP
Integration-OPAMP for converting from PD current to Voltage.
- ADC
AD converter for obtainment Digital 16bit data.
- Logic + I²C Interface
Ambient Light Calculation and I²C BUS Interface. It is including below register.
Data Register → This is for registration of Ambient Light Data. Initial Value is "0000_0000_0000_0000".
Measurement Time Register → This is for registration of measurement time. Initial Value is "01_0010_1100".
- OSC
Internal Oscillator. It is CLK for internal logic.

●Measurement Procedure

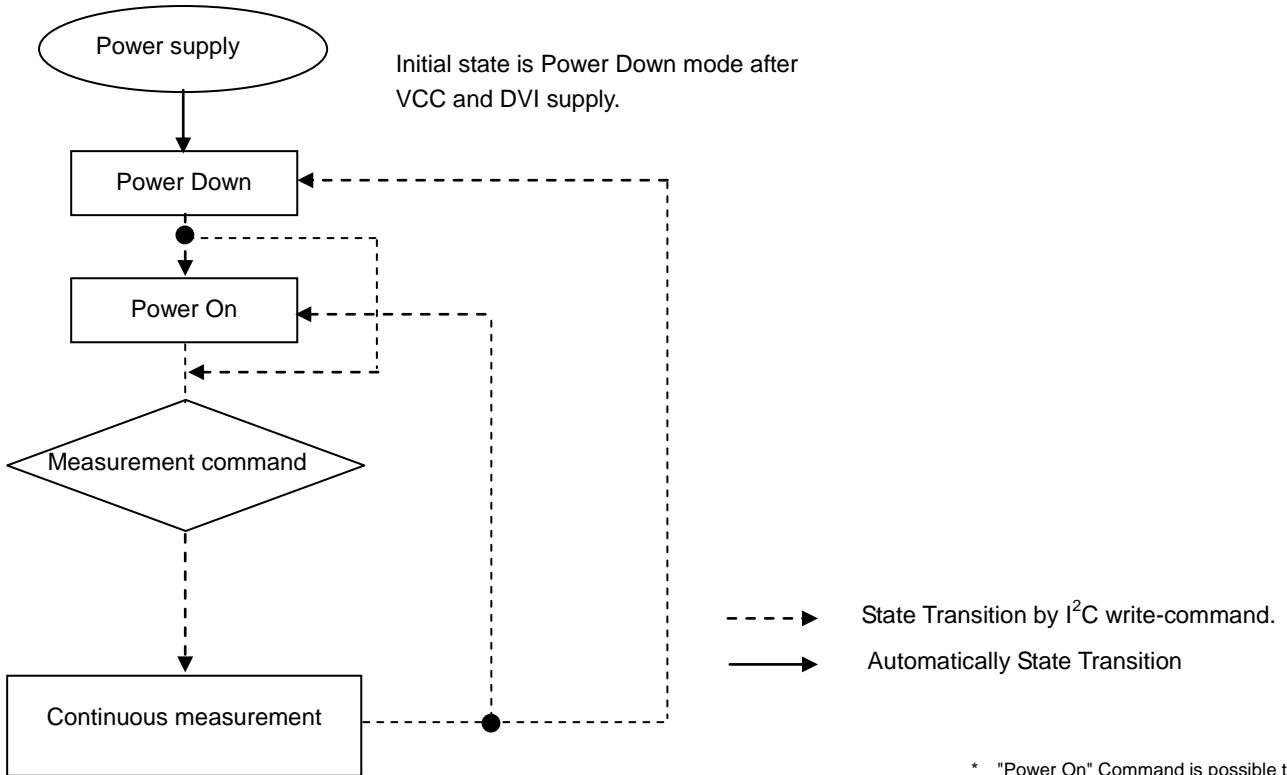

●Instruction Set Architecture

Instruction	Opecode	Comments
Power Down	0000_0000	No active state.
Power On	0000_0001	Waiting for measurement command.
Continuously Auto-Resolution Mode	0001_0000 0010_0000	Switch measurement mode automatically by illuminance.
Continuously H-Resolution Mode	0001_0010 0010_0010	Start measurement at 1lx resolution. Measurement Time is typically 120ms.
Continuously L-Resolution Mode	0001_0011 0001_0110 0010_0011 0010_0110	Start measurement at 8lx resolution. Measurement Time is typically 16ms.
Change Measurement time (High bit)	010_MT[9,8,7,6,5]	Change measurement time. ※ Please refer "adjust measurement result for influence of optical window."
Change Measurement time (Low bit)	011_MT[4]_XXXX	Change measurement time. ※ Please refer "adjust measurement result for influence of optical window."

※ Don't input the other opecode.

●Measurement mode explanation

Measurement Mode	Measurement Time.	Measurement Range.	Resolution
H-Resolution Mode	Typ. 120ms	0 - 8191 lx	1 lx
L-Resolution Mode	Typ. 16ms	0 - 65528 lx	8 lx

We recommend to use H-Resolution Mode.

Measurement time (integration time) of H-Resolution Mode is so long that some kind of noise (including in 50Hz / 60Hz noise) is rejected. And H-Resolution Mode is 1 lx resolution so that it is suitable for darkness (less than 20 lx)

Auto-Resolution mode selects measurement mode automatically. It is determined after 16ms (typ.) passes from measurement start. If BH1721FVC judges that current illuminance is more than 4000 lx, then Data is output at L-resolution mode, else Data is output after 120ms (typ.) from measurement start at H-resolution mode. Please refer below flow chart.

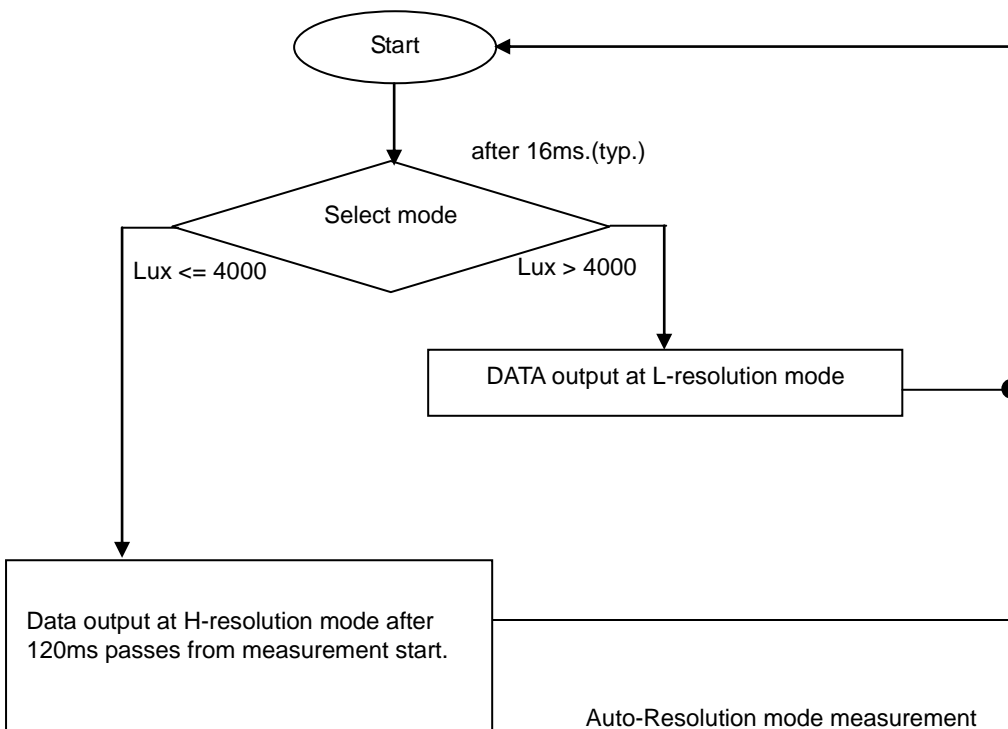

●Timing chart for VCC and DVI power supply sequence

DVI is I²C bus reference voltage terminal. And it is also asynchronous reset terminal. It is necessary to set to 'L' after VCC is supplied. In DVI 'L' term, internal state is set to Power Down mode.

1) Recommended Timing chart1 for VCC and DVI supply.



2) Timing chart2 for VCC and DVI supply.
(If DVI rises within 1µs after VCC supply)

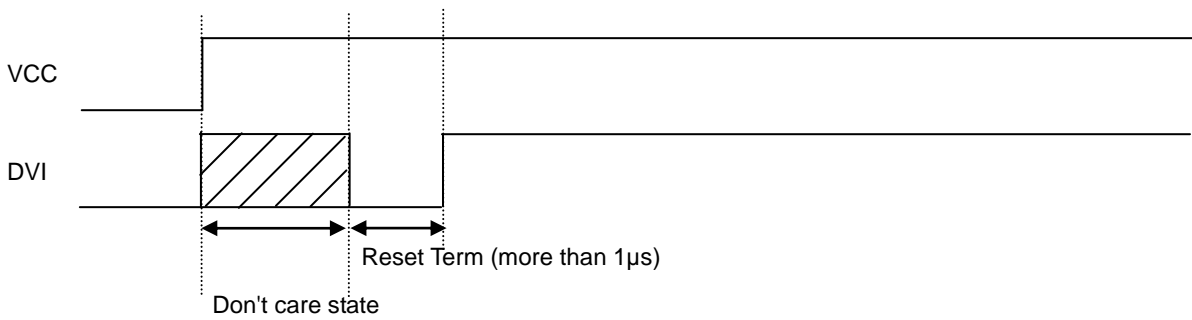

●Measurement sequence example from "Write instruction" to "Read measurement result"

ex1) Continuously Auto-resolution mode



① Send "Continuously Auto-resolution mode " instruction

ST	0100011	0	Ack	00010000	Ack	SP
----	---------	---	-----	----------	-----	----

② Wait to complete 1st Auto-resolution mode measurement.(max. 180ms)

③ Read measurement result.

ST	0100011	1	Ack	High Byte [15:8]	Ack
----	---------	---	-----	--------------------	-----

Low Byte [7:0]	Ack	SP
------------------	-----	----

How to calculate when the data High Byte is "10000011" and Low Byte is "10010000"
 $(2^{15} + 2^9 + 2^8 + 2^7 + 2^4) / 1.2 \doteq 28067 [lx]$

The result of continuously measurement mode is updated.

ex2) Continuously L-resolution mode

① Send " Continuously L-resolution mode " instruction

ST	0100011	0	Ack	00010011	Ack	SP
----	---------	---	-----	----------	-----	----

② Wait to complete L-resolution mode measurement.(max. 24ms)

③ Read measurement result

ST	0100011	1	Ack	High Byte [15:8]	Ack
----	---------	---	-----	--------------------	-----

Low Byte [7:0]	Ack	SP
------------------	-----	----

How to calculate when the data High Byte is "00000001" and Low Byte is "00010000"
 $(2^8 + 2^4) / 1.2 \doteq 227 [lx]$

●Application circuit example of DVI terminal

The DVI terminal is an asynchronous reset terminal. Please note that there is a possibility that IC doesn't operate normally if the reset section is not installed after the start-up of VCC.

(Please refer to the paragraph of "Timing chart for VCC and DVI power supply sequence")

The description concerning SDA and the terminal SCL is omitted in this application circuit example. Please design the application the standard of the I²C bus as it finishes being satisfactory.

ex 1) The control signal line such as CPU is connected.

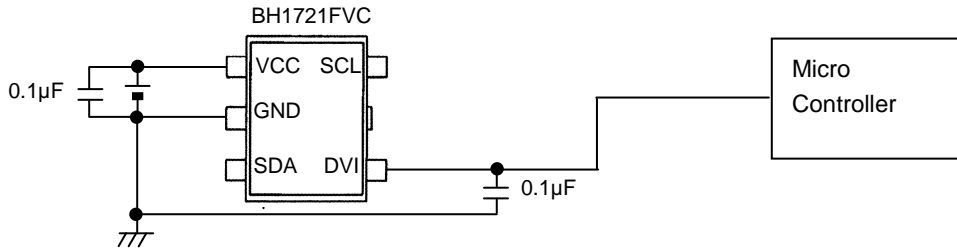

ex 2) Reset IC is used.

1, For Reset IC of the Push-Pull type

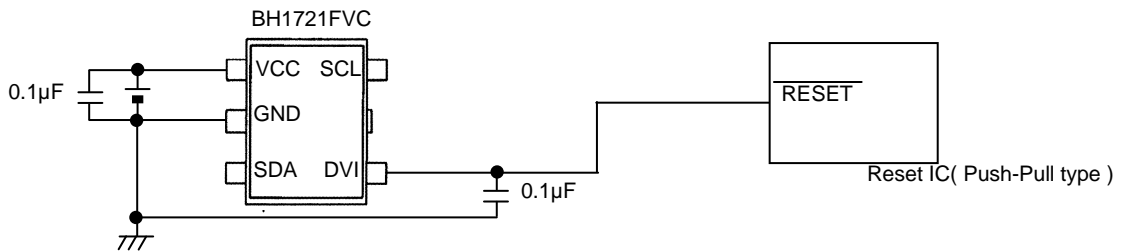

2, For Reset IC of the Open drain output

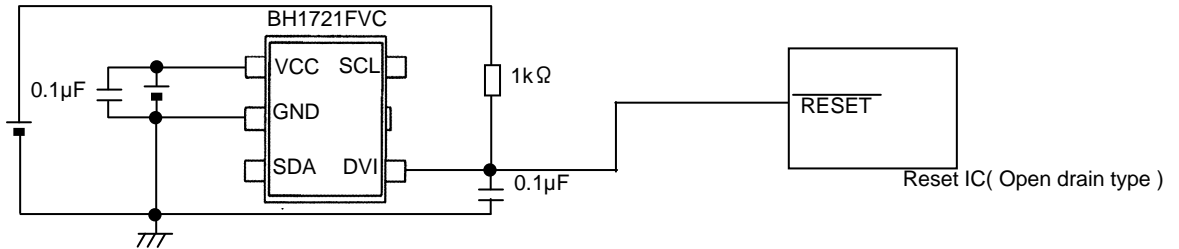

ex 3) A different power supply is used.

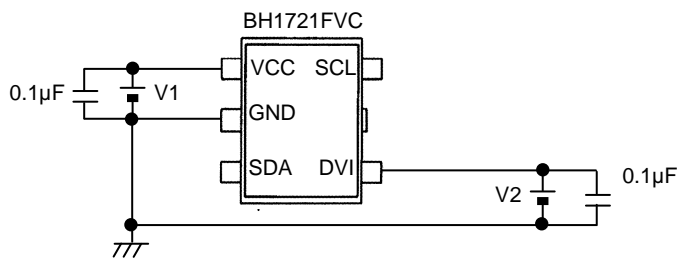

※ Power supply of DVI must stand up later than power supply of VCC stand up, because it is necessary to secure reset section (1µs or more).

ex 4) LPF using CR is inserted between VCC and DVI.

This method has the possibility that the Reset section of turning on the power supply can not satisfied. Cannot be satisfied. Please design the set considering the characteristic of the power supply enough.

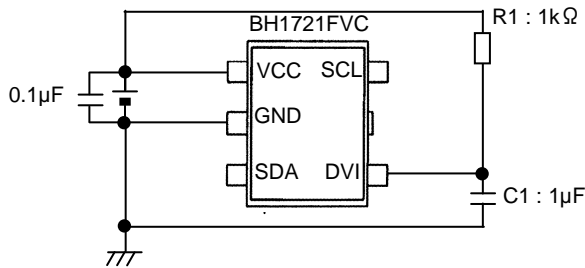

◆ Notes when CR is inserted between VCC and DVI

- ※Please note that there is a possibility that reset section (1µs) can not be satisfied because the power supply is turned on when the rise time of VCC is slow
- ※When VCC is turned off, the DVI voltage becomes higher than VCC voltage but IC destruction is not ocurred if recommended constant (R1 = 1kΩ , C1 = 1µF) is used.
- ※Please note that there is a possibility that Reset section (1µsec) cannot be satisfied if wait time is not enough long after turning off VCC. (It is necessary to consider DVI voltage level after turning off VCC.)

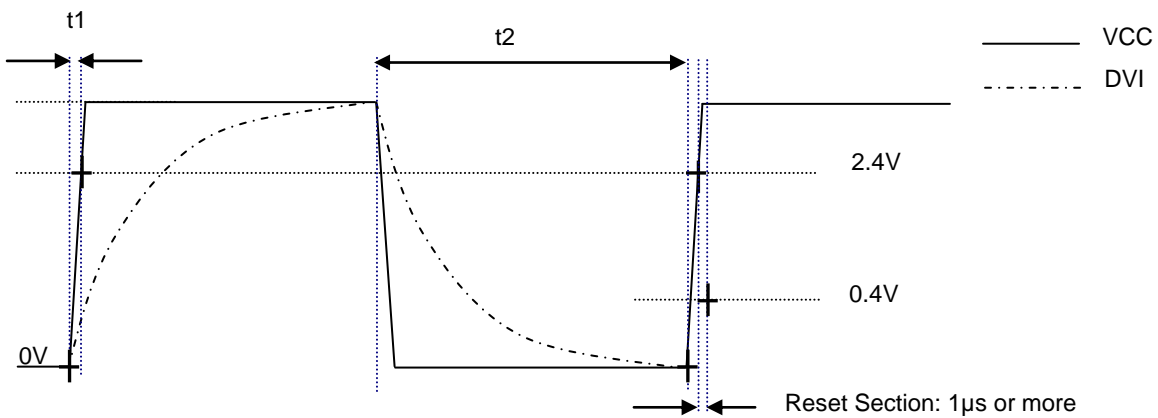

* Please do the application design to secure Reset section 1µs or more after the reclosing of the power supply.

◆ Example of designing set when CR (C = 1µF, R = 1kΩ) is inserted between VCC and DVI with VCC=2.8V

- ①The rise time to 0→2.4V of VCC must use the power supply of 100µs or less.
- ②Please wait 25ms or more after VCC turn off (VCC <= 0.05V), because it is necessary to secure reset section (1µs or more).

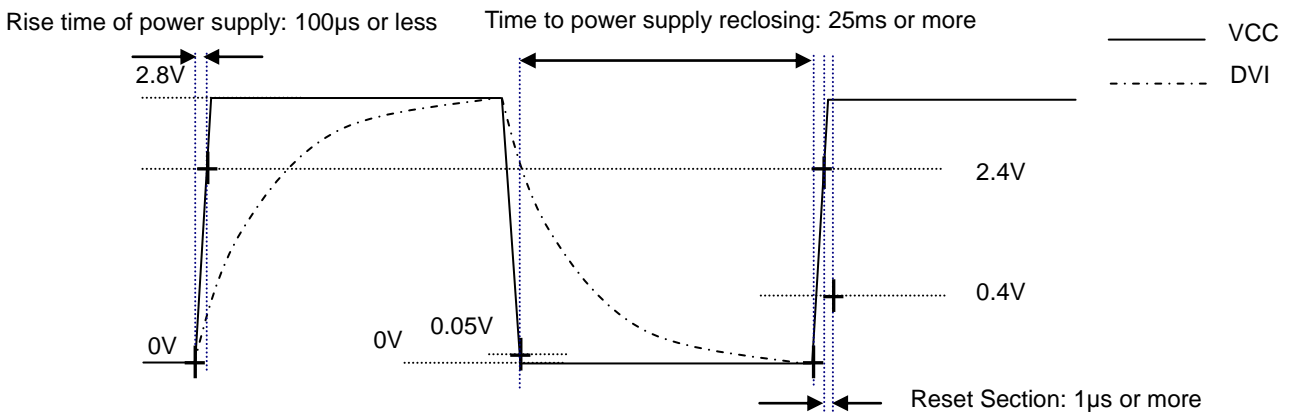

* Please do the application design to secure Reset section 1µs or more after the reclosing of the power supply.

● I²C Bus Access

1) I²C Bus Interface Timing chart

Write measurement command and Read measurement result are done by I²C Bus interface. Please refer the formally specification of I²C Bus interface, and follow the formally timing chart.

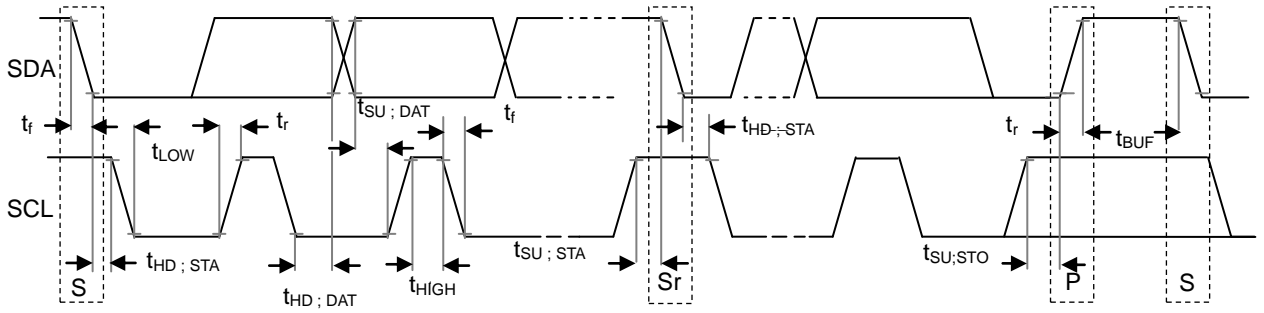

2) Write Format

BH1721FVC is not able to accept plural command without stop condition. Please insert SP every 1 Opcode.

ST	Slave Address "0100011"	R/W 0	Ack	Opcode	Ack	SP
----	----------------------------	----------	-----	--------	-----	----

3) Read Format

ST	Slave Address "0100011"	R/W 1	Ack	High Byte [15:8] $2^{15} 2^{14} 2^{13} 2^{12} 2^{11} 2^{10} 2^9 2^8$	Ack
----	----------------------------	----------	-----	---	-----

$2^7 2^6 2^5 2^4 2^3 2^2 2^1 2^0$	Low Byte [7:0]	$\overline{\text{Ack}}$	SP
-----------------------------------	----------------	-------------------------	----



from Master to Slave



from Slave to Master

ex)

High Byte = "1000_0011"

Low Byte = "1001_0000"

$$(2^{15} + 2^9 + 2^8 + 2^7 + 2^4) / 1.2 \doteq 28067 [lx]$$

* Please refer formality I²C bus specification of NXP semiconductors.

●Adjust measurement result for influence of optical window. (sensor sensitivity adjusting)

BH1721FVC is possible to change sensor sensitivity. And it is possible to cancel the optical window influence (difference with / without optical window) by using this function. Adjust is done by changing measurement time. For example, when transmission rate of optical window is 50% (measurement result becomes 0.5 times if optical window is set), influence of optical window is ignored by changing sensor sensitivity from default to 2 times

Sensor sensitivity is shift by changing the value of MTreg (measurement time register). MTreg value has to set 2 times if target of sensor sensitivity is 2 times. Measurement time is also set 2 times when MTreg value is changed from default to 2 times. Low 4bit value is fixed"1100". Please change high 6bit value of this register via to I²C Bus interface.

ex) Procedure for changing target sensor sensitivity to 2 times.

Please change Mtreg from"01_0010_1100" (default) to"10_0101_1100" (default * 2).

1) Changing High bit of Mtreg

ST	Slave Address	R/W 0	Ack	010_10010	Ack	SP
----	---------------	----------	-----	-----------	-----	----

2) Changing Low bit of Mtreg

ST	Slave Address	R/W 0	Ack	011_1XXXX	Ack	SP
----	---------------	----------	-----	-----------	-----	----

* X value is ignore.

3) Input Measurement Command.

ST	Slave Address	R/W 0	Ack	0001_0000	Ack	SP
----	---------------	----------	-----	-----------	-----	----

* This example is High Resolution mode, but it accepts the other measurement.

4) After about 240ms, measurement result is registered to Data Register. (High Resolution mode is typically 120ms, but measurement time is set twice.)

The below table is seeing the changeable range of MTreg.

		Min.	Typ.	Max.
changeable range of MTreg	binary	00_1000_1100 (sensitivity : default * 0.47)	01_0010_1100 default	11_1111_1100 (sensitivity : default * 3.40)
	decimal	140 (sensitivity : default * 0.47)	300 default	1020 (sensitivity : default * 3.40)

It is possible to detect 0.25lx by using this function at H-resolution mode. The below formula is to calculate illuminance per 1 count.

$$\text{Illuminance per 1 count (lx / count)} = 1 / 1.2 * (300 / X)$$

1.2 : Measurement accuracy
300 : Default value of MTreg (dec)
X : MTreg value

The below table is seeing the detail of resolution.

MTreg value	lx / count
00_1000_1100	1.79
01_0010_1100	0.83
11_1111_1100	0.25

Please input the opcode at PowerDown state to change Mtreg. There is a possibility of malfunctioning when the opcode to change Mtreg is input while the illuminance measurement is going .

●Terminal Description

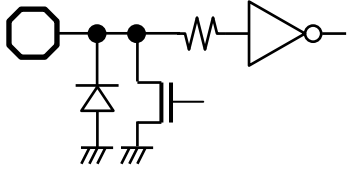
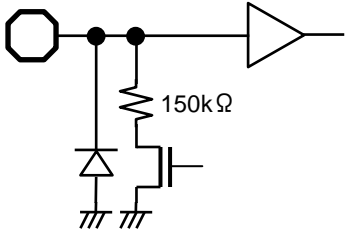
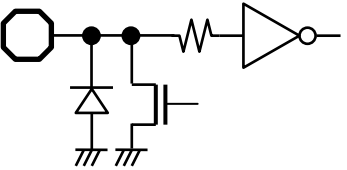
PIN No.	Terminal Name	Equivalent Circuit	Function
1	VCC		Power Supply Terminal
2	GND		GND Terminal
3	SDA		I ² C bus Interface SDA Terminal
4	DVI		SDA, SCL Reference Voltage Terminal And DVI Terminal is also asynchronous Reset for internal registers. So that please set to 'L' (at least 1μs, DVI <= 0.4V) after VCC is supplied. BH1721FVC is pulled down by 150kΩ while DVI = 'L'.
5	SCL		I ² C bus Interface SCL Terminal

※These values are design-value, not guaranteed.

●Package Outlines

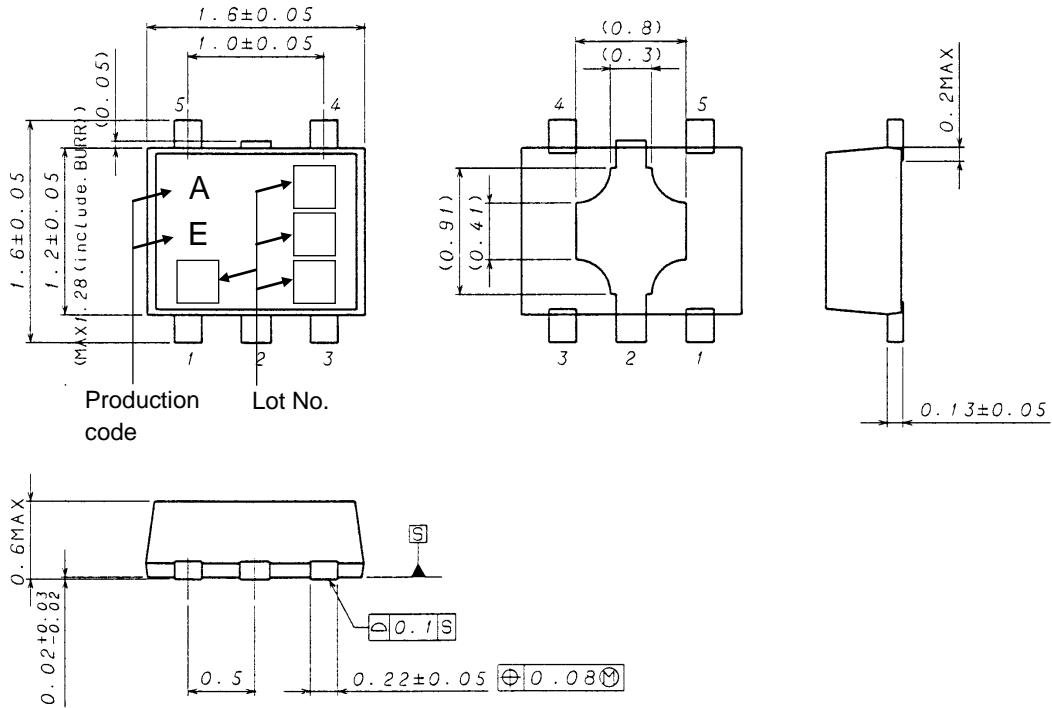

WSOF5 (Unit: mm)

●Optical design for the device

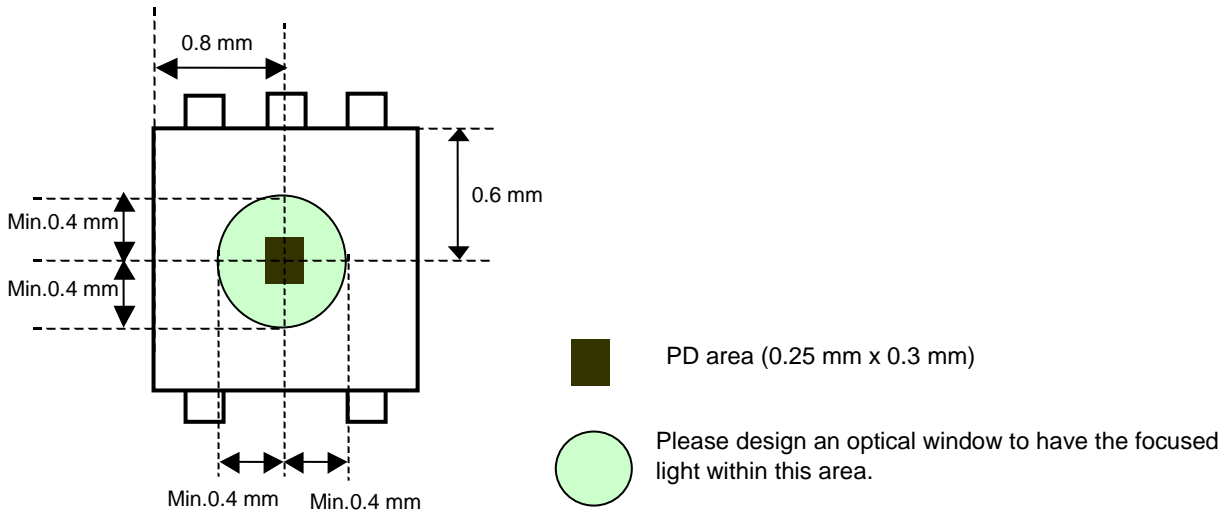

●Notes for use

- 1) Absolute Maximum Ratings
An excess in the absolute maximum ratings, such as supply voltage (V_{max}), temperature range of operating conditions (T_{opr}), etc., can break down devices, thus making impossible to identify breaking mode such as a short circuit or an open circuit. If any special mode exceeding the absolute maximum ratings is assumed, consideration should be given to take physical safety measures including the use of fuses, etc.
- 2) GND voltage
Make setting of the potential of the GND terminal so that it will be maintained at the minimum in any operating state. Furthermore, check to be sure no terminals are at a potential lower than the GND voltage including an actual electric transient.
- 3) Short circuit between terminals and erroneous mounting
In order to mount ICs on a set PCB, pay thorough attention to the direction and offset of the ICs. Erroneous mounting can break down the ICs. Furthermore, if a short circuit occurs due to foreign matters entering between terminals or between the terminal and the power supply or the GND terminal, the ICs can break down.
- 4) Operation in strong electromagnetic field
Be noted that using ICs in the strong electromagnetic field can malfunction them.
- 5) Inspection with set PCB
On the inspection with the set PCB, if a capacitor is connected to a low-impedance IC terminal, the IC can suffer stress. Therefore, be sure to discharge from the set PCB by each process. Furthermore, in order to mount or dismount the set PCB to/from the jig for the inspection process, be sure to turn OFF the power supply and then mount the set PCB to the jig. After the completion of the inspection, be sure to turn OFF the power supply and then dismount it from the jig. In addition, for protection against static electricity, establish a ground for the assembly process and pay thorough attention to the transportation and the storage of the set PCB.
- 6) Input terminals
In terms of the construction of IC, parasitic elements are inevitably formed in relation to potential. The operation of the parasitic element can cause interference with circuit operation, thus resulting in a malfunction and then breakdown of the input terminal. Therefore, pay thorough attention not to handle the input terminals; such as to apply to the input terminals a voltage lower than the GND respectively, so that any parasitic element will operate. Furthermore, do not apply a voltage to the input terminals when no power supply voltage is applied to the IC. In addition, even if the power supply voltage is applied, apply to the input terminals a voltage lower than the power supply voltage or within the guaranteed value of electrical characteristics.
- 7) Thermal design
Perform thermal design in which there are adequate margins by taking into account the power dissipation (P_d) in actual states of use.
- 8) Treatment of package
Dusts or scratch on the photo detector may affect the optical characteristics. Please handle it with care.
- 9) Rush current
When power is first supplied to the CMOS IC, it is possible that the internal logic may be unstable and rush current may flow instantaneously. Therefore, give special consideration to power coupling capacitance, power wiring, width of GND wiring, and routing of connections.
- 10) The exposed central pad on the back side of the package
There is an exposed central pad on the back side of the package. Please mount product by Footprint dimensions described in the Jisso Information for WSO5F5. This pad is GND level, therefore there is a possibility that LSI malfunctions and heavy-current is generated, if it's connected to other pin.

● Ordering part number

B	H
---	---

Part No.

1	7	2	1
---	---	---	---

Part No.

F	V	C
---	---	---

Package
FVC: WSOF5

T	R
---	---

Packaging and forming specification
TR: Embossed tape and reel

WSOF5

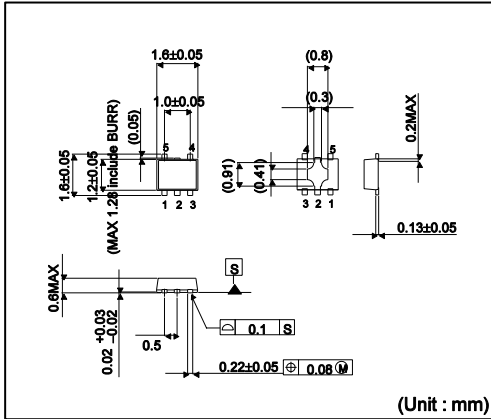

<Tape and Reel information>

Tape	Embossed carrier tape
Quantity	3000pcs
Direction of feed	TR (The direction is the 1pin of product is at the upper right when you hold reel on the left hand and you pull out the tape on the right hand)

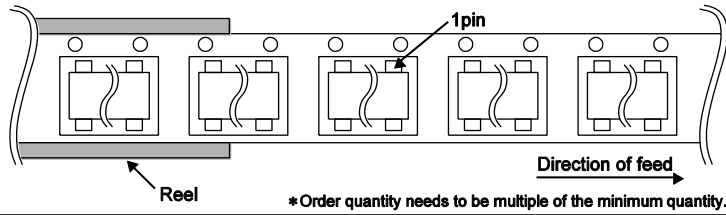

Notice

Precaution on using ROHM Products

- Our Products are designed and manufactured for application in ordinary electronic equipment (such as AV equipment, OA equipment, telecommunication equipment, home electronic appliances, amusement equipment, etc.). If you intend to use our Products in devices requiring extremely high reliability (such as medical equipment ^(Note 1), transport equipment, traffic equipment, aircraft/spacecraft, nuclear power controllers, fuel controllers, car equipment including car accessories, safety devices, etc.) and whose malfunction or failure may cause loss of human life, bodily injury or serious damage to property ("Specific Applications"), please consult with the ROHM sales representative in advance. Unless otherwise agreed in writing by ROHM in advance, ROHM shall not be in any way responsible or liable for any damages, expenses or losses incurred by you or third parties arising from the use of any ROHM's Products for Specific Applications.

(Note1) Medical Equipment Classification of the Specific Applications

JAPAN	USA	EU	CHINA
CLASS III	CLASS III	CLASS II b	CLASS III
CLASS IV		CLASS III	

- ROHM designs and manufactures its Products subject to strict quality control system. However, semiconductor products can fail or malfunction at a certain rate. Please be sure to implement, at your own responsibilities, adequate safety measures including but not limited to fail-safe design against the physical injury, damage to any property, which a failure or malfunction of our Products may cause. The following are examples of safety measures:
 - Installation of protection circuits or other protective devices to improve system safety
 - Installation of redundant circuits to reduce the impact of single or multiple circuit failure
- Our Products are designed and manufactured for use under standard conditions and not under any special or extraordinary environments or conditions, as exemplified below. Accordingly, ROHM shall not be in any way responsible or liable for any damages, expenses or losses arising from the use of any ROHM's Products under any special or extraordinary environments or conditions. If you intend to use our Products under any special or extraordinary environments or conditions (as exemplified below), your independent verification and confirmation of product performance, reliability, etc. prior to use, must be necessary:
 - Use of our Products in any types of liquid, including water, oils, chemicals, and organic solvents
 - Use of our Products outdoors or in places where the Products are exposed to direct sunlight or dust
 - Use of our Products in places where the Products are exposed to sea wind or corrosive gases, including Cl₂, H₂S, NH₃, SO₂, and NO₂
 - Use of our Products in places where the Products are exposed to static electricity or electromagnetic waves
 - Use of our Products in proximity to heat-producing components, plastic cords, or other flammable items
 - Sealing or coating our Products with resin or other coating materials
 - Use of our Products without cleaning residue of flux (Exclude cases where no-clean type fluxes is used. However, recommend sufficiently about the residue.) ; or Washing our Products by using water or water-soluble cleaning agents for cleaning residue after soldering
 - Use of the Products in places subject to dew condensation
- The Products are not subject to radiation-proof design.
- Please verify and confirm characteristics of the final or mounted products in using the Products.
- In particular, if a transient load (a large amount of load applied in a short period of time, such as pulse, is applied, confirmation of performance characteristics after on-board mounting is strongly recommended. Avoid applying power exceeding normal rated power; exceeding the power rating under steady-state loading condition may negatively affect product performance and reliability.
- De-rate Power Dissipation depending on ambient temperature. When used in sealed area, confirm that it is the use in the range that does not exceed the maximum junction temperature.
- Confirm that operation temperature is within the specified range described in the product specification.
- ROHM shall not be in any way responsible or liable for failure induced under deviant condition from what is defined in this document.

Precaution for Mounting / Circuit board design

- When a highly active halogenous (chlorine, bromine, etc.) flux is used, the residue of flux may negatively affect product performance and reliability.
- In principle, the reflow soldering method must be used on a surface-mount products, the flow soldering method must be used on a through hole mount products. If the flow soldering method is preferred on a surface-mount products, please consult with the ROHM representative in advance.

For details, please refer to ROHM Mounting specification

Precautions Regarding Application Examples and External Circuits

1. If change is made to the constant of an external circuit, please allow a sufficient margin considering variations of the characteristics of the Products and external components, including transient characteristics, as well as static characteristics.
2. You agree that application notes, reference designs, and associated data and information contained in this document are presented only as guidance for Products use. Therefore, in case you use such information, you are solely responsible for it and you must exercise your own independent verification and judgment in the use of such information contained in this document. ROHM shall not be in any way responsible or liable for any damages, expenses or losses incurred by you or third parties arising from the use of such information.

Precaution for Electrostatic

This Product is electrostatic sensitive product, which may be damaged due to electrostatic discharge. Please take proper caution in your manufacturing process and storage so that voltage exceeding the Products maximum rating will not be applied to Products. Please take special care under dry condition (e.g. Grounding of human body / equipment / solder iron, isolation from charged objects, setting of Ionizer, friction prevention and temperature / humidity control).

Precaution for Storage / Transportation

1. Product performance and soldered connections may deteriorate if the Products are stored in the places where:
 - [a] the Products are exposed to sea winds or corrosive gases, including Cl₂, H₂S, NH₃, SO₂, and NO₂
 - [b] the temperature or humidity exceeds those recommended by ROHM
 - [c] the Products are exposed to direct sunshine or condensation
 - [d] the Products are exposed to high Electrostatic
2. Even under ROHM recommended storage condition, solderability of products out of recommended storage time period may be degraded. It is strongly recommended to confirm solderability before using Products of which storage time is exceeding the recommended storage time period.
3. Store / transport cartons in the correct direction, which is indicated on a carton with a symbol. Otherwise bent leads may occur due to excessive stress applied when dropping of a carton.
4. Use Products within the specified time after opening a humidity barrier bag. Baking is required before using Products of which storage time is exceeding the recommended storage time period.

Precaution for Product Label

A two-dimensional barcode printed on ROHM Products label is for ROHM's internal use only.

Precaution for Disposition

When disposing Products please dispose them properly using an authorized industry waste company.

Precaution for Foreign Exchange and Foreign Trade act

Since concerned goods are fallen under listed items of export control prescribed by Foreign exchange and Foreign trade act, the permission based on the act is necessary in case of export.

Precaution Regarding Intellectual Property Rights

1. All information and data including but not limited to application example contained in this document is for reference only. ROHM does not warrant that foregoing information or data will not infringe any intellectual property rights or any other rights of any third party regarding such information or data.
2. ROHM shall not have any obligations where the claims, actions or demands arising from the combination of the Products with other articles such as components, circuits, systems or external equipment (including software).
3. No license, expressly or implied, is granted hereby under any intellectual property rights or other rights of ROHM or any third parties with respect to the Products or the information contained in this document. Provided, however, that ROHM will not assert its intellectual property rights or other rights against you or your customers to the extent necessary to manufacture or sell products containing the Products, subject to the terms and conditions herein.

Other Precaution

1. This document may not be reprinted or reproduced, in whole or in part, without prior written consent of ROHM.
2. The Products may not be disassembled, converted, modified, reproduced or otherwise changed without prior written consent of ROHM.
3. In no event shall you use in any way whatsoever the Products and the related technical information contained in the Products or this document for any military purposes, including but not limited to, the development of mass-destruction weapons.
4. The proper names of companies or products described in this document are trademarks or registered trademarks of ROHM, its affiliated companies or third parties.

一般的な注意事項

1. 本製品をご使用になる前に、本資料をよく読み、その内容を十分に理解されるようお願い致します。本資料に記載される注意事項に反して本製品をご使用されたことによって生じた不具合、故障及び事故に関し、ロームは一切その責任を負いませんのでご注意願います。
2. 本資料に記載の内容は、本資料発行時点のものであり、予告なく変更することがあります。本製品のご購入及びご使用に際しては、事前にローム営業窓口で最新の情報をご確認ください。
3. ロームは本資料に記載されている情報は誤りがないことを保証するものではありません。万が一、本資料に記載された情報の誤りによりお客様又は第三者に損害が生じた場合においても、ロームは一切その責任を負いません。