



940nm Infrared VCSEL

RLD94SAQ8 Series

Datasheet

- Application
 - 3D Depth Sensor
 - TOF Sensor
 - IR Illumination
 - Etc.

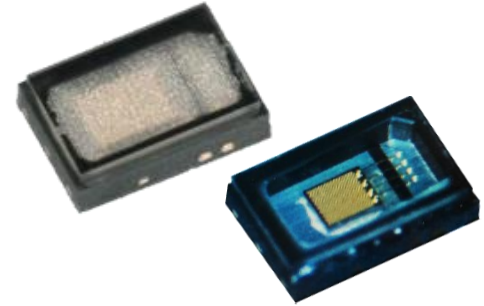

- Merit
 - Optical output power 2W
 - MSL3 250°C peak reflow compatible
 - Thin Package t0.97mm(Diffuser type) , t0.77mm(Clear glass type)

• Absolute Maximum Ratings

Parameter	Symbol	Ratings	Unit
Continuous Forward Current	If (CW)	incompatible	A
Pulse Forward Current 100Hz Duty1% (on time 100μs)	If (Pulse)	10	A (Tc = 25°C)
Reverse Voltage	Vr	5	V (Tc = 25°C)
Junction temp.	Tj	110	°C
Solder reflow temp.	Tsr	250(10sec)	°C
Operating temp.	Top	-20 to 70	°C
Storage temp.	Tstg	-40 to 85	°C

Condition : mounted on AL board with Heatsink

• Characteristics (Ta=25°C)

Parameter	Symbol	Conditions	MIN.	TYP.	MAX.	Unit
Threshold current	Ith	–	–	750	–	mA
Optical Power	Po	If=3A (tp=400μsec.)	1.4	2.0	–	W
Forward voltage	Vf	If=3A (tp=400μsec.)	–	2.0	2.5	V
Conversion efficiency	PCE	-	–	40	–	%
Slope efficiency	η	-	–	1.0	–	W/A
Peak Wavelength	λp	If=3A (tp=400μsec.)	930	940	950	nm
λ temp variation	Δλ/ΔT	-	–	0.07	–	nm/°C
ESD damage threshold	ESD HBM	Human Body Model	2000	–	–	V
Far Field Pattern	FFP	*please see page 4.				

Caution : The data above is used as reference only, i.e. not specification guarantee. Specifications and data are subject to change without notice.

●Dimensions

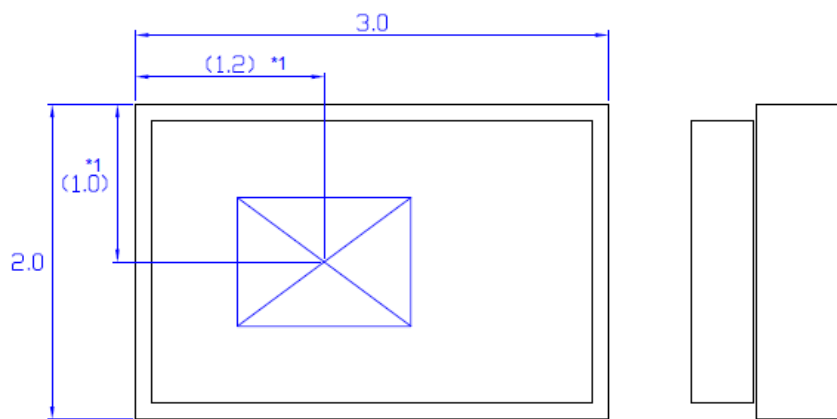

*1 : Light Source Center

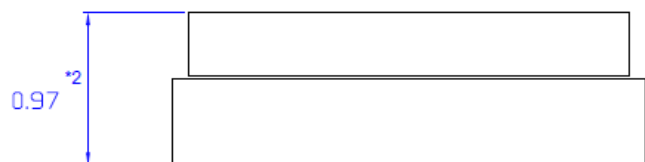

*2 : The height of the clear glass type is t0.77mm

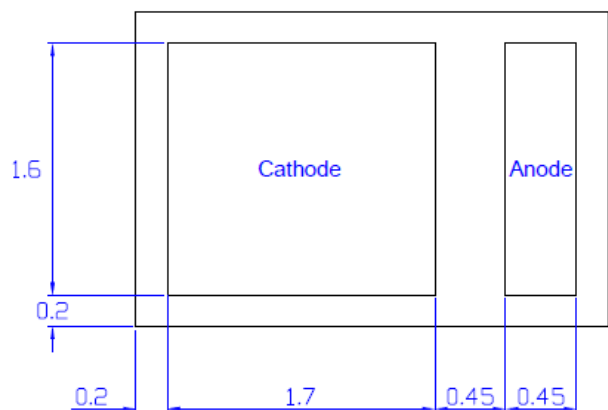

Unit : mm



Note

- Unspecified tolerance shall be $\pm 0.15\text{mm}$
- Dimensions do not include burrs
(Max burr size +0.25mm)

●Typical Electro-Optical Characteristics

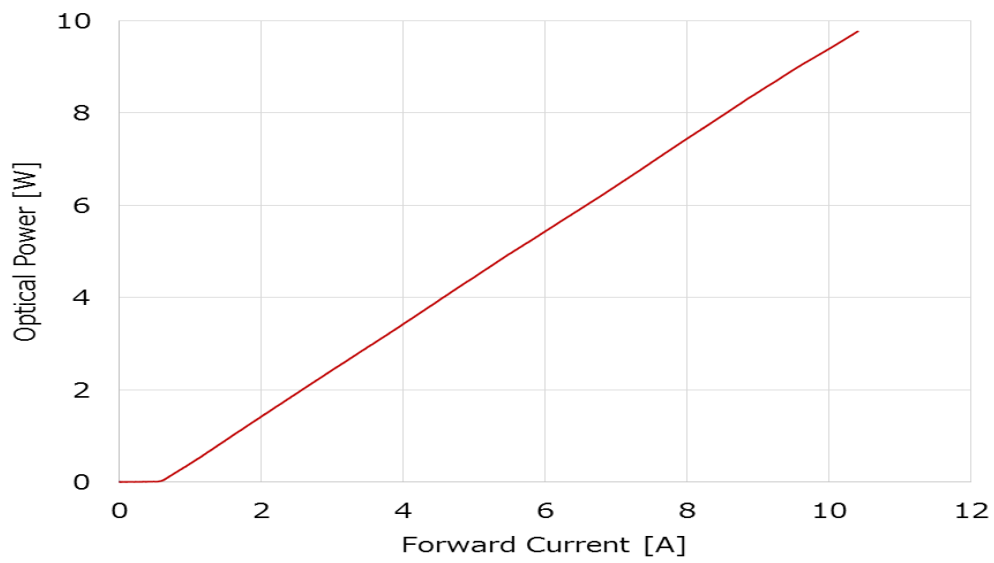

Condition : Pulse 100kHz Duty1% (on time 100nsec.) , Ta=25°C with Heatsink

●Far Field Pattern (Diffuser Type)

• 60×45deg Diffuser

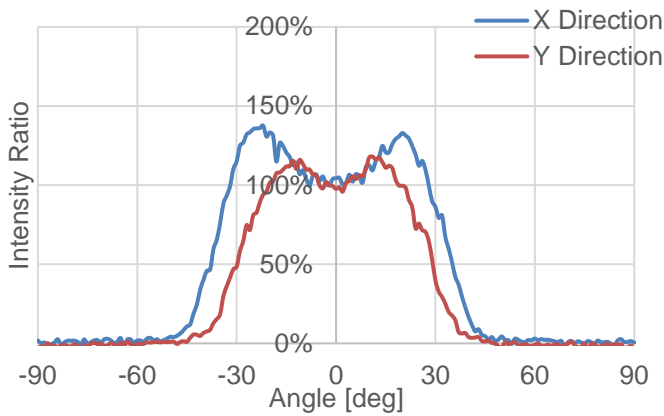

• 72×55deg Diffuser

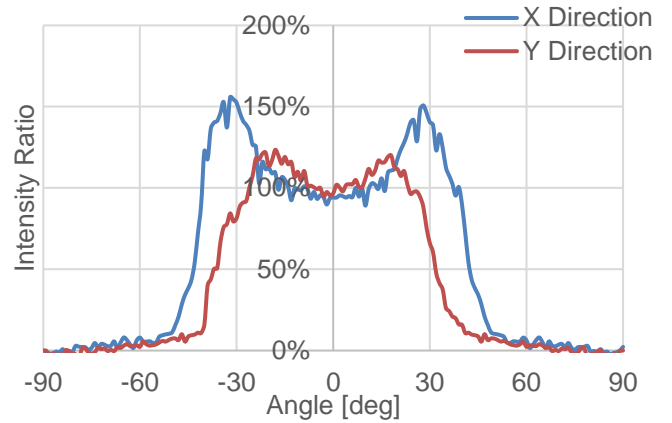

• 90×69deg Diffuser

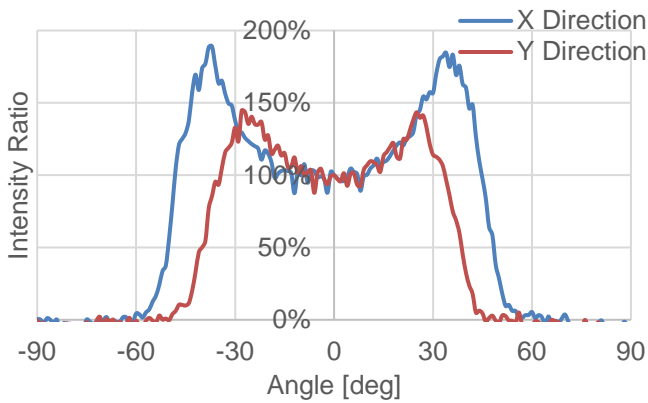

• 110×85deg Diffuser

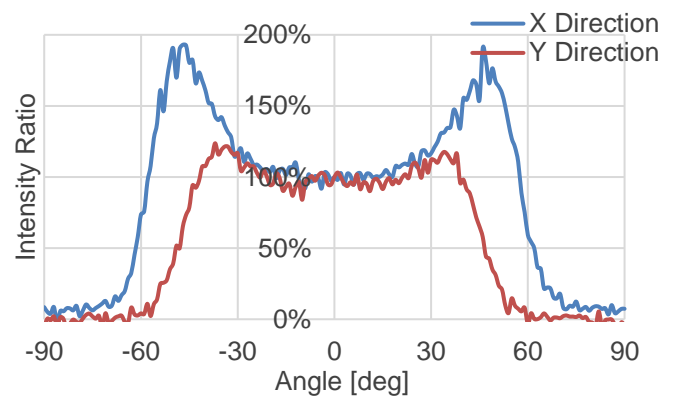

●Far Field Pattern (Clear Glass Type)

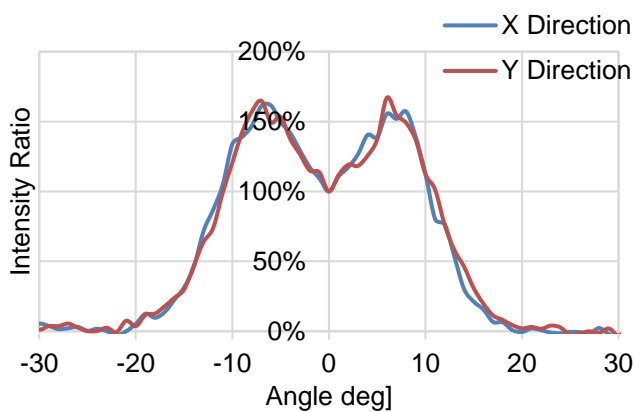

[Type List]

RLD94SAQ8-00A	Clear Glass
RLD94SAQ8-10A	60×45deg
RLD94SAQ8-20A	72×55deg
RLD94SAQ8-30A	90×69deg
RLD94SAQ8-40A	110×85deg
RLD94SAQ8-50A(TBD)	120×90deg(TBD)

[Condition]

- If=3A (Pulse 100Hz Duty1%(on time 100μsec.))
- Ta = 25°C

Notes

- 1) The information contained herein is subject to change without notice.
- 2) Before you use our Products, please contact our sales representative and verify the latest specifications.
- 3) Although ROHM is continuously working to improve product reliability and quality, semiconductors can break down and malfunction due to various factors. Therefore, in order to prevent personal injury or fire arising from failure, please take safety measures such as complying with the derating characteristics, implementing redundant and fire prevention designs, and utilizing backups and fail-safe procedures. ROHM shall have no responsibility for any damages arising out of the use of our Products beyond the rating specified by ROHM.
- 4) Examples of application circuits, circuit constants and any other information contained herein are provided only to illustrate the standard usage and operations of the Products. The peripheral conditions must be taken into account when designing circuits for mass production.
- 5) The technical information specified herein is intended only to show the typical functions of and examples of application circuits for the Products. ROHM does not grant you, explicitly or implicitly, any license to use or exercise intellectual property or other rights held by ROHM or any other parties. ROHM shall have no responsibility whatsoever for any dispute arising out of the use of such technical information.
- 6) The Products are intended for use in general electronic equipment (i.e. AV/OA devices, communication, consumer systems, gaming/entertainment sets) as well as the applications indicated in this document.
- 7) The Products specified in this document are not designed to be radiation tolerant.
- 8) For use of our Products in applications requiring a high degree of reliability (as exemplified below), please contact and consult with a ROHM representative : transportation equipment (i.e. cars, ships, trains), primary communication equipment, traffic lights, fire/crime prevention, safety equipment, medical systems, servers, solar cells, and power transmission systems.
- 9) Do not use our Products in applications requiring extremely high reliability, such as aerospace equipment, nuclear power control systems, and submarine repeaters.
- 10) ROHM shall have no responsibility for any damages or injury arising from non-compliance with the recommended usage conditions and specifications contained herein.
- 11) ROHM has used reasonable care to ensure the accuracy of the information contained in this document. However, ROHM does not warrants that such information is error-free, and ROHM shall have no responsibility for any damages arising from any inaccuracy or misprint of such information.
- 12) Please use the Products in accordance with any applicable environmental laws and regulations, such as the RoHS Directive. For more details, including RoHS compatibility, please contact a ROHM sales office. ROHM shall have no responsibility for any damages or losses resulting non-compliance with any applicable laws or regulations.
- 13) When providing our Products and technologies contained in this document to other countries, you must abide by the procedures and provisions stipulated in all applicable export laws and regulations, including without limitation the US Export Administration Regulations and the Foreign Exchange and Foreign Trade Act.
- 14) This document, in part or in whole, may not be reprinted or reproduced without prior consent of ROHM.



Thank you for your accessing to ROHM product informations.
More detail product informations and catalogs are available, please contact us.

ROHM Customer Support System

<http://www.rohm.com/contact/>

General Precaution

1. Before you use our Products, you are requested to carefully read this document and fully understand its contents. ROHM shall not be in any way responsible or liable for failure, malfunction or accident arising from the use of any ROHM's Products against warning, caution or note contained in this document.
2. All information contained in this document is current as of the issuing date and subject to change without any prior notice. Before purchasing or using ROHM's Products, please confirm the latest information with a ROHM sales representative.
3. The information contained in this document is provided on an "as is" basis and ROHM does not warrant that all information contained in this document is accurate and/or error-free. ROHM shall not be in any way responsible or liable for any damages, expenses or losses incurred by you or third parties resulting from inaccuracy or errors of or concerning such information.