

The RPT-38PB3F is a silicon planar phototransistor. Since it is molded in plastic with a visible light filter, there is almost no effect from stray light. It is particularly suited for use with a ROHM SIR-34ST3F infrared light emitting diode.

●Applications

- Optical control equipment
- Receiver for sensors

●Features

- 1) High sensitivity.
- 2) Almost no effect from stray light.

●Dimensions (Unit : mm)

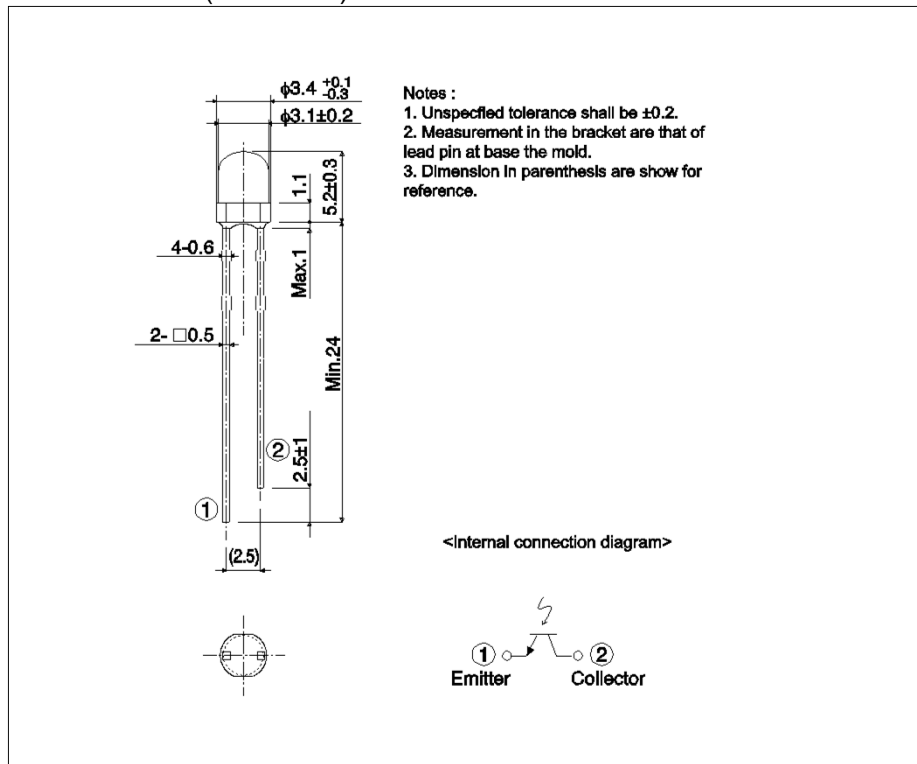

●Outline



●Absolute maximum ratings ($T_a = 25^\circ\text{C}$)

Parameter	Symbol	Value	Unit
Collector-emitter voltage	V_{CEO}	32	V
Emitter-collector voltage	V_{ECO}	5	V
Collector current	I_{C}	30	mA
Collector power dissipation	P_{C}	150	mW
Operating temperature	T_{opr}	-25 to +85	$^\circ\text{C}$
Storage temperature	T_{stg}	-30 to +85	$^\circ\text{C}$

●Electrical and optical characteristics (T_a = 25°C)

Parameter	Symbol	Conditions	Values			Unit
			Min.	Typ.	Max.	
Light current	I _C	V _{CE} =5V, E=500Lx	2.0	-	-	mA
Dark current	I _{CEO}	V _{CE} =10V (Black box)	-	-	0.5	μA
Peak sensitivity wavelength	λ _p	-	-	800	-	nm
Collector-emitter saturationvoltage	V _{CE(sat)}	I _C =1mA, E=500Lx	-	-	0.4	V
Half-angle	θ _{1/2}	-	-	±36	-	deg
Response time	tr·tf	V _{CC} =5V, I _C =1mA, R _L =100Ω	-	10	-	μs

●Classified table of rank

Item	Light current : I _C	Unit
L	2.0 to 5.0	mA
M	3.0 to 8.0	mA
N	5.5 to 13.0	mA
P	10.0 to 25.0	mA

●Electrical and optical characteristics curves

Fig.1 Dark Current vs. Ambient Temperature

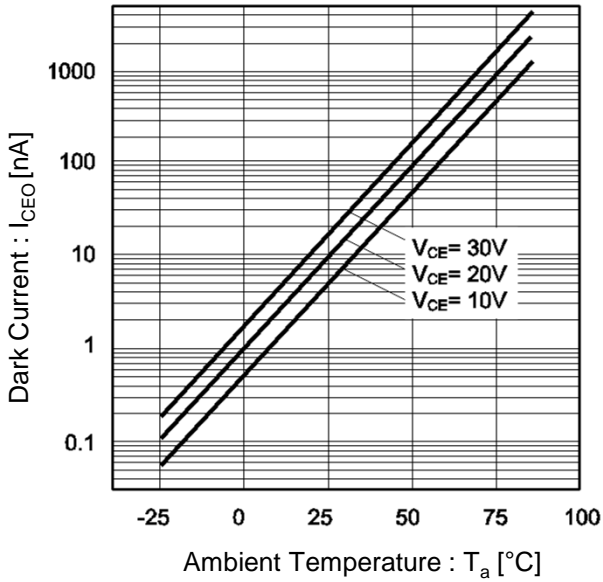

Fig.2 Relative Output vs. Ambient Temperature

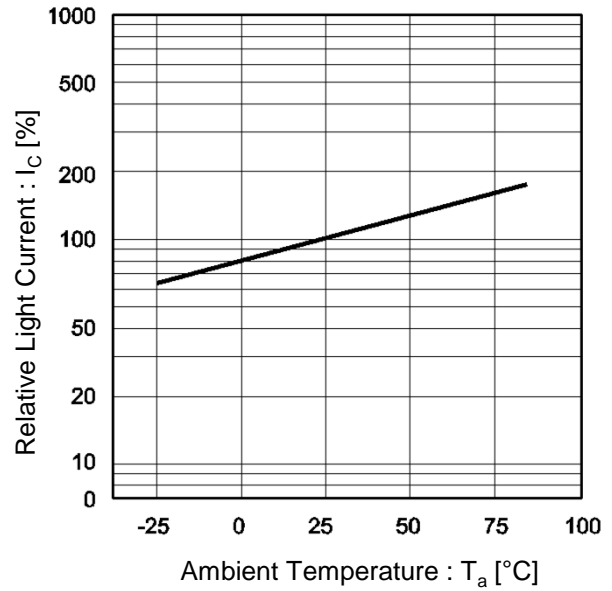

Fig.3 Light Current vs. Emitter Strength

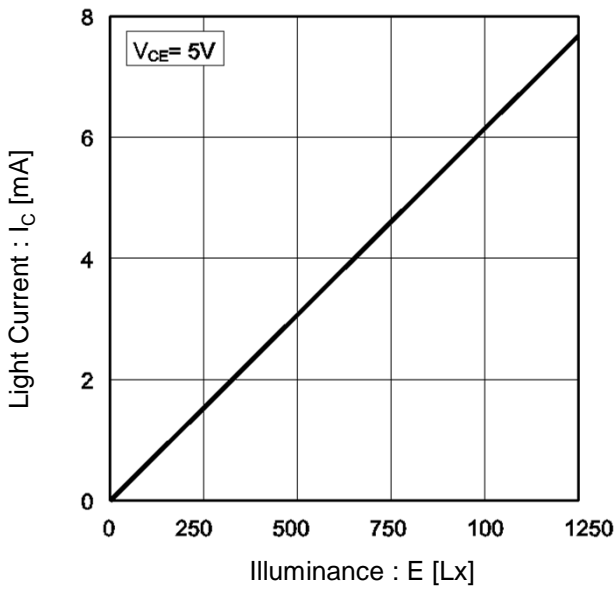
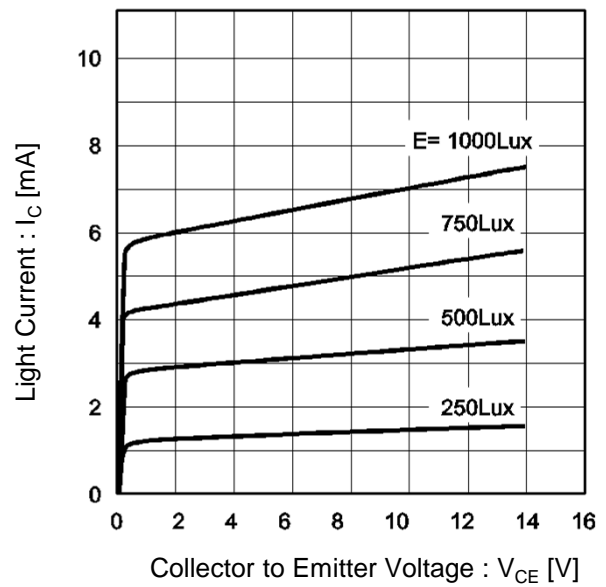

Fig.4 Output Characteristics



●Electrical and optical characteristics curves

Fig.5 Spectral Sensitivity

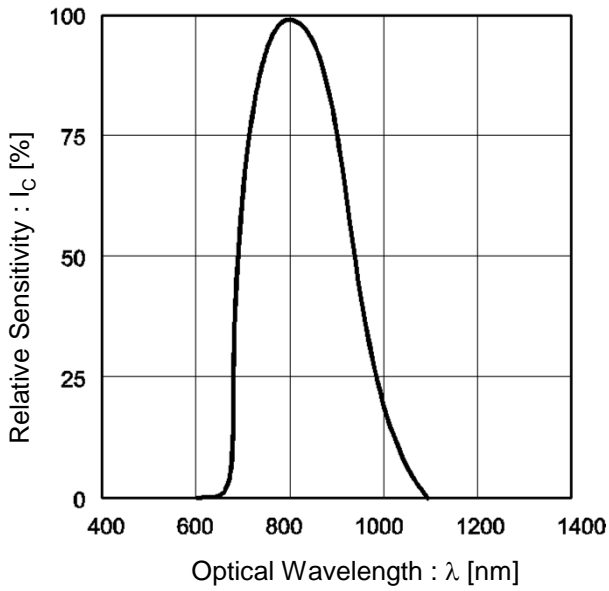

Fig.6 Collector Power Dissipation vs. Ambient Temperature

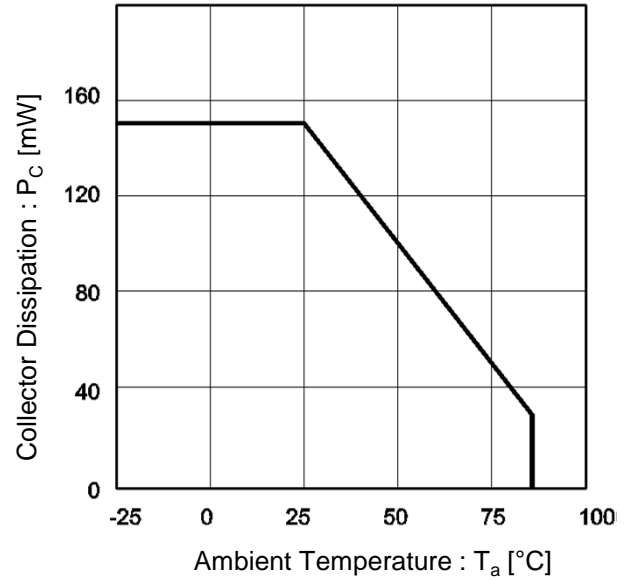
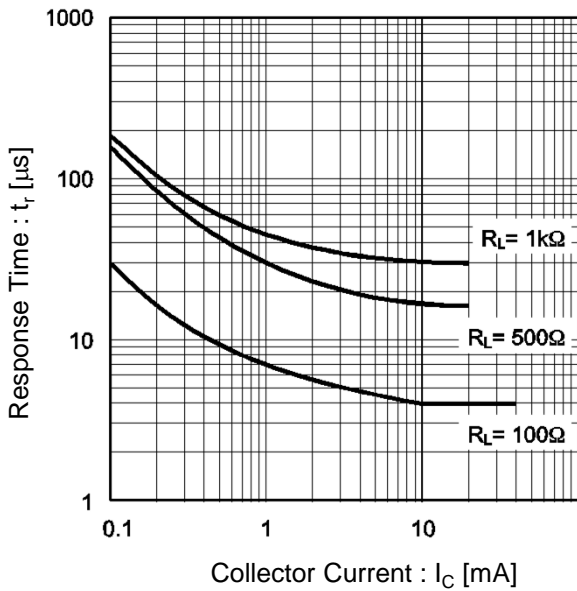
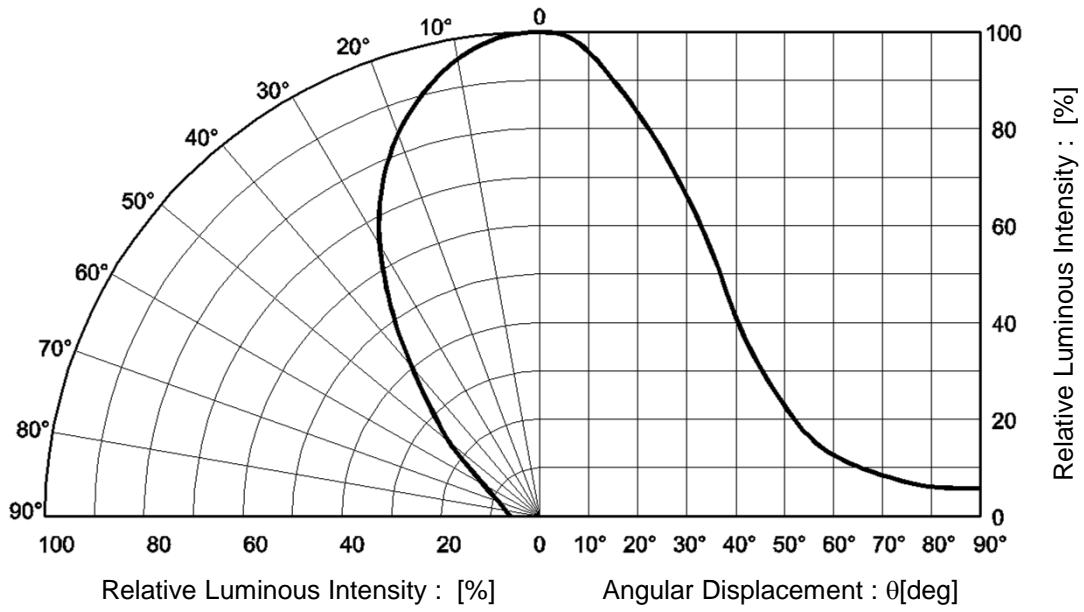

Fig.7 Response time vs. Collector Current



●Electrical and optical characteristics curves

Fig.8 Directional Pattern



Notes

- 1) The information contained herein is subject to change without notice.
- 2) Before you use our Products, please contact our sales representative and verify the latest specifications.
- 3) Although ROHM is continuously working to improve product reliability and quality, semiconductors can break down and malfunction due to various factors. Therefore, in order to prevent personal injury or fire arising from failure, please take safety measures such as complying with the derating characteristics, implementing redundant and fire prevention designs, and utilizing backups and fail-safe procedures. ROHM shall have no responsibility for any damages arising out of the use of our Products beyond the rating specified by ROHM.
- 4) Examples of application circuits, circuit constants and any other information contained herein are provided only to illustrate the standard usage and operations of the Products. The peripheral conditions must be taken into account when designing circuits for mass production.
- 5) The technical information specified herein is intended only to show the typical functions of and examples of application circuits for the Products. ROHM does not grant you, explicitly or implicitly, any license to use or exercise intellectual property or other rights held by ROHM or any other parties. ROHM shall have no responsibility whatsoever for any dispute arising out of the use of such technical information.
- 6) The Products are intended for use in general electronic equipment (i.e. AV/OA devices, communication, consumer systems, gaming/entertainment sets) as well as the applications indicated in this document.
- 7) The Products specified in this document are not designed to be radiation tolerant.
- 8) For use of our Products in applications requiring a high degree of reliability (as exemplified below), please contact and consult with a ROHM representative : transportation equipment (i.e. cars, ships, trains), primary communication equipment, traffic lights, fire/crime prevention, safety equipment, medical systems, servers, solar cells, and power transmission systems.
- 9) Do not use our Products in applications requiring extremely high reliability, such as aerospace equipment, nuclear power control systems, and submarine repeaters.
- 10) ROHM shall have no responsibility for any damages or injury arising from non-compliance with the recommended usage conditions and specifications contained herein.
- 11) ROHM has used reasonable care to ensure the accuracy of the information contained in this document. However, ROHM does not warrants that such information is error-free, and ROHM shall have no responsibility for any damages arising from any inaccuracy or misprint of such information.
- 12) Please use the Products in accordance with any applicable environmental laws and regulations, such as the RoHS Directive. For more details, including RoHS compatibility, please contact a ROHM sales office. ROHM shall have no responsibility for any damages or losses resulting non-compliance with any applicable laws or regulations.
- 13) When providing our Products and technologies contained in this document to other countries, you must abide by the procedures and provisions stipulated in all applicable export laws and regulations, including without limitation the US Export Administration Regulations and the Foreign Exchange and Foreign Trade Act.
- 14) This document, in part or in whole, may not be reprinted or reproduced without prior consent of ROHM.



Thank you for your accessing to ROHM product informations.
More detail product informations and catalogs are available, please contact us.

ROHM Customer Support System

<http://www.rohm.com/contact/>