

BM2P016T-EVK-004 Schematics

$V_{IN} = 90 \sim 264 \text{ Vac}$, $V_{OUT} = 24 \text{ V}$

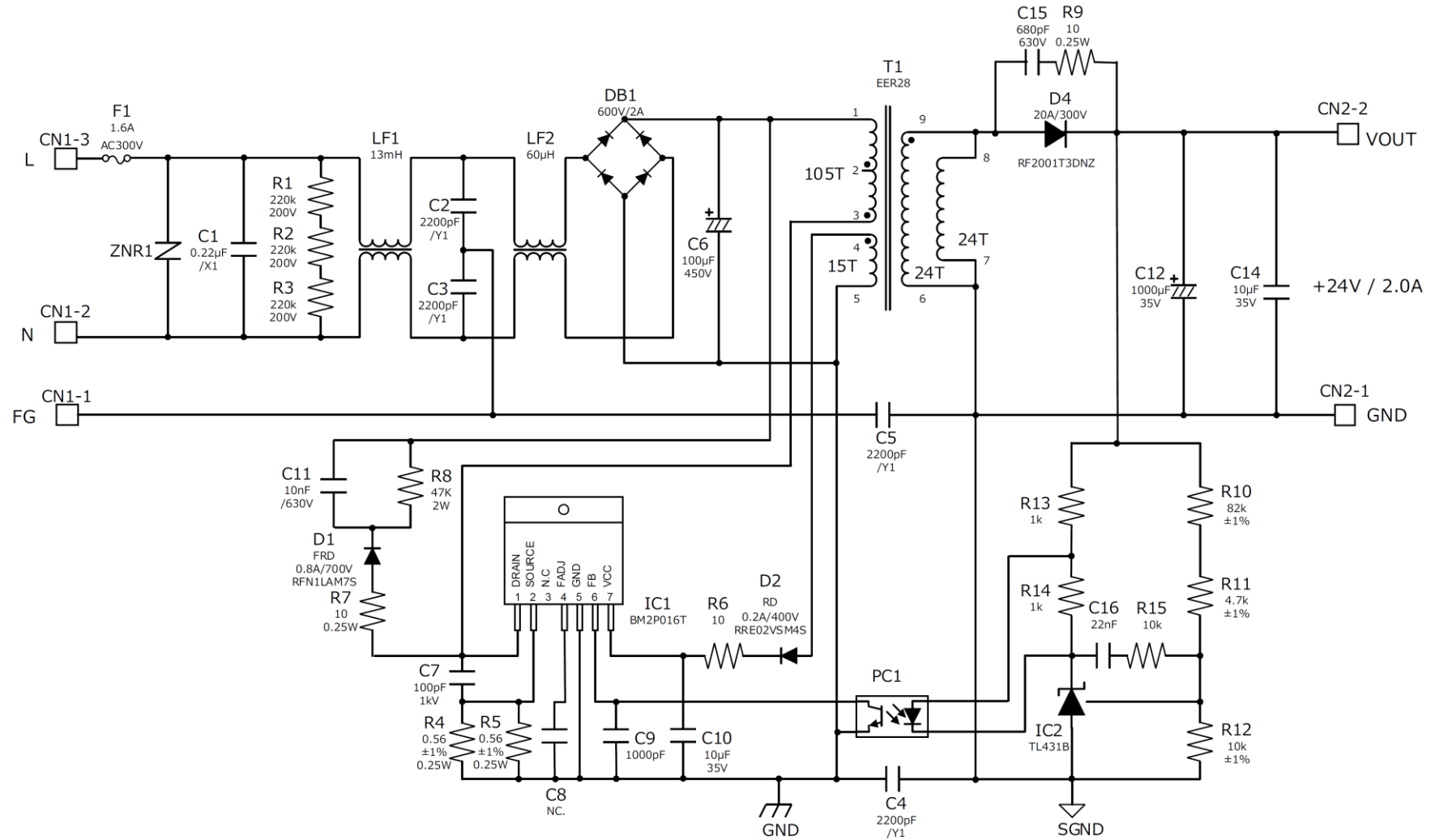

Important Notes on the Use of Reference Designs

- 1) The contents of this document are subject to change without notice for the purpose of improvement.
- 2) ROHM provides reference designs (including, but not limited to, circuit diagrams, layout data, parts lists, reference boards and their evaluation results, etc.) and all materials related to evaluation boards (hereinafter collectively referred to as "Reference Designs, etc.") to customers for the purpose of referencing them in the development of devices, equipment, software, etc. incorporating ROHM products (hereinafter collectively referred to as "Customer Products"). The design, verification, etc. required for the development of the Customer's Product shall be done at the customer's responsibility and expense. In no event shall the customer use the Reference Designs, etc. for any purpose other than the purpose mentioned above.
- 3) Reference Designs, etc. are provided on an "as is" basis. ROHM disclaims all warranties, express or implied, including, but not limited to, warranties of usefulness, functionality, accuracy, merchantability, and fitness for a particular purpose. In no event shall ROHM be liable for any damages (including, but not limited to, lost profits or other incidental, consequential, or punitive damages) arising out of, related to or in connection with the use of or application of the Reference Designs, etc. whether in contract or tort. For the avoidance of doubt, ROHM does not warrant that the Reference Designs, etc. will work with the Customer's Product.
- 4) When using Reference Designs, etc. be sure to request and verify the latest specifications (including the specifications of the products that compose the Reference Design, etc.) separately.
- 5) The customer shall be responsible for implementing safety measures such as derating, redundant design, fire prevention, backup, and fail-safe measures, etc., to prevent personal injury, fire damage, etc., caused by the Customer's Product developed with Reference Designs, etc. ROHM assumes no liability whatsoever for any use in excess of the ratings or in case of failure to observe the instructions for use.
- 6) The application circuit examples, constants, and other information provided in Reference Designs, etc. are intended to illustrate standard operation and usage. Therefore, when designing for mass production, please take into account various external conditions.
- 7) Reference Designs, etc. are intended to show typical operations and examples of application circuits, etc., and do not constitute a license, express or implied, to implement or use any intellectual property rights or any other rights of ROHM or any other company. ROHM shall not be liable for any disputes arising from, related to or in connection with the use of the Reference Designs, etc.
- 8) Please make sure to contact ROHM and obtain ROHM's consent before using the Reference Designs, etc. for the following Customer's Product that requires particularly high reliability. Transportation equipment (in-vehicle, ship, railroad, etc.), trunk line communication equipment, traffic signal equipment, disaster and security equipment, safety equipment, medical equipment, servers, solar cells, power transmission systems, etc.
- 9) Do not use Reference Designs, etc. for the following Customer's Product that requires extremely high reliability. Aerospace equipment, nuclear power control equipment, submarine relay equipment, etc.
- 10) Do not use Reference Designs, etc. for military use, such as development of weapons of mass destruction, or for any other military purpose.
- 11) ROHM does not assume any liability for any accidents or damages caused by non-compliance with the descriptions in this document.
- 12) The information contained in this document has been carefully prepared to ensure accuracy. However, ROHM shall not be liable for any loss or damage incurred by customers due to errors or misprints in this document.
- 13) Do not reproduce or duplicate any part of this document in any form or by any means without ROHM's permission.



Thank you for your accessing to ROHM product informations.
More detail product informations and catalogs are available, please contact us.

ROHM Customer Support System

<http://www.rohm.com/contact/>