

(C-002-D) DC-DC Boost Converter (Discrete)

Simulation Parameters (Dialog)

Name	Content	unit	Default Value	Variable Range
L	Inductive Load	H	1.2m	1n ~ 1
RI	Parasitic Resistance	Ω	100m	1u ~ 100m
Cout	Output Capacitor	F	100u	1n ~ 1
Vc_init	Initial Voltage of Cout	V	500	0 ~ 1200
ESR	Equivalent Series Resistance	Ω	10m	1u ~ 100m
Rth	Thermal Resistance	K/W	0.5	1m ~ 100
Thcap	Thermal Capacitance	J/K	10m	1m ~ 100
TGND	Thermal GND Temperature	$^{\circ}\text{C}$	25	-40 ~ 175

Simulation Parameters (Table)

Name	Content	unit	Default Value	Variable Range
Test_time	Test time in simulation	s	0.3	100u ~ 0.5
fs	Switching Frequency	Hz	50k	10k ~ 100k
Vin	Input Voltage	V	400	1 ~ 1000
Vout	Output Voltage	V	800	10 ~ 1200
Pout	Output Power	W	3.3k	1 ~ 10k
Rg_on	Gate Resistance (Source)	Ω	10	0.1 ~ 100
Rg_off	Gate Resistance (Sink)	Ω	3.3	0.1 ~ 100
T_init	Initial Junction Temperature	$^{\circ}\text{C}$	25	-40 ~ 175

Simulation Circuit

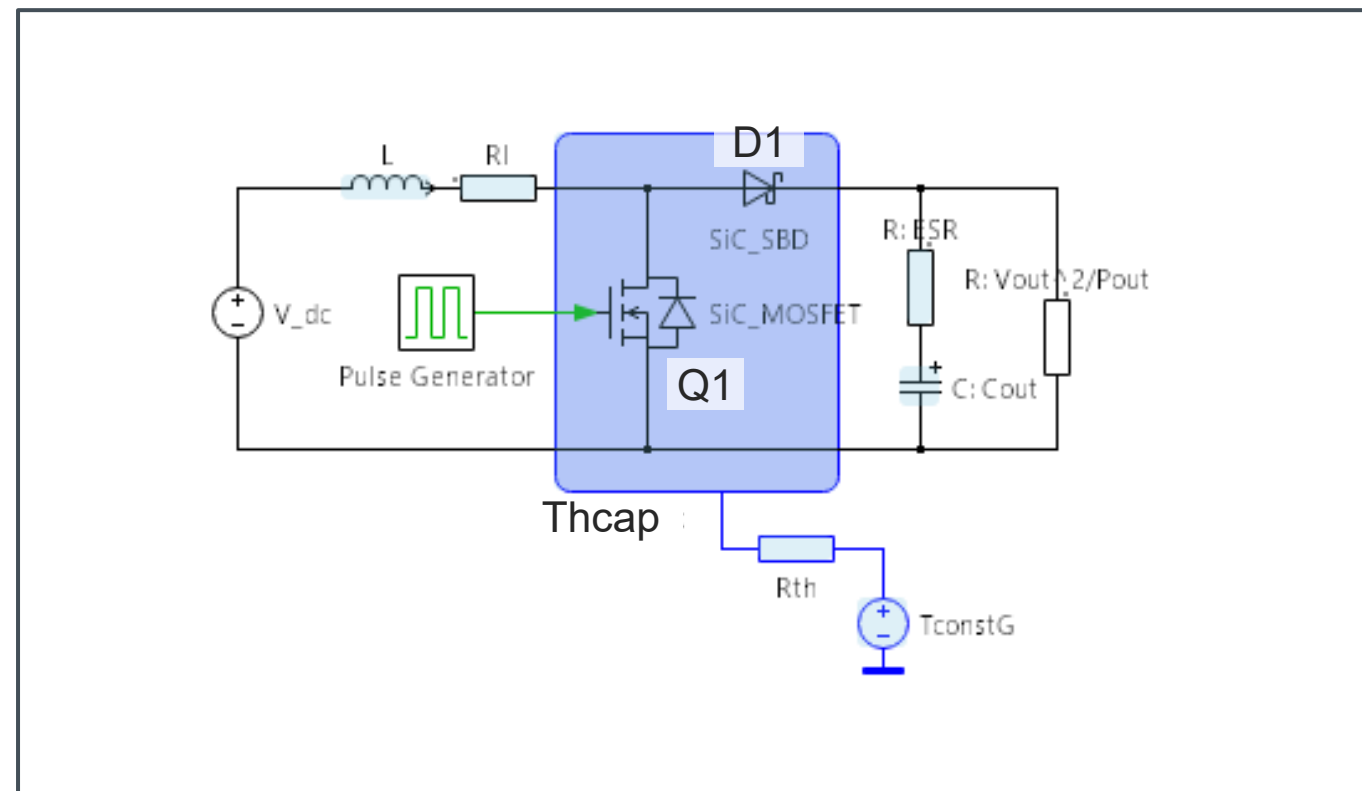

Name	Device Type	Part No.	Specification
Q1	SiC MOSFET	SCT4036KR	1200V/ 43A/ 36m Ω / TO-247-4L
D1	SiC Schottky Barrier Diode	SCS320AG	650V/ 20A/ TO-220ACGE

Simulation Screen Overview

Schematic window

- Dialog parameters setting
- Results display

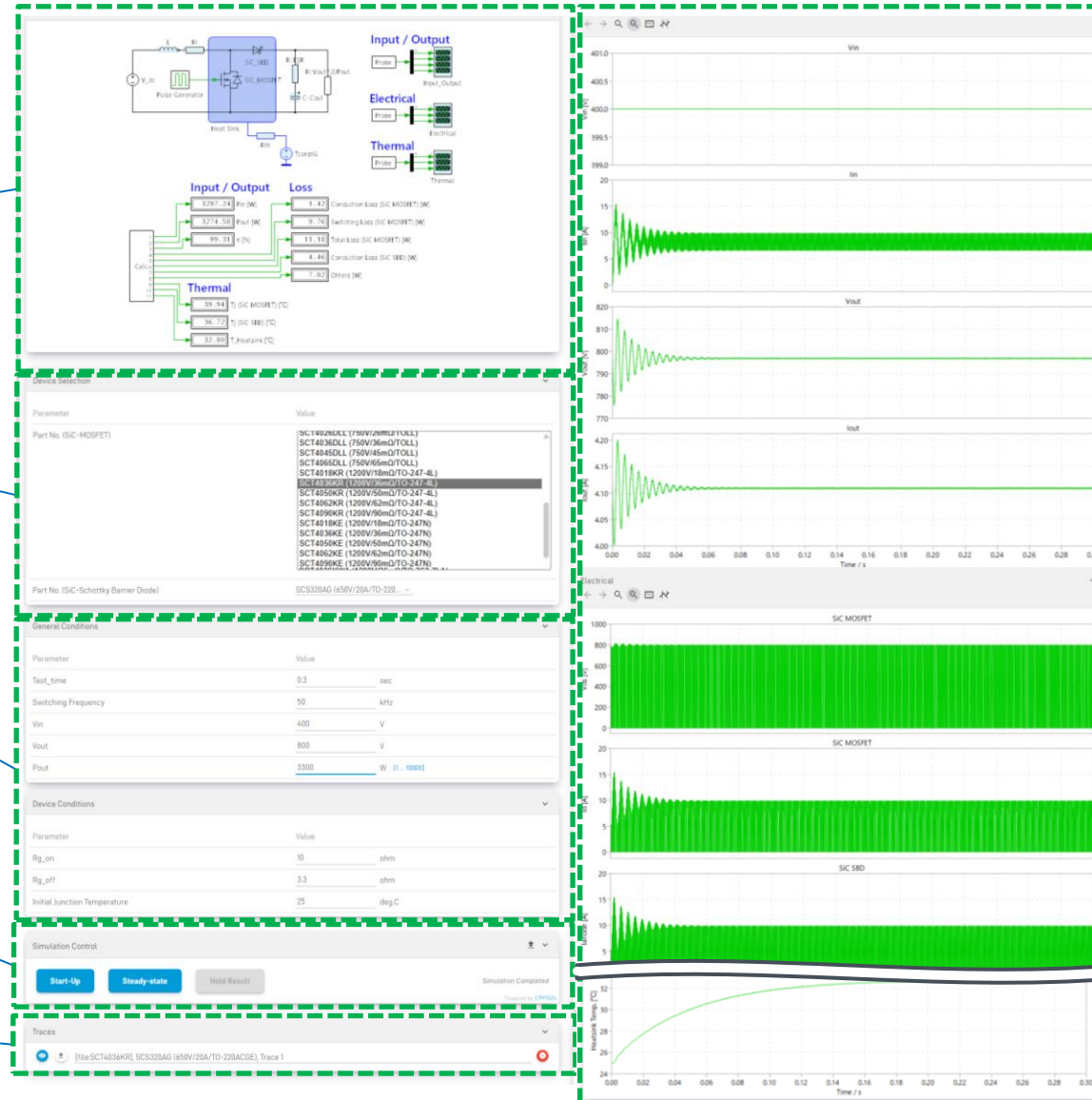

Waveforms

General Conditions

Simulation control

Trace selection

Input and Output

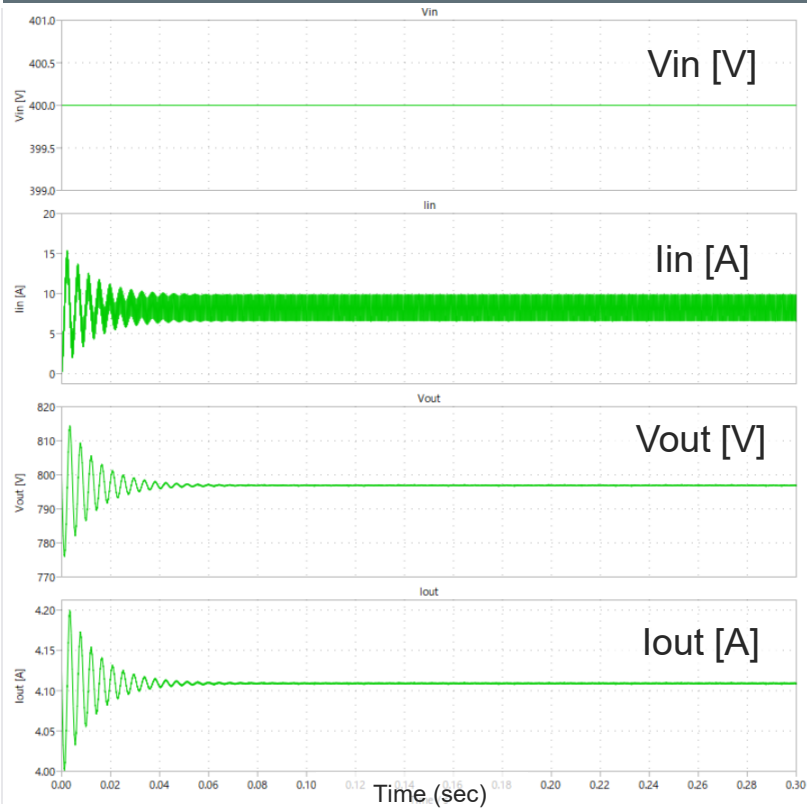

Contents	Results
Input Power : Pin	3.297 kW
Output Power: Pout	3.275 kW
Efficiency: η	99.31 %

Electrical

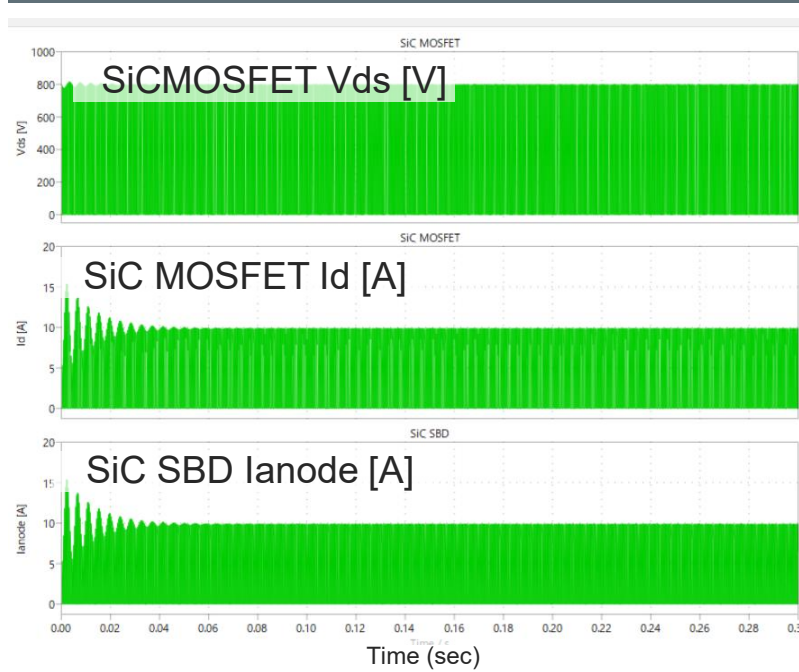

Contents	Results
Conduction Loss (SiC MOSFET)	1.42 W
Switching Loss (SiC MOSFET)	9.76 W
Total Loss (SiC MOSFET)	11.18 W
Conduction Loss (SiC SBD)	4.46 W
Loss (Others)	7.02 W

Thermal

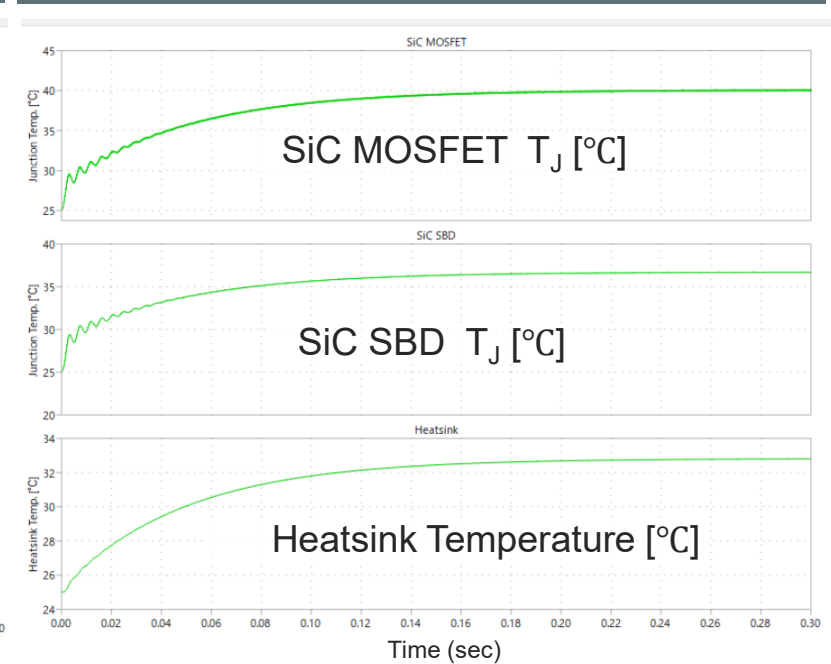

Contents	Results
T _j (SiC MOSFET)	39.94 °C
T _j (SiC SBD)	36.72 °C
T_Heatsink	32.80 °C

How to change the devices

The figure of "(A-011-D) DC-AC Totem-Pole PFC Diode Rectification (Discrete)" is used as an example in this page.

Device Selection

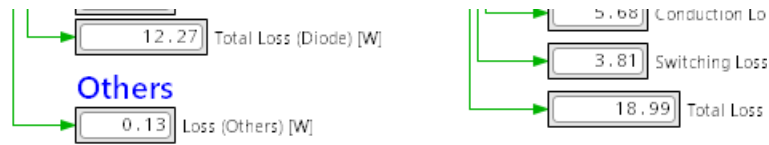

Device Selection	
Parameter	Value
Part No. (SiC-MOSFET)	SCT4065DR (750V/65mΩ/TO-220...
Part No. (SiC-Schottky Barrier Diode)	SCS320AG (650V/20A/TO-220...



Device Selection	
Parameter	Value
Part No. (SiC-MOSFET)	SCT4065DR (750V/65mΩ/TO-220...
Part No. (SiC-Schottky Barrier Diode)	SCS320AG (650V/20A/TO-220...

- [SCT4036DWA \(750V/36mΩ/TO-263-7LA\)](#)
- [SCT4045DWA \(750V/45mΩ/TO-263-7LA\)](#)
- [SCT4065DWA \(750V/65mΩ/TO-263-7LA\)](#)
- [SCT4013DLL \(750V/13mΩ/TOLL\)](#)**
- [SCT4026DLL \(750V/26mΩ/TOLL\)](#)
- [SCT4036DLL \(750V/36mΩ/TOLL\)](#)
- [SCT4045DLL \(750V/45mΩ/TOLL\)](#)

Over your mouse cursor to the device name that you want to change and click the left button of the mouse.

Available device lists are appeared like the above, and you can select a favorite device from these.

How to change Dialog parameters

The figure of "(A-011-D) DC-AC Totem-Pole PFC Diode Rectification (Discrete)" is used as an example in this page.

- Symbols whose parameters can be changed are colored light-blue in the circuit diagram.
- Over your mouse cursor to the symbol that you want to change the parameter and the symbol color is turned to blue (e.g. "V_ac" symbol in the below).
- Click the mouse's left button.



- A new window like the below is opened.
- You can change the parameters by entering the value directly* or selecting radio buttons.
- Push "Apply" button after changing all parameters.

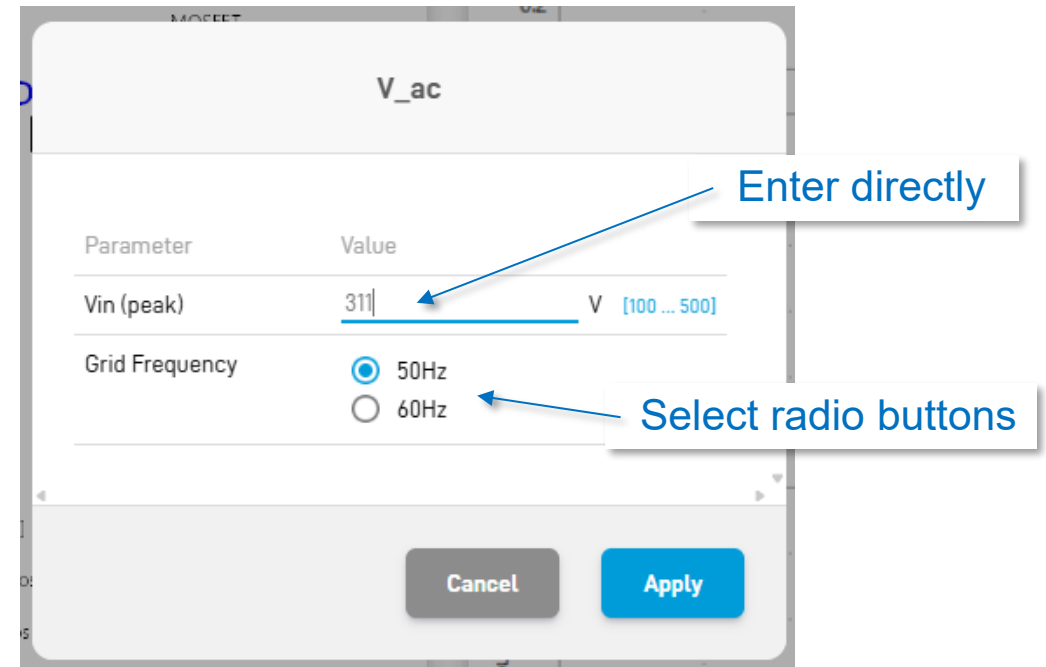

*Note: Parameters can be entered directly are limited by Min. and Max. values to avoid unexpected system errors.
(e.g. "Vin(peak)" is limited between 100 and 500V in the above.)

How to change Table parameters

The figure of "(A-011-D) DC-AC Totem-Pole PFC Diode Rectification (Discrete)" is used as an example in this page.

ROHM PLECS Simulator
Circuit Information



2026 March
68UG111E Rev.001

Table parameters

General Conditions

Parameter	Value
Test_time	1 sec
Switching Frequency	60000 Hz

Device Conditions

General Conditions

Parameter	Value
Test_time	1 sec
Switching Frequency	<u>20000</u> Hz [10000 ... 100000]

Device Conditions

Choose the parameter that you want change on the parameter tables (e.g. "60kHz" of Switching Frequency in the left figure.)

- A blue under-line and variable range of the parameter are appeared.
- Then, you can change the parameters by entering the value directly " (e.g. "60kHz" was changed to "20kHz").

Notice

- 1) The information contained in this document is intended to introduce ROHM Group (hereafter referred to as ROHM) products. When using ROHM products, please verify the latest specifications or datasheets before use.
- 2) ROHM products are designed and manufactured for use in general electronic equipment and applications (such as Audio Visual equipment, Office Automation equipment, telecommunication equipment, home appliances, amusement devices, etc.) or specified in the datasheets. Therefore, please contact the ROHM sales representative before using ROHM products in equipment or devices requiring extremely high reliability and whose failure or malfunction may cause danger or injury to human life or body or other serious damage (such as medical equipment, transportation, traffic, aircraft, spacecraft, nuclear power controllers, fuel control, automotive equipment including car accessories, etc. hereafter referred to as Specific Applications). Unless otherwise agreed in writing by ROHM in advance, ROHM shall not be in any way responsible or liable for any damages, expenses, or losses incurred by you or third parties arising from the use of ROHM Products for Specific Applications.
- 3) Electronic components, including semiconductors, can fail or malfunction at a certain rate. Please be sure to implement, at your own responsibilities, adequate safety measures including but not limited to fail-safe design against physical injury, and damage to any property, which a failure or malfunction of products may cause.
- 4) The information contained in this document, including application circuit examples and their constants, is intended to explain the standard operation and usage of ROHM products, and is not intended to guarantee, either explicitly or implicitly, the operation of the product in the actual equipment it will be used. As a result, you are solely responsible for it, and you must exercise your own independent verification and judgment in the use of such information contained in this document. ROHM shall not be in any way responsible or liable for any damages, expenses, or losses incurred by you or third parties arising from the use of such information.
- 5) When exporting ROHM products or technologies described in this document to other countries, you must abide by the procedures and provisions stipulated in all applicable export laws and regulations, such as the Foreign Exchange and Foreign Trade Act and the US Export Administration Regulations, and follow the necessary procedures in accordance with these provisions.
- 6) The technical information and data described in this document, including typical application circuits, are examples only and are not intended to guarantee to be free from infringement of third parties intellectual property or other rights. ROHM does not grant any license, express or implied, to implement, use, or exploit any intellectual property or other rights owned or controlled by ROHM or any third parties with respect to the information contained herein.
- 7) No part of this document may be reprinted or reproduced in any form by any means without the prior written consent of ROHM.
- 8) All information contained in this document is current as of the date of publication and subject to change without notice. Before purchasing or using ROHM products, please confirm the latest information with the ROHM sales representative.
- 9) ROHM does not warrant that the information contained herein is error-free. ROHM shall not be in any way responsible or liable for any damages, expenses, or losses incurred by you or third parties resulting from errors contained in this document.



Thank you for your accessing to ROHM product informations.
More detail product informations and catalogs are available, please contact us.

ROHM Customer Support System

<https://www.rohm.com/contactus>