

Dear customer

LAPIS Semiconductor Co., Ltd. ("LAPIS Semiconductor"), on the 1st day of October, 2020, implemented the incorporation-type company split (shinsetsu-bunkatsu) in which LAPIS established a new company, LAPIS Technology Co., Ltd. ("LAPIS Technology") and LAPIS Technology succeeded LAPIS Semiconductor's LSI business.

Therefore, all references to "LAPIS Semiconductor Co., Ltd.", "LAPIS Semiconductor" and/or "LAPIS" in this document shall be replaced with "LAPIS Technology Co., Ltd."

Furthermore, there are no changes to the documents relating to our products other than the company name, the company trademark, logo, etc.

Thank you for your understanding.

LAPIS Technology Co., Ltd.

October 1, 2020

EASE1000 V2

User's Manual

3rd Edition

Issue Date: Mar. 23, 2020



NOTES

- 1) The information contained herein is subject to change without notice.
- 2) Although LAPIS Semiconductor is continuously working to improve product reliability and quality, semiconductors can break down and malfunction due to various factors. Therefore, in order to prevent personal injury or fire arising from failure, please take safety measures such as complying with the derating characteristics, implementing redundant and fire prevention designs, and utilizing backups and fail-safe procedures. LAPIS Semiconductor shall have no responsibility for any damages arising out of the use of our Products beyond the rating specified by LAPIS Semiconductor.
- 3) Examples of application circuits, circuit constants and any other information contained herein are provided only to illustrate the standard usage and operations of the Products. The peripheral conditions must be taken into account when designing circuits for mass production.
- 4) The technical information specified herein is intended only to show the typical functions of the Products and examples of application circuits for the Products. No license, expressly or implied, is granted hereby under any intellectual property rights or other rights of LAPIS Semiconductor or any third party with respect to the information contained in this document; therefore LAPIS Semiconductor shall have no responsibility whatsoever for any dispute, concerning such rights owned by third parties, arising out of the use of such technical information.
- 5) The Products are intended for use in general electronic equipment (i.e. AV/OA devices, communication, consumer systems, gaming/entertainment sets) as well as the applications indicated in this document.
- 6) The Products specified in this document are not designed to be radiation tolerant.
- 7) For use of our Products in applications requiring a high degree of reliability (as exemplified below), please contact and consult with a LAPIS Semiconductor representative: transportation equipment (i.e. cars, ships, trains), primary communication equipment, traffic lights, fire/crime prevention, safety equipment, medical systems, servers, solar cells, and power transmission systems.
- 8) Do not use our Products in applications requiring extremely high reliability, such as aerospace equipment, nuclear power control systems, and submarine repeaters.
- 9) LAPIS Semiconductor shall have no responsibility for any damages or injury arising from non-compliance with the recommended usage conditions and specifications contained herein.
- 10) LAPIS Semiconductor has used reasonable care to ensure the accuracy of the information contained in this document. However, LAPIS Semiconductor does not warrant that such information is error-free and LAPIS Semiconductor shall have no responsibility for any damages arising from any inaccuracy or misprint of such information.
- 11) Please use the Products in accordance with any applicable environmental laws and regulations, such as the RoHS Directive. For more details, including RoHS compatibility, please contact a ROHM sales office. LAPIS Semiconductor shall have no responsibility for any damages or losses resulting non-compliance with any applicable laws or regulations.
- 12) When providing our Products and technologies contained in this document to other countries, you must abide by the procedures and provisions stipulated in all applicable export laws and regulations, including without limitation the US Export Administration Regulations and the Foreign Exchange and Foreign Trade Act.
- 13) This document, in part or in whole, may not be reprinted or reproduced without prior consent of LAPIS Semiconductor.

Copyright 2018-2020 LAPIS Semiconductor Co., Ltd.

LAPIS Semiconductor Co.,Ltd.

2-4-8 Shinyokohama, Kouhoku-ku,
Yokohama 222-8575, Japan
<http://www.lapis-semi.com/en/>

Table of Contents

CHAPTER 1 PREFACE	4
For Safe and Correct Operation	5
Precautions	6
Description of Term.....	8
CHAPTER 2 GENERAL DESCRIPTION	9
2. General Description	10
2.1 Product Overview	10
2.2 EASE1000 V2 Components	11
2.3 Appearance	12
2.4 Terms of Use.....	13
2.5 Target System Requirements	14
CHAPTER 3 START	19
3 START.....	20
3.1 Starting EASE1000 V2.....	20
CHAPTER 4 FUNCTIONS	22
4 Functions.....	23
4.1 On-chip debug function	23
4.2 Flash writer function	23
4.3 Indicator	23
CHAPTER 5 NOTES ON USE OF EASE1000 V2	25
5 Notes on Use of EASE1000 V2	26
5.1 Notes on Debug	26
5.2 About the 3.3VOUT pin	26
5.3 About Usage Environment.....	26
5.4 About Flash Writing	27
5.5 About Cables.....	27
CHAPTER 6 APPENDICES	28
6. Appendices.....	29
6.1 Form information.....	29
6.2 EASE1000 V2 Interface Cable Appearance.....	29
6.3 Update of Firmware	30



REVISION HISTORY 31

Chapter 1 PREFACE

For Safe and Correct Operation

This user's manual uses various terms and pictorial indications for you to use this product safely and correctly and to prevent harm to you and others and property damages. Their meanings and displays are as follows:

Meaning of term

 Warning	Incorrect handling in defiance of this display may cause death or serious injury.
 Note	Incorrect handling in defiance of this display may cause injury or property damage.

Example of pictorial indication



△ symbol indicates a risk and calls attention. In the picture, a specific note ("Electric shock hazard" in the left figure) is drawn.









● symbol forces an action and indicates the instruction. In the picture, a specific instruction ("Disconnect the power plug from outlet" in the left figure) is drawn.









○ symbol indicates a banned action. In the picture, a specific instruction ("No decomposition" in the left figure) is drawn.





Precautions

Be sure to read this page before using this product.

 Warning	
<ul style="list-style-type: none"> Do not use the product at a voltage other than specified one. It might cause fire, electric shock or failure. 	
<ul style="list-style-type: none"> Do not remodeling the product. It might cause fire, electric shock or failure. 	
<ul style="list-style-type: none"> In case of an abnormal state such as reeking or abnormal odor, rapidly disconnect the power plugs of EASE1000 V2 and any other external powers from outlet. Leaving such situation as it might cause fire, electric shock or failure. 	
<ul style="list-style-type: none"> Do not install the product in a wet or high-humidity environment. It might cause fire, electric shock or failure. 	
<ul style="list-style-type: none"> Do not place any object on the product. It might cause fire, electric shock or failure. 	
<ul style="list-style-type: none"> If you awake to any failure, use caution to rapidly disconnect the power plugs of EASE1000 V2 and any other external powers from outlet. Leaving such situation as it might cause fire or electric shock. 	

 Note	
<ul style="list-style-type: none"> Do not place the product on an unstable or slope place. It might cause falling and injury. 	
<ul style="list-style-type: none"> Do not use the product in a place with excessive vibration, electromagnetic field, or corrosive gas. It might lead to loosened or disconnected connections of various cables, causing fire, electric shock or failures. 	
<ul style="list-style-type: none"> Do not use the product under out of the operational temperature, direct sunlight, or dusty condition. It might cause fire, electric shock or failure. 	
<ul style="list-style-type: none"> Be sure to use the attached cables and accessories. Other items might cause fire, electric shock or failure. 	
<ul style="list-style-type: none"> Do not use the attached cables and accessories on other than this system. It might cause fire, electric shock or failure. 	

Be sure to read this page before using this product.

 Note	
<ul style="list-style-type: none">Do not apply a voltage exceeding the 5.5V to the VTref pin of the EASE1000 V2 Interface cable. It might cause fire, electric shock or failure.	
<ul style="list-style-type: none">The order of power ON and OFF needs extra attention. Incorrect order might cause fire, electric shock or failure.	
<ul style="list-style-type: none">Be sure to turn off the EASE1000 V2 and the user application system before connecting or disconnecting them. Otherwise, it might cause fire, electric shock or failure.	

<ul style="list-style-type: none">The EASE1000 V2 is an unfinished product and intended for research and development and for expert use in the research and development facility only. The EASE1000 V2 is not intended for use for volume production or parts thereof.
<ul style="list-style-type: none">Do not use the EASE1000 V2 for the final check of target LSI of operation.
<ul style="list-style-type: none">The guarantee period to the initial failure of EASE1000 V2 is one year. The obstacle by the wrong usage and reconstruction etc. cannot be guarantee.
<ul style="list-style-type: none">The content specified herein is subject to change for improvement without notice. Therefore, when using the EASE1000 V2, the contents of the manual should check in the newest.

Description of Term

The following shows the terms used in this user's manual and their descriptions.

Term	Description
EASE1000 V2	It is an on-chip emulator for microcontroller of Lapis Semiconductor. It has a function as a writer (hereinafter referred to as flash writer) to a LSI with built-in flash memory, as well as the on-chip emulator function.
DTU8 debugger	It is software to control the on-chip emulator function of EASE1000 V2 and is a Windows application running on the PC.
MWU16 flash multi writer host program	It is software to control the flash multi writer function of EASE1000 V2 and is a Windows application running on the PC.
Target system	It is a board having a LSI to be debugged by EASE1000 V2 or whose flash memory to be written or erased.
Host PC	It is a PC with the DTU8 debugger, MWU16 flash multi writer host program, and USB driver installed.
USB cable	It is a cable to connect EASE1000 V2 with the host PC.
Target LSI	It is LSI debugged by EASE1000 V2.
EASE1000 V2 interface cable	It is an interface cable to connect EASE1000 V2 with the target system.

Chapter 2 General Description

2. General Description

2.1 Product Overview

EASE1000 V2 is an on-chip emulator for Microcontroller (hereinafter referred to as target LSI) of Lapis Semiconductor.

In combination with the DTU8 debugger, it provides the on-chip debug function.

Having the flash writer function as well, EASE1000 V2 can be used as a flash writer in combination with the MWU16 flash multi writer host program.

Target LSI which can be used by EASE1000 V2 is ML62Q1000 series, ML610QXXX, and ML620QXXX.

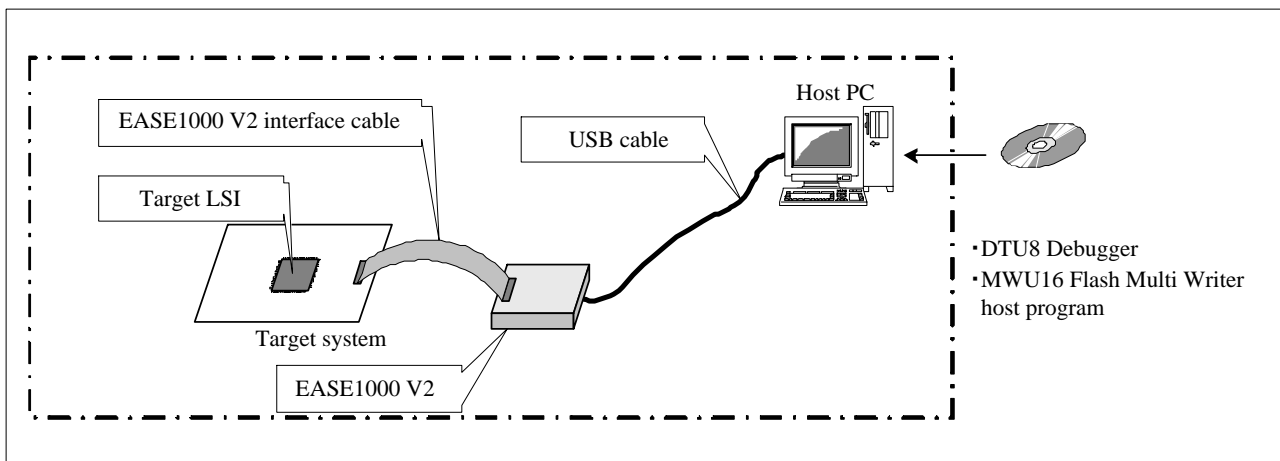

Figure 2-1 EASE1000 V2 System Diagram

2.2 EASE1000 V2 Components

The following shows the EASE1000 V2 components.

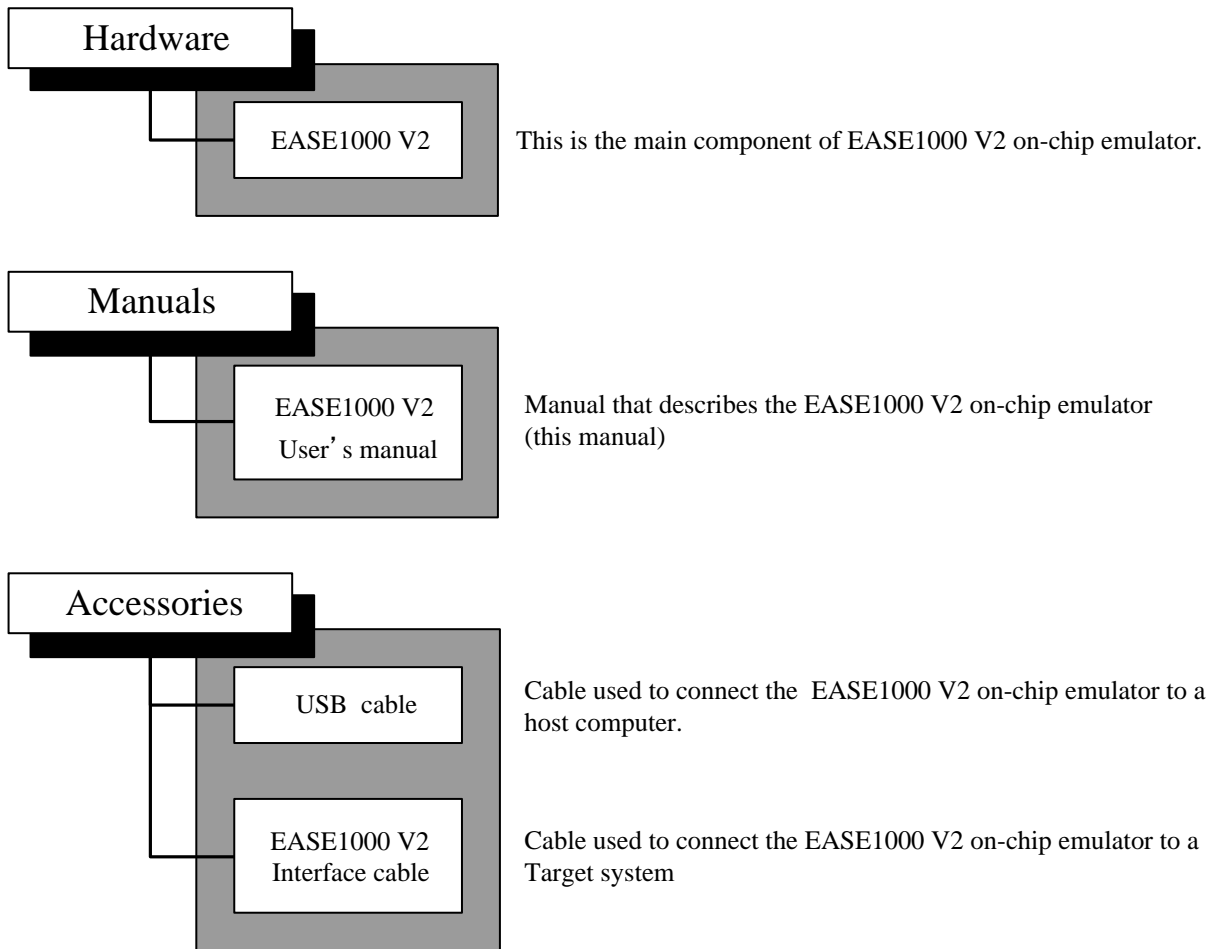

Figure 2-2 EASE1000 V2 Components

2.3 Appearance

The following shows the appearance diagram of EASE1000 V2 and description of each part. In this description, a component surrounded by brackets is the name printed on the case.

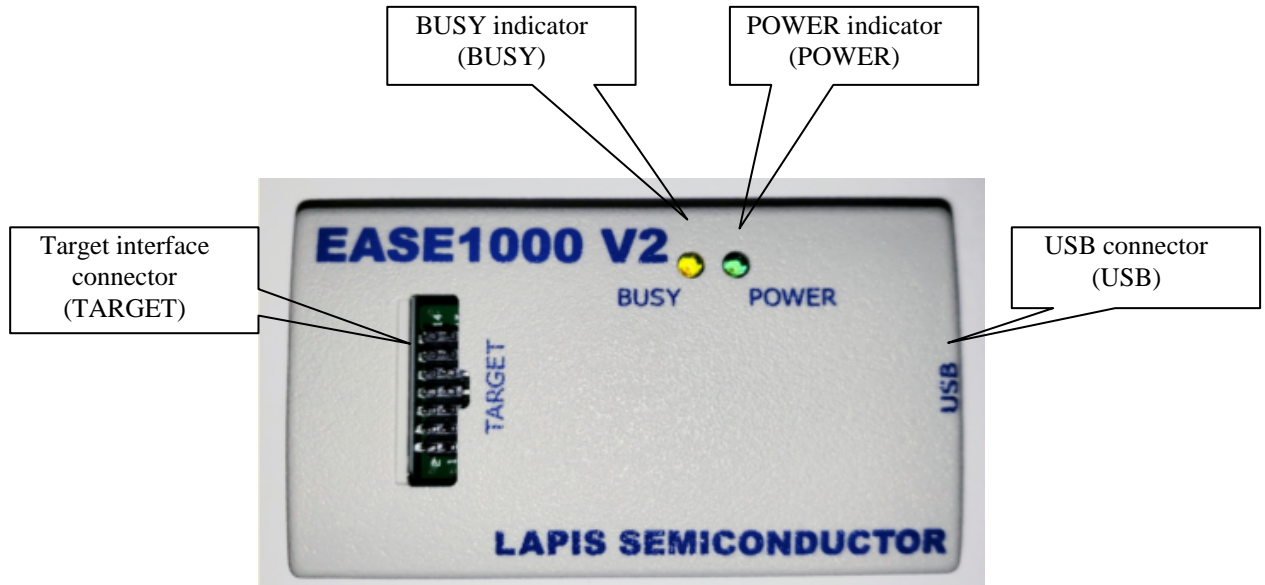

Figure 2-3 EASE1000 V2 Appearance (Top View)

- Target interface connector (TARGET)

A connector to connect EASE1000 V2 with the target system. Connect the supplied EASE1000 V2 interface cable.

- USB connector (USB)

A connector (Type-B mini) to connect EASE1000 V2 with the host PC. Connect the supplied USB cable.

- POWER indicator (POWER)

An LED to indicate the EASE1000 V2 state. It lights up or blinks in green.

For the relationship between the indicator light state and EASE1000 V2 state, see "4.3 Indicator".

- BUSY indicator (BUSY)

An LED to indicate the EASE1000 V2 state. It lights up or blinks in yellow.

For the relationship between the indicator light state and EASE1000 V2 state, see "4.3 Indicator".

2.4 Terms of Use

EASE1000 V2 should be used in an environment which meets the following conditions.

Terms of use for EASE1000 V2	
Parameter	Description
Power supply	USB VBUS output (5 V, 500 mA) on the host PC
Usage environment	Temperature: 5 to 40 °C Relative humidity: 30 to 80% (no condensation)
Target LSI Positive power supply (VTref) voltage	Target LSI operation voltage 1.6 to 5.5 V

For an operating environment for software running on the host PC, see the following documents.

- DTU8 User's Manual
- MWU16 Flash Multi Writer Host Program User's Manual

When using EASE1000 V2 as an on-chip emulator or flash writer, the power supply output from EASE1000 V2 to the target LSI is as follows:

Output power supply of EASE1000 V2	
Parameter	Description
Power supply for target LSI (3.3VOUT)	3.3 V (typ) / 100 mA (max)
Power supply for programming Flash ROM (Vpp)	8V (max) / 10mA (max)
Positive power supply for internal logic (VDDL)	When programming the Flash ROM : 2.80V (typ) / 20mA (max) During other debug modes : 1.45V (typ) / 20mA (max)

- The power supply for the target LSI is output after debugging with target LSI by DTU8 debugger or when MWU16 Flash Multi Writer Host Program is in a plug state.
- The power supply for programming Flash ROM (Vpp) is output while the DTU8 debugger or MWU16 Flash Multi Writer Host Program is programming the Flash ROM on the target MCU. (Note 1)
- The power supply for internal logic (VDDL) outputs 1.45V after starting the debug mode with target LSI by the DTU8 debugger or while the MWU16 Flash Multi Writer Host Program is in a plug state.

Also, the EASE1000 outputs 2.80V while programming the Flash ROM on the target MCU by the DTU8 debugger or MWU16 Flash Multi Writer Host Program. (Note 1)

■Note 1■

EASE1000 V2 outputs the power supply for programming Flash ROM and the power supply for internal logic only for target LSIs which need the power.

2.5 Target System Requirements

The target system connected with EASE1000 V2 must meet the following requirements.

Target System requirements	
Item	Description
Interface connector	Must support the EASE1000 V2 interface cable Must have a 14-pin 2.54 mm pitch connector (Compatible connector: HIF3FC-14PA-2.54DSA)
Target LSI Positive power supply (V_{DD}) voltage	1.6 to 5.5V (Note 1)
Power consumption (V_{Tref})	10mA

■Note 1■

- Since the target LSI positive power supply is used for the internal circuit of EASE1000 V2, its power consumption increases when EASE1000 V2 is in use.

Use an appropriate amount of the target system positive power supply while considering the power consumed by EASE1000 V2.

- Do not connect EASE1000 V2 when measure the consumption current of a target system.
The on-chip debugging circuit in target LSI influences, and consumption current increases.

The following shows the power consumption of the V_{Tref} pin used inside EASE1000 V2.

EASE1000 V2 V_{Tref} pin power consumption (except for transient current)	
Target LSI positive power supply (V_{DD}) voltage	Power consumption (max)
+5.5V	10mA
+3.3V	2mA

2.5.1 Target System Board Layout

The following shows a recommended board layout of the EASE1000 V2 interface connector in the target system.

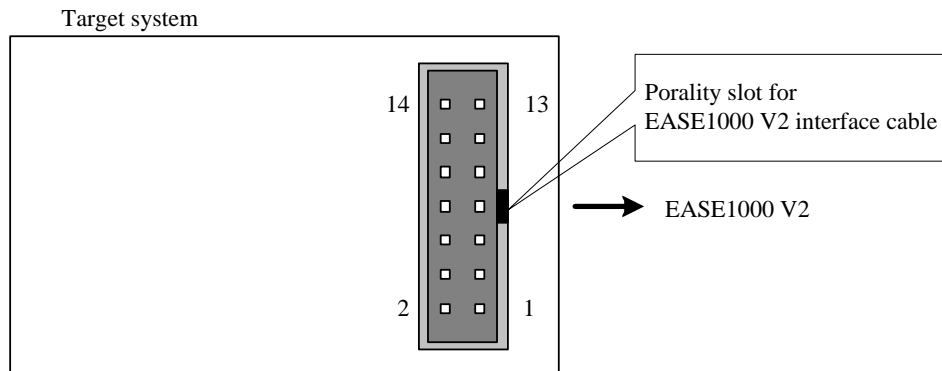

Figure 2-4 EASE1000 V2 Interface Connector Recommended Board Layout

Also, design the pin assignment of the EASE1000 V2 interface connector according to the following table.

Table 1 List of EASE1000 V2 Interface Connector Pins

Pin No.	EASE1000 V2 pin name	Description
1	VTref	Target LSI positive power supply
2	Vss	Target LSI negative power supply
3	Vpp	Target LSI Vpp supply
4	Vss	Target LSI negative power supply
5	RST_OUT/SCK	Target LSI system reset signal/communication clock
6	Vss	Target LSI negative power supply
7	SDATA	Target LSI communication data
8	Vss	Target LSI negative power supply
9	VDDL	Target LSI VDDL supply
10	Vss	Target LSI negative power supply
11	N.C.	Unused (This should be left unconnected.)
12	Vss	Target LSI negative power supply
13	3.3VOUT	3.3V output pin
14	N.C	Unused (This should be left unconnected.)

2.5.2 Target System Circuit Configuration

The circuit configuration to connect a target LSI with EASE1000 V2 is different depending on the specifications of the target LSI. Use an appropriate configuration according to the LSI user's manual.

This section describes some notes when connect a target LSI with EASE1000 V2.

2.5.2.1 ML62Q1000 series is connected as target LSI

- Do not connect the parts which RESET_N pin is fixed to a High level.

A pull-up resistor is connectable to the RESET_N pin. For more details, please refer to Chapter "On chip debug function" in the user's manual for the target LSIs.

- When using P00/TEST0 pin, be sure to set P00 as an input mode by an application program.

If P00 is set as an output mode, it becomes impossible to use EASE1000 V2.

2.5.2.2 ML610QXXX or ML620QXXX is connected as target LSI

2.5.2.2.1 Recommended circuitry using RESET_N pin and TEST pin

- Do not connect the parts which RESET_N pin is fixed to a High level.

A pull-up resistor is connectable to the RESET_N pin. For more details, please refer to Chapter "On chip debug function" in the user's manual for the target LSIs.

- Do not connect any parts to TEST pin.

2.5.2.2.2 Recommended circuitry using TEST1_N pin and TEST0 pin

- Do not connect any parts to TEST1_N pin and TEST0 pin.

- EASE1000 V2 controls reset of a target LSI, do not reset from a RESET_N pin during debugging.

2.5.3 Supplying Target LSI V_{DD}

2.5.3.1 Supplying Target LSI V_{DD} from EASE1000 V2

EASE1000 V2 has the pin (3.3VOUT) to output +3.3 V/100 mA (max) as a target LSI operation power supply.

When this power supply is used, the flash writer, on-chip debug emulator's application program download and software breakpoint functions are available even when the power supply voltage of the target system is set to a value outside the flash memory operation voltage range of the target LSI.

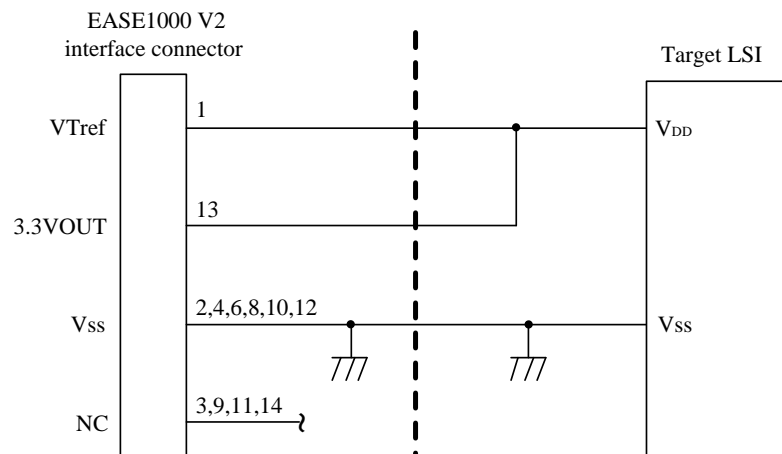

Figure 2-8 Target System Connection Example (3.3VOUT Used)



Note

When using the 3.3VOUT power supply of EASE1000 V2, do not apply power of the target system to the V_{DD} pin of the target LSI. If both power supplies are connected, it may cause fire, electric shock or failure.

2.5.3.2 Outputting Target System Power Supply to Target LSI V_{DD}

The following shows a circuit configuration example for the case of outputting the target system power supply to the target LSI V_{DD} without using 3.3VOUT of EASE1000 V2.

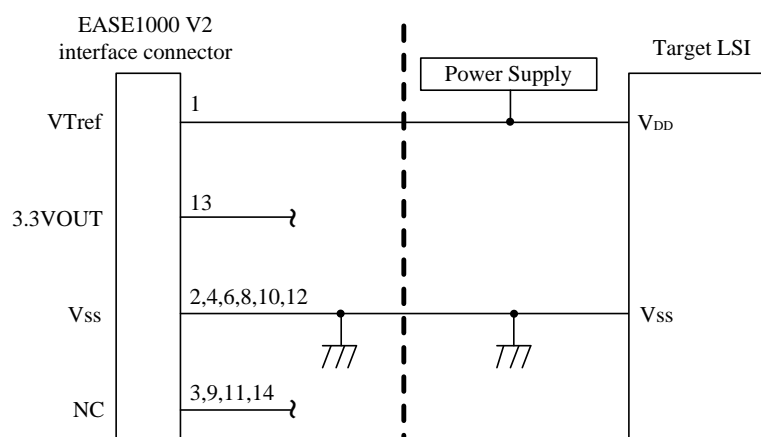

Figure 2-9 Target System Connection Example (3.3VOUT Not Used)



Note

When using the target system power supply, do not connect 3.3VOUT pin and VTref pin. If both pins are connected, it may cause fire, electric shock or failure.

2.5.4 Notes of Target System Board Layout

The following shows the notes of target system board layout

- The length of a cable connecting EASE1000 V2 with the target system (EASE1000 V2 interface cable) is approximately 15 cm. Locate the EASE1000 V2 interface connector at the end of PCB if possible in order to make the cable between the EASE1000 V2 interface connector and target LSI as short as possible.

(Compatible connector: HIF3FC-14PA-2.54DSA)

- It is recommended that the wiring connected to RST_OUT/SCK and SDATA be shielded with Vss

Chapter 3 Start

3 START

3.1 Starting EASE1000 V2

This section describes how to start EASE1000 V2.

For the following software running on the host PC, see the appropriate user's manual.

- DTU8 User's Manual
- MWU16 Flash Multi Writer Host Program User's Manual

3.1.1 Starting Procedure

Start EASE1000 V2 according to the following procedure.

- (1) Connect EASE1000 V2 with the target system through the supplied EASE1000 V2 interface cable.
- (2) Connect EASE1000 V2 with the host PC through the supplied USB cable.

EASE1000 V2 is USB bus-powered. When the USB cable is connected to EASE1000 V2, EASE1000 V2 is turned on, and the POWER indicator on EASE1000 V2 lights up in green.

- (3) Turn on the target system.
- (4) Start the software on the host PC.

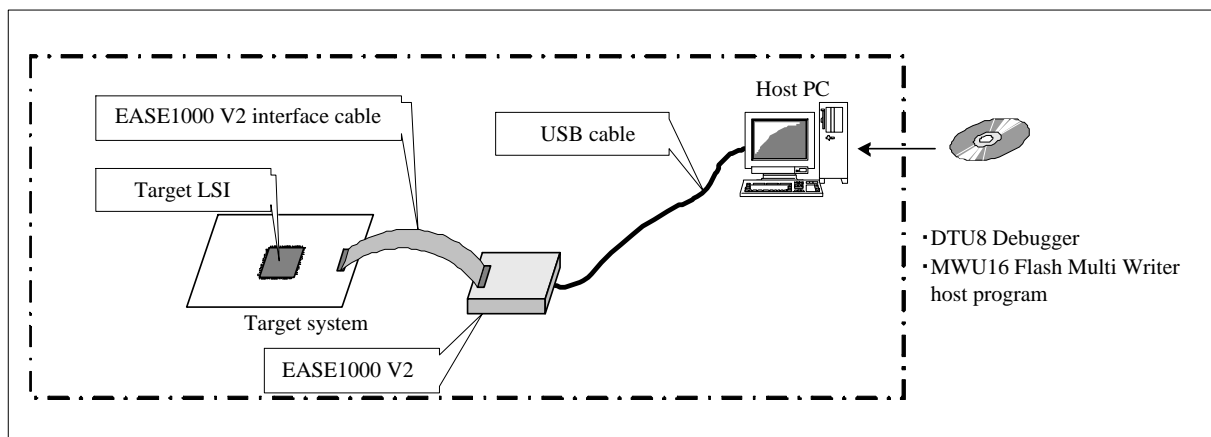

Figure 3-1 EASE1000 V2 System Diagram



Note

Be sure to start according to the starting procedure.
Failing to obey the procedure may cause fire, electric shock or failure.



Note

Be sure to use the cables attached to EASE1000 V2.
Using different cables may cause fire, electric shock or failure.

3.1.2 Removal Procedure

- (1) Close the software on the host PC.
- (2) Turn off the target system.
- (3) Disconnect the USB cable from EASE1000 V2.
- (4) Disconnect the EASE1000 V2 interface cable between EASE1000 V2 and the target system.

**Note**

Be sure to disconnect according to the disconnecting procedure.
Failing to obey the procedure may cause fire, electric shock or failure.

Chapter 4 FUNCTIONS

4 Functions

4.1 On-chip debug function

Connecting EASE1000 V2 with a target LSI and using the DTU8 debugger provides the on-chip debug function.

- Application program download/display/change
- CPU status (register, Flash memory/Data memory, SFR) display/change
- Emulation (real time emulation function, step emulation function)
- Various Break

4.2 Flash writer function

Connecting EASE1000 V2 with a target LSI and using the MWU16 flash multi writer host program provides the flash writer function.

4.3 Indicator

The indicator mounted on EASE1000 V2 notifies of the EASE1000 V2 status.

The following shows the relationship between the EASE1000 V2 state and indicator light state.

Table 4-1 Relationship Table between EASE1000 V2 State and Indicator Light State

EASE1000 V2 state	Indicator type	Indicator light state
Idle state	POWER	On
	BUSY	Off
Emulating	POWER	On
	BUSY	On
Writing flash memory	POWER	On
	BUSY	On
Updating firmware	POWER	Blink (Approximately 0.25-second interval)
	BUSY	On
VTref abnormal voltage detection	POWER	On
	BUSY	Blink (Approximately 0.5-second interval)
Device driver recognition failure	POWER	Blink (Approximately 0.5-second interval)
	BUSY	Blink (Approximately 0.5-second interval)
Command execution error	POWER	Blink (Approximately 0.5-second interval)
	BUSY	Off
Communication error with target LSI	POWER	Blink (Approximately 0.5-second interval)
	BUSY	Blink (Approximately 0.5-second interval, reversed)
Firmware binary error	POWER	Blink (Approximately 0.25-second interval)
	BUSY	Blink (Approximately 0.25-second interval)
EASE1000 V2 failure	POWER	Off
	BUSY	Off

The following describes the above EASE1000 V2 states.

Table 4-2 State explanation of EASE1000 V2

Idle state	Indicates the command reception waiting state from the software on the host PC to EASE1000 V2.
Emulating	Indicates that EASE1000 V2 is emulation state.
Writing flash memory	Indicates that flash memory writing to the target LSI is in progress.
VTref abnormal voltage detection:	Indicates that the voltage level of the target LSI positive power supply (VTref) is out of the guaranteed operation range of EASE1000 V2. Check if there are any problems with the connection with the target system or the power supply output state.
Device driver recognition failure	Indicates that installation of the EASE1000 V2 device driver was not recognized on the host PC when the USB cable was connected with EASE1000 V2 (EASE1000 V2 is powered on). Install the device driver according to the dialog box that appears on the host PC.
Command execution error	Indicates that the command response from the target LSI to EASE1000 V2 was abnormal. Check if there are any problems with the connection with the target system or the command execution order.
Communication error with target LSI	Indicates that EASE1000 V2 does not communicate with the target LSI correctly. Check if there are any problems with the connection with the target system.
Firmware binary error	Indicates that the data of control firmware of EASE1000 V2 is corrupt. Update the firmware. If the error still occurs, contact your dealer or our sales representative.
Updating firmware	Indicates that the control firmware of EASE1000 V2 is being updated. After update, EASE1000 V2 is automatically restarted.
EASE1000 V2 failure	Indicates that EASE1000 V2 is broken. Rapidly disconnect the USB cable of EASE1000 V2 and any other external powers from outlet. Leaving such situation as it might cause fire or electric shock. If there is no problem with the connection with the target system or USB cable, contact your dealer or our sales representative.

Chapter 5 Notes on Use of EASE1000 V2

5 Notes on Use of EASE1000 V2

5.1 Notes on Debug

- (1) About the execution cycle at the wait mode.

On wait mode, STEP execution may differ from the execution cycle of Go- execution.

The final check of an application program should use Go-execution.

- (2) About the RAM Match Break

- The timing of RAM Match Break is after executing a maximum of 3 instruction from the instruction which read/write access of RAM.
- The RAM Match Break of DSR (0F000H) cannot choose.

- (3) About STOP / HALT mode

The all state such as STOP / STOP-D / HALT / HALT-H (hereinafter called STOP / HALT) will become invalid the Force break is used in the state of STOP / HALT.

The state of STOP / HALT is canceled by break when Break-point is set up immediately after the instruction which sets up STOP / HALT.

- (4) About Real-Time-Watch

The Real-Time-Watch of DSR (0F000H) cannot choose.

- (5) About change of the register value of DTU8 debugger

- When high-speed clock operation is chosen for target LSI, the FHWUPT register cannot be changed in the SFR window of DTU8 debugger.
- When following peripheral is changed by DTU8 debugger, it is set as LSI before an emulation start.
 - CPU register: R0, R1, EA, PSW
 - SFR: DSR, FCON

- (6) About the status window of execution time

The accuracy of Timer displayed in the status window of DTU8 is 100us units. The maximum time which can be measured is 119 hours. If the maximum time is exceeded, a count will be continued from 0us.

The value of Timer is measured by the timer of EASE1000 V2. Therefore, it differs from the execution time of LSI. When a measurement period is short, an error of measurement becomes large.

$$\text{Timer value} = \text{Execution time of LSI} \pm 0.2 \% + 300\text{us}$$

5.2 About the 3.3VOUT pin

The specification of the 3.3VOUT pin is 3.3V/100mA.

When using the 3.3VOUT pin with the target system, do not exceed the range of specification.

Using exceeding specification, may damage the target system or EASE1000 V2.

5.3 About Usage Environment

EASE1000 V2 may be affected by the external environment of the host PC, USB cable, EASE1000 V2 interface cable, and the target system. Please check the operation in the specific customer environment before use.

5.4 About Flash Writing

Confirm before using EASE1000 V2 as a flash writer that the target LSI power supply voltage (V_{DD}) is within the operating conditions of the flash memory. When connecting the ML610QXXX or ML620QXXX as target LSI, please confirm that the voltage of flash programming power supply (V_{pp}) and internal logic power supply (V_{DDL}) are also within the operating conditions of the flash memory.

For the operating conditions of flash memory, refer to “Electrical Characteristics -> Operating Conditions of Flash Memory” and “On-Chip Debug Function -> Method of Connecting” in the user's manual for the target LSIs.

Also, please confirm that the application program operates normally after writing.

5.5 About Cables

Be sure to use the USB cable and EASE1000 V2 interface cable supplied as EASE1000 V2 accessories. The operation is not guaranteed if a cable other than the EASE1000 V2 accessories is used.



Note

Be sure to use the cables attached to EASE1000 V2.
Using different cables may cause fire, electric shock or failure.

Chapter 6 Appendices

6. Appendices

6.1 Form information

6.1.1 EASE1000 V2

Item	Description
Outside dimension	50 (W)×17(H)×90(D)[mm]
Weight	50g

6.1.2 EASE1000 V2 Interface cable

Item	Description
Cable length	150[mm]
Connector form	2.54mm pitch 14 pins Two-row socket

6.1.3 USB cable

Item	Description
Cable length	100[cm]
Connector form	host side : USB Type-A EASE1000 V2 side : USB Type-B mini

6.2 EASE1000 V2 Interface Cable Appearance

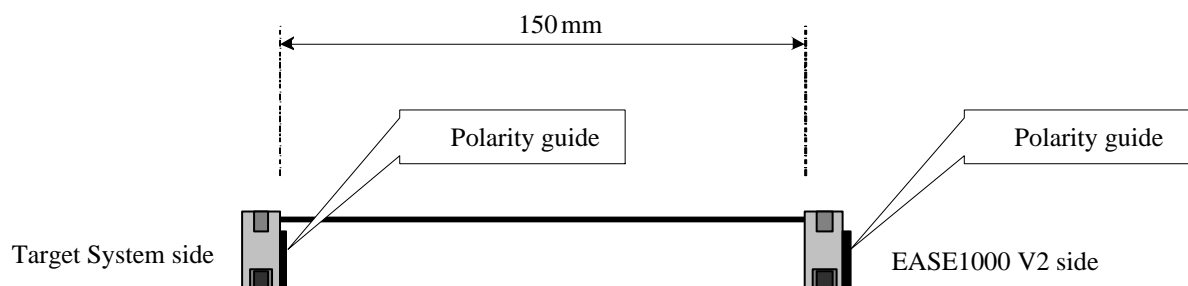

Figure 6-1 EASE1000 V2 Interface Cable Appearance

6.3 Update of Firmware

Please confirm the latest version of firmware at a [LAPIS support site](#).

Please refer to the “Firmware Update function” section of “DTU8 Debugger User’s Manual” for an update procedure.

Revision History

Revision History

Document No.	Date	Page		Description
		Previous Edition	Current Edition	
FEXTEASE1000V2-01	July 20, 2018	-	-	First Edition
FEXTEASE1000V2-02	Feb. 19, 2019	15	17	Described that check the manual of LSI about connection method.
		16	18	Described that check the manual of LSI about connection method.
		27	29	Vpp and VDDL are added to the note about Flash Writing.
FEXTEASE1000V2-03	Mar. 23, 2020	6	6	Add a warning message.
		16	16	Delete a figure of target configuration.
		17	16	Delete a figure of target configuration.
		18	16	Delete a figure of target configuration.
		19	17	Add a note on connection.