

Dear customer

LAPIS Semiconductor Co., Ltd. ("LAPIS Semiconductor"), on the 1<sup>st</sup> day of October, 2020, implemented the incorporation-type company split (shinsetsu-bunkatsu) in which LAPIS established a new company, LAPIS Technology Co., Ltd. ("LAPIS Technology") and LAPIS Technology succeeded LAPIS Semiconductor's LSI business.

Therefore, all references to "LAPIS Semiconductor Co., Ltd.", "LAPIS Semiconductor" and/or "LAPIS" in this document shall be replaced with "LAPIS Technology Co., Ltd."

Furthermore, there are no changes to the documents relating to our products other than the company name, the company trademark, logo, etc.

Thank you for your understanding.

LAPIS Technology Co., Ltd.  
October 1, 2020

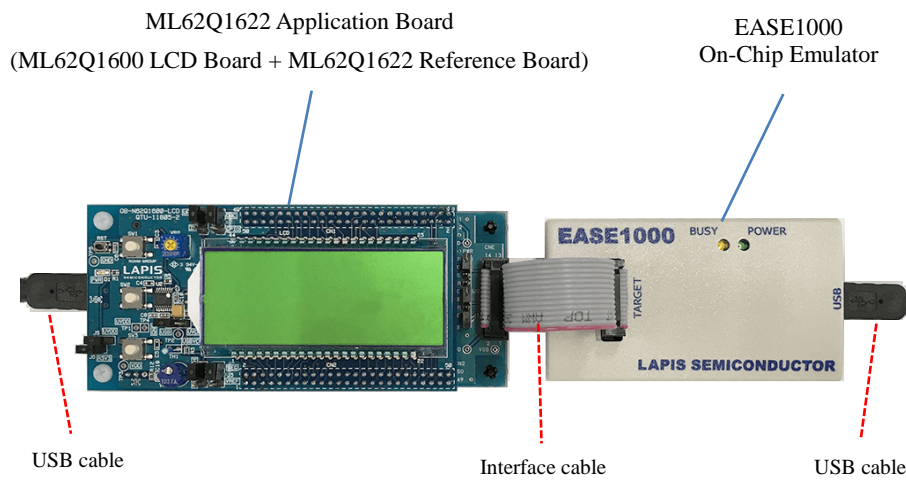

Figure 1 ML62Q1622 LCD Starter Kit hardware configuration

## 1. Installation

Operating environment: Windows Vista\*, Windows 7\*, Windows 8/8.1\*, Windows 10\* \* 32-bit (x86) and 64-bit (x64) version.

- Please log on with an administrator account.
- When U8/U16 Development Tools are existed in your PC, at the beginning, uninstall these programs.  
For uninstallation, refer to step #14.

1-1. Installing the U8/U16 Development Tools software, the Device Information Files and the EASE1000 USB drivers.  
Insert the U8/U16 Development Tools Setup CD into the CD-ROM drive of your PC.  
Run EN\_Setup\_DevTools.BAT located in root directory of the Setup CD.

When this batch file is executed, the U8/U16 Development Tools software's installer, the Device Information File's installer and the EASE1000 USB driver's installer will be invoked in sequence.

(1) Installing the U8/U16 Development Tools software

- Agree to "SOFTWARE LICENSE AGREEMENT for SOFTWARE DEVELOPMENT TOOLS".
- Do not change option settings.
- Click the "Finish" button when you can see the message "The InstallShield Wizard has successfully installed LAPIS semiconductor U8/U16 Development Tools."  
After that, next installation starts automatically.

(2) Installing the Device Information Files

- Agree to "SOFTWARE LICENSE AGREEMENT for SOFTWARE DEVELOPMENT TOOLS".
- Do not change option settings.
- Click the "Finish" button when you can see the message "The InstallShield Wizard has successfully installed LAPIS semiconductor U8/U16 Device Information Files."  
After that, next installation starts automatically.

(3) Installing the EASE1000 USB drivers

- Agree to "SOFTWARE LICENSE AGREEMENT for SOFTWARE DEVELOPMENT TOOLS".
- Do not change option settings.
- Click the "OK" button when you can see the message "Please attach your device to this computer any time after the installation has finished"
- Click the "Finish" button when you can see the message "The InstallShield Wizard has successfully installed LAPIS semiconductor U8/U16 Development Tools Driver."  
After that, U8/U16 Development Tools Release Note is opened automatically.

- Please be sure to read the U8/U16 Development Tools Release Note.
- After that, close this Release Note next.

After that, installation has finished.

Eject the U8/U16 Development Tools Setup CD from the CD-ROM drive of your PC.

## 2. Connection

2-1. As shown in figure 1, connect the ML62Q1622 Application Board to the EASE1000 On-Chip Emulator (hereinafter "EASE1000").  
\*Use the ML62Q1622 Application Board by default settings.

2-2. Connect the EASE1000 to PC using the USB cable.

If you have first connected EASE1000 to PC, the messages of the following Figure 2 and Figure 3 are displayed in sequence.

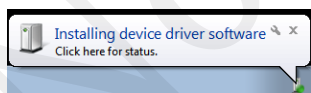

Figure 2 The USB driver installation message 1

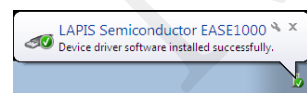

Figure 3 The USB driver installation message 2

2-3. Connect the ML62Q1622 Application Board to PC using the USB cable.

If you have first connected the ML62Q1622 Application Board to PC, the messages of the following Figure 4 and Figure 5 are displayed in sequence.

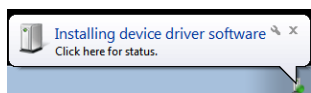

Figure 4 The USB driver installation message 1

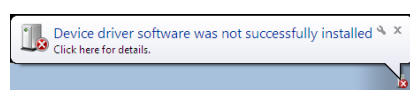

Figure 5 The USB driver installation message 2

- At this point, USB driver for the ML62Q1622 Application Board is not successfully installed yet.
- In this guide, the USB driver is not necessary for only supplying power to the ML62Q1622 Application Board.
- For more details regarding the installation of the USB driver for the ML62Q1622 Application Board, refer to "3. Operating environment" of ML62Q1622 Watch Sample Program Operation Guide which is included a ML62Q1622 LCD Starter Kit CD.

## 3. Launch of the DTU8 debugger

- 3-1. Launch the DTU8 Debugger from the Start Menu (Start Menu > All Programs > U8 Tools > nX-U8 > DTU8 Debugger).
- 3-2. In the "Target Settings" dialog box: Select "ML621622" from LSI list of the "ML62Q1000" Category / "ML62Q1600" Group of "Target chip", and select "On Chip Emulator" from the "Target ICE" list. And Click the <OK> button.

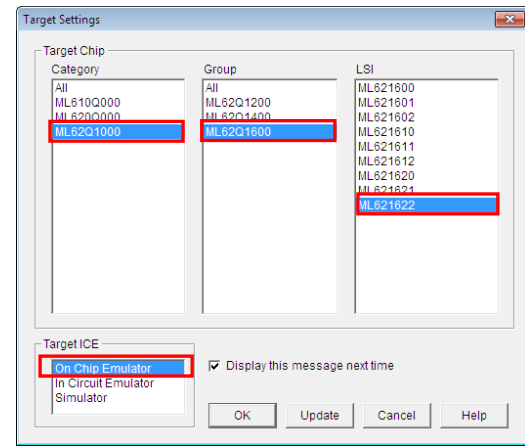

Figure 6 Select the target chip and the target ICE

- 3-3. Click the <OK> button when a confirmation dialog box will be displayed that asks the user whether to start debugging. The DTU8 debugger will start.

## 4. Running the program written in the flash memory

The ML62Q1622 Watch Sample Program is written in at the time of shipment in the flash memory.

- 4-1. Click the <Reset and Restart> button of the DTU8 debugger

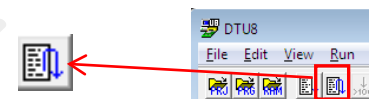

The ML62Q1622 Watch Sample Program will run and blink the display of "CONFIG" and time (PM 11:59:59).



Figure 7 Display of the LCD after clicking the <Reset and Restart> button of the DTU8 debugger

- 4-2. Push the switch "SW1" of the ML62Q1622 Application Board.

The ML62Q1622 Watch Sample Program counts time and displays time on LCD.

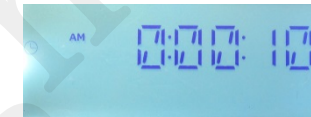

Figure 8 Display of the LCD after pushing the switch "SW1" of the ML62Q1622 Application Board.

## 5. Stop the ML62Q1622 Watch Sample Program

- 5-1. Click the <Stop > button of the DTU8 debugger.

The ML62Q1622 Watch Sample Program will stop.



## 6. Shut down

- 6-1. Choose the File menu Exit menu command of the DTU8 debugger.
- 6-2. Click the <OK> button when a confirmation dialog box will be displayed that asks the user whether to terminate DTU8 debugger.
- 6-3. Click the <No> button when a confirmation dialog box will be displayed that asks the user whether to save current settings to project file.

## 7. Setting the DTU8 Debugger

Set up a privilege level to the DTU8 Debugger.

- 7-1. Display "C:\Program Files (x86)\U8dev\Bin" folder (on 64bit windows) or "C:\Program Files\U8dev\Bin" folder (on 32bit windows). Then select [Property] on the context menu on DTU8 ( or DTU8.exe).

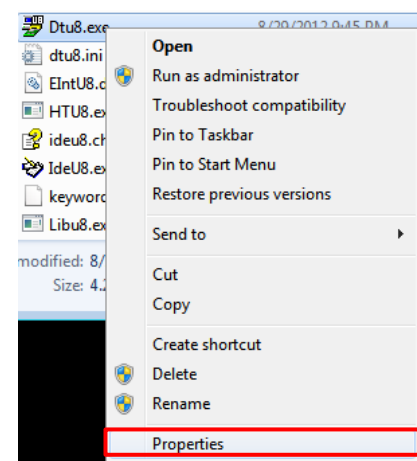

Figure 9 Select [Property] on the context menu on DTU8.exe..

- 7-2. Check [Run this program as an administrator] of [Privilege Level] and click <OK >.

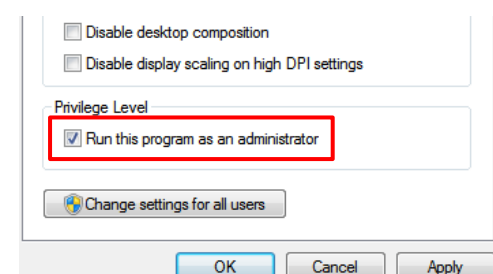

Figure 10 Check [Run this program as an administrator].

## 8. Installing the ML62Q1622 Watch Sample Program

- 8-1. Insert the ML62Q1622 LCD Starter Kit CD into the CD-ROM drive of your PC.
- 8-2. Copy the ML62Q1622\_LCD\_StarterKit.zip from CD to desktop of your PC.
  - Please copy the ML62Q1622\_LCD\_StarterKit.zip on the folder which contains using half-width characters except space.

Eject ML62Q1622 LCD Starter Kit CD from the CD-ROM drive of your PC.

## 9. Open of the ML62Q1622 Watch Sample Program project and build

- 9-1. Launch the Integrated Development Environment "IDEU8" (hereinafter "IDEU8") from the Start Menu (Start Menu > All Programs > U8 Tools > nX-U8 > IDEU8 GUI Environment).
- 9-2. Choose the File menu Open... menu command of the IDEU8.
- 9-3. In the "Open File" dialog box: Select the ML62Q1622\_WatchSample.PID in the "ML62Q1622\_LCD\_StarterKit \ ML62Q1622\_WatchSample" folder and click <Open>. The project file of the ML62Q1622 Watch Sample Program (hereinafter "Watch Sample Program") will be opened.
- 9-4. Click the <Build> button to compile, assemble and link the Sample Program.

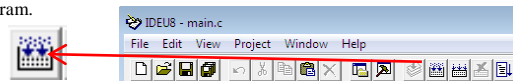

You will be able to see the message "Finished building."

## 10. Launch of the DTU8 debugger and loading the Watch Sample Program

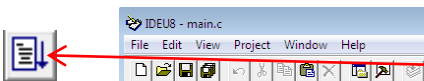
- 10-1. Click the <Debug> button to launch the DTU8 debugger
- 
- 10-2. In the "Target Settings" dialog box: Select "ML621622" from LSI list of the "ML62Q1000" Category / "ML62Q1600" Group of "Target chip", and select "On Chip Emulator" from the "Target ICE" list. And Click the <OK> button.

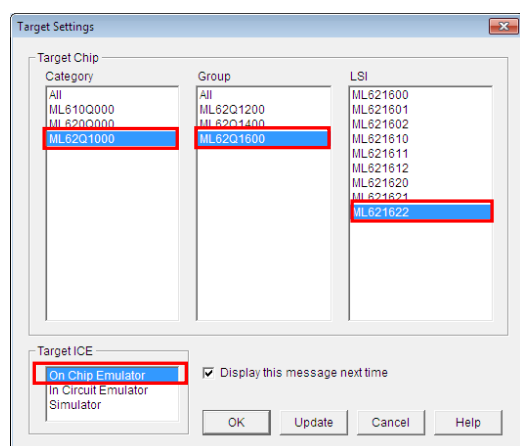

Figure 11 Select the target chip and the target ICE

- 10-3. Click the <OK> button when a confirmation dialog box will be displayed that asks the user whether to start debugging. The DTU8 debugger will start and load the Watch Sample Program.

## 11. Run of the Watch Sample Program

- 11-1. Click the <Reset and Restart> button of the DTU8 debugger



The Watch Sample Program will run and blink the display of "CONFIG" and time (PM 11:59:59).



Figure 12 Display of the LCD after clicking the <Reset and Restart> button of the DTU8 debugger

- 11-2. Push the switch "SW1" of the ML62Q1622 Application Board.

The Watch Sample Program counts time and displays time on LCD.

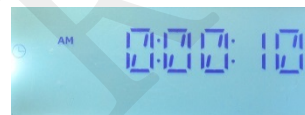

Figure 13 Display of the LCD after pushing the switch "SW1" of the ML62Q1622 Application Board.

## 12. Stop of the Watch Sample Program

- 12-1. Click the <Stop> button of the DTU8 debugger. The Watch Sample Program will stop.



## 13. Shut down

- 13-1. Choose the File menu Exit menu command of the DTU8 debugger.
- 13-2. Click the <OK> button when a confirmation dialog box will be displayed that asks the user whether to terminate DTU8 debugger.
- 13-3. Click the <No> button when a confirmation dialog box will be displayed that asks the user whether to save current settings to project file.
- 13-4. Choose the File menu Exit IDEU8 menu command of the IDEU8
- 13-5. Click the <OK> button when a confirmation dialog box will be displayed that asks the user whether to stop IDEU8.
- 13-6. Disconnect the USB cable which is connected to the ML62Q1622 Application Board from your PC.
- 13-7. Disconnect the USB cable which is connected to the EASE1000 from your PC.

## 14. Uninstallation

- Uninstalling U8/U16 Development Tools Release 1.15.5 or later

In order to uninstall, you should select the following programs from "Add or Remove Programs" of Control Panel.

- U8/U16 Development Tools software : LAPIS Semiconductor U8/U16 Development Tools
- U8/U16 Device Information Files : LAPIS Semiconductor U8/U16 Device Information Files
- USB drivers : U8/U16 Development Tools Driver

- Uninstalling U8/U16 Development Tools Release 1.15.4 or earlier

In order to uninstall, you should select the following programs from "Add or Remove Programs" of Control Panel.

- U8/U16 Development Tools software : LAPIS Semiconductor U8/U16 Development Tools
- U8/U16 Device Information Files : LAPIS Semiconductor U8/U16 Device Information Files

## 15. The Software Development Support System

When you need the latest version of the U8/U16 Development Tools software and ML62Q1000 and the ML62Q1000 Series Reference Software, you can download the latest version from "LAPIS Semiconductor support site" (hereinafter "Support Site") is a special website that gives registered users.

Registration is required to access the site using an ID and Password.

Navigate to the support page by clicking on a link on LAPIS Semiconductor's home page or by entering the URL in the browser's address bar. Then click on the 'Register' link.

LAPIS Semiconductor support site URL

<https://www.lapis-semi.com/cgi-bin/MyLAPIS/regi/login.cgi>

\* In order to download the software such as the software development support system, you need to register the serial number of the EASE1000 at the time of registration.

At the time of registration, select "Microcontroller / speech Synthesis LSI", "EASE1000" and type "The serial number of EASE1000" as follows.

Category: Microcontroller / speech Synthesis LSI

Development/evaluation tool name: EASE1000

The serial number of development tool: The serial number of EASE1000